



**CUPRA** A T E C A

Owner's manual



## Vehicle identification data

Model:
Vehicle Registration:
Vehicle identification number:
Date of vehicle registration or vehicle delivery:
SEAT Official Service:
Service advisor:
Telephone:

## Confirmation of receipt of documentation and vehicle keys

The following items were delivered with the vehicle:	YES	NO
On-board documentation	<input type="checkbox"/>	<input type="checkbox"/>
First key	<input type="checkbox"/>	<input type="checkbox"/>
Second key	<input type="checkbox"/>	<input type="checkbox"/>
Correct working order of all keys was checked	<input type="checkbox"/>	<input type="checkbox"/>
Location:		
Date:		
Signature of owner:		

## Introduction

Thank you for your trust choosing a CUPRA vehicle.

With your new CUPRA, you will be able to enjoy a vehicle with state-of-the-art technology and top quality features.

We recommend reading this Instruction Manual carefully to learn more about your vehicle so you can enjoy all its benefits in your daily driving.

Information about handling is complemented with instructions regarding the operation and maintenance of the vehicle in order to ensure its safety and maintain its value. Moreover, we want to give you valuable advice and tips to drive your vehicle efficiently and respecting the environment.

We wish you safe and enjoyable motoring.

## CUPRA

### **WARNING**

**Read and always observe safety information concerning the passenger's front airbag >>> page 30, Fitting and using child seats.**

## About this manual

This manual describes the **features** of the vehicle at the time of drafting this text. Some of the features described below will be introduced in the future or will only be available in certain markets.

**Some of the features described here are not included in all the types or variations of the model and they can be varied or modified based on technical or marketing requirements without it being considered misleading advertising.**

Some details on the **drawings** may vary from its vehicle and must be interpreted as a standard representation.

The **direction indicators** (left, right, forwards, backwards) in this manual refer to the travel direction of the vehicle unless otherwise stated.

The **audiovisual material** is only meant to help the users better understand some features of the car. It is not a replacement for the instruction manual. Access the instruction manual to see the complete information and warnings.

★ The **features marked with an asterisk** are included by default only in certain versions of the model, supplied as optional only for certain versions or only offered in certain countries.

- Ⓜ **Trademarks** are marked with ®. The absence of this symbol does not guarantee that the term is not a trademark.
- >> It indicates that the section continues on the next page.

You can access the information in this manual using:

- Thematic table of contents that follows the manual's general chapter structure.
- Visual table of contents that uses graphics to indicate the pages containing "essential" information, which is detailed in the corresponding chapters.
- Alphabetical index with many terms and synonyms to help you find information.

### **WARNING**

**Texts after this symbol contain information about safety and warn you about possible accident or injury risks.**

### **CAUTION**

**Texts after this symbol indicate possible damage to the vehicle.**

### **For the sake of the environment**

**Texts after this symbol contain information about the protection of the environment.**

### **Note**

**Texts after this symbol contain additional information.**

## **Printed and digital instruction manual**

The printed instruction manual contains relevant information about the use of the vehicle and the Infotainment System.

The digital version of the manuals contains more in-depth information about the infotainment system.

# Frequently Asked Questions

## Before driving

How do you adjust the seat? »» page 120

How do you adjust the steering wheel?  
»» page 14

How do you adjust the exterior mirrors?  
»» page 117

How do you turn on the exterior lights?  
»» page 107

How does the automatic gearbox selector lever work? »» page 232

How do you refuel? »» page 313

How do you activate the windscreen wipers and windscreen washer system? »» page 114

## Emergency situations

A warning lamp lights up or flashes. What does this mean? »» page 77

How do you open the bonnet? »» page 318

How do you perform a jump start? »» page 46

Where is the vehicle tool kit located?  
»» page 38

How do you repair a tyre with the anti-puncture kit? »» page 40

How do you change a wheel? »» page 41

How do you change a fuse? »» page 52

How do you change a light? »» page 56

How do you tow a vehicle? »» page 48

## Useful tips

How do you set the time? »» page 73

When should the vehicle inspection should be performed? »» page 75

What functions do the buttons/thumbwheels on the steering wheel perform? »» page 83

How do you remove the luggage compartment cover? »» page 126

How do you drive in an economical and environmentally-friendly way? »» page 244

How do you check and top up the engine oil?  
»» page 319

How do you check and top up the engine coolant? »» page 322

How do you top up the windscreen washer fluid?  
»» page 325

How do you check and top up the brake fluid?  
»» page 324

How do you check and adjust tyre pressure values? »» page 333

Vehicle washing tips »» page 343

## Functions of interest

Easy Connect, Car menu »» page 80

How does the START-STOP system work?  
»» page 230

What parking assistants are available?  
»» page 283

How does the rear assist work? »» page 300

How does the adaptive cruise control work?  
»» page 255

How can the driving mode be adjusted?  
»» page 241

How does the lane departure warning system work? »» page 263

How does tyre pressure monitoring work?  
»» page 337

How do you open the vehicle without a key (Keyless Access)? »» page 90

Interior lighting and ambient light »» page 114

# Table of Contents

<b>General views of the vehicle</b> .....	7	<b>Operation</b> .....	61	Drink holder .....	134
<b>Exterior view</b> .....	7	<b>Controls and displays</b> .....	61	Power sockets .....	135
<b>Overview (left hand drive)</b> .....	8	Interior view .....	61	<b>Air conditioning</b> .....	137
<b>Overview (right hand drive)</b> .....	9	<b>Instruments and warning/control lamps</b> .....	62	Heating, ventilation and cooling .....	137
<b>Interior view</b> .....	10	Instrument panel .....	62	<b>Infotainment System</b> .....	144
<b>Safety</b> .....	11	Using the instrument panel .....	76	<b>Introduction</b> .....	144
<b>Safe driving</b> .....	11	Control lamps .....	77	Safety warnings .....	144
Advice about driving .....	11	Easy Connect system .....	80	Overview of the unit .....	146
Correct sitting position of vehicle occupants .....	12	Multifunction steering wheel .....	83	General instructions for use .....	150
Pedal area .....	14	<b>Opening and closing</b> .....	85	Voice control .....	156
<b>Seat belts</b> .....	15	Set of vehicle keys .....	85	<b>Connectivity</b> .....	160
The whys and wherefores of seat belts .....	15	Central locking .....	87	Data transfer .....	160
How to properly adjust your seat belt .....	18	Anti-theft alarm system* .....	93	Full Link* .....	160
Seat belt tensioners .....	20	Doors .....	96	Media Control* .....	166
<b>Airbag system</b> .....	21	Rear lid .....	98	WLAN access point* .....	167
Brief introduction .....	21	Window controls .....	102	<b>Operating modes</b> .....	170
Operation of the airbags .....	23	Sunroof* .....	104	Radio .....	170
<b>Transporting children safely</b> .....	28	<b>Lights</b> .....	107	Media .....	177
Safety for children .....	28	Vehicle lighting .....	107	Navigation .....	195
<b>Emergencies</b> .....	38	Interior lights .....	114	Navigation in Offroad mode* .....	207
<b>Self-help</b> .....	38	<b>Visibility</b> .....	114	Vehicle Menu .....	209
Emergency equipment .....	38	Windscreen wiper and rear window wiper systems .....	114	Telephone .....	213
Tyre repairs .....	38	Mirrors .....	117	Multimedia .....	224
Changing a wheel .....	41	Sun protection .....	119	<b>Driving</b> .....	226
Changing the windscreen wiper blades .....	45	<b>Seats and headrests</b> .....	120	<b>Start and driving</b> .....	226
Jump start .....	46	Adjusting seats .....	120	Starting and stopping the engine .....	226
Tow start and towing .....	48	Headrest .....	121	Start-Stop system .....	230
<b>Fuses and bulbs</b> .....	52	Seat functions .....	123	DSG automatic transmission .....	232
Fuses .....	52	<b>Transport and practical equipment</b> .....	124	Gear-change recommendation .....	239
Changing bulbs .....	56	Storing objects .....	124	Hill Descent Control (HDC) .....	239
		Luggage compartment .....	126	Steering .....	240
		Roof carrier* .....	131	Driving modes (Drive Profile)* .....	241
		Storage compartment .....	132	Driving tips .....	243

## Table of Contents

<b>Driver assistance systems</b> .....	246	Engine oil .....	319
Cruise control system (CCS)* .....	246	Cooling system .....	322
Speed limiter .....	248	Brake fluid .....	324
Emergency brake assistance system (Front Assist)* .....	251	Windscreen washer reservoir .....	325
ACC - Adaptive Cruise Control* .....	255	Battery .....	326
Lane Assist* .....	263	Energy management .....	328
Traffic Jam Assist .....	266	<b>Wheels</b> .....	330
Emergency Assist .....	268	Wheels and tyres .....	330
Using the blind spot detector (BSD) with parking assistant (RCTA)* .....	269	Tyre pressure loss indicator .....	337
<b>Braking and parking</b> .....	274	Spare wheel .....	338
Braking system .....	274	<b>Maintenance</b> .....	340
Stabilisation and brake assistance systems .....	279	<b>Service</b> .....	340
Parking .....	282	Service intervals .....	340
<b>Help with parking and manoeuvring</b> .....	283	Additional service offers .....	342
Assisted parking system (Park Assist)* .....	283	Warranty .....	343
Parking aid parking and manoeuvring (ParkPi-lot) .....	290	<b>Vehicle maintenance</b> .....	343
Parking System Plus* .....	291	Maintenance and cleaning .....	343
Rear parking aid* .....	294	<b>Accessories and modifications to the vehicle</b> .....	348
Peripheral view system (Top View Camera)* .....	296	Accessories, spare parts and repair work .....	348
Reverse Assist (Rear View Camera)* .....	300	<b>Information for the user</b> .....	351
<b>Towing bracket device*</b> .....	303	<b>Information for the user</b> .....	351
Trailer mode .....	303	Information stored by the control units .....	351
Electrically unlocking trailer hook* .....	310	Other important information .....	351
Retrofitting a towing bracket .....	312	Information about the EU Directive 2014/53/EU .....	352
<b>Practical tips</b> .....	313	<b>Technical data</b> .....	355
<b>Checking and refilling levels</b> .....	313	<b>Indications about the technical data</b> .....	355
Refuelling .....	313	Important information .....	355
Fuel types .....	314	<b>Index</b> .....	361
Engine management and emissions control system .....	315		
Engine compartment .....	316		



## Exterior view

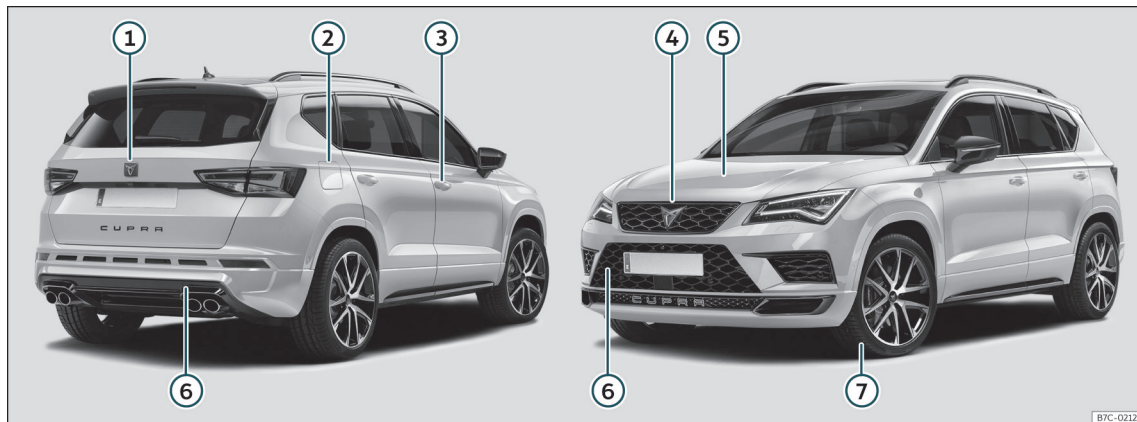

B7C-0212

### ① Rear lid

- Opening from outside >>> page 98
- Emergency opening >>> page 102

### ② Fuel tank

- Fuel capacity >>> page 355
- Open/Close cap >>> page 313

### ③ Opening and closing

- Doors >>> page 96

- Central locking >>> page 87

- Manual release >>> page 96

### ④ Bonnet

- Unlocking lever >>> page 318

- Open/close >>> page 318

### ⑤ Levels control

- Oil >>> page 319

- Brake fluid >>> page 324

- Battery >>> page 326

### ⑥ Towing the vehicle

- Towline anchorage >>> page 51

- Tow start >>> page 48

### ⑦ Action in the event of a puncture

- Anti-puncture kit >>> page 38

- Wheel change >>> page 41

## Overview (left hand drive)

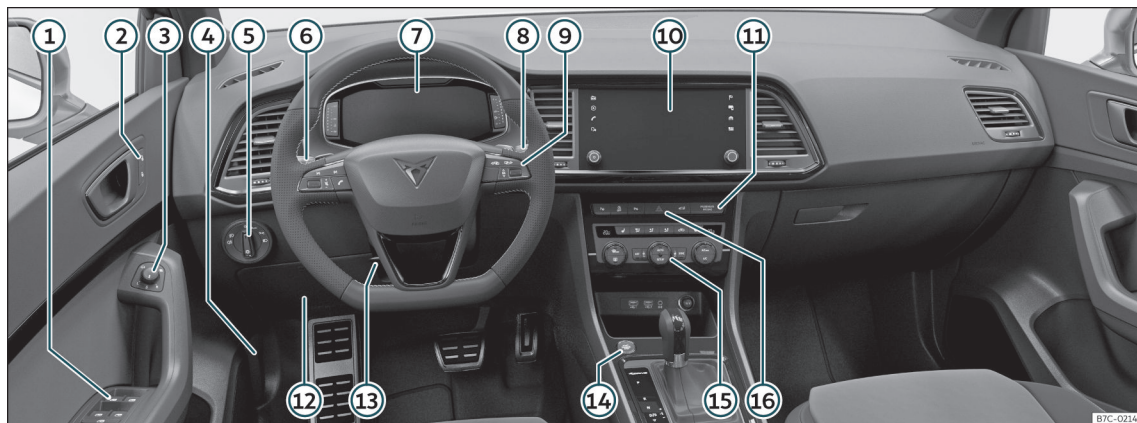

① Electric windows >>> page 102

② Central locking >>> page 87

③ Exterior mirror adjustment >>> page 117

④ Open bonnet lever >>> page 318

⑤ Headlight switch >>> page 107

⑥ Turn signal and main beam lever  
>>> page 109

Cruise control >>> page 246

⑦ Warning lamps >>> page 77

⑧ Wipers and rear window wiper  
>>> page 114

⑨ Driver information system >>> page 76

⑩ Easy Connect >>> page 80

⑪ Front passenger airbag disconnection  
display >>> page 25

⑫ Fuses >>> page 52

⑬ Steering wheel adjustment >>> page 14

⑭ Starter button >>> page 226

⑮ Air conditioning >>> page 137

⑯ Hazard warning lights >>> page 112

## Overview (right hand drive)

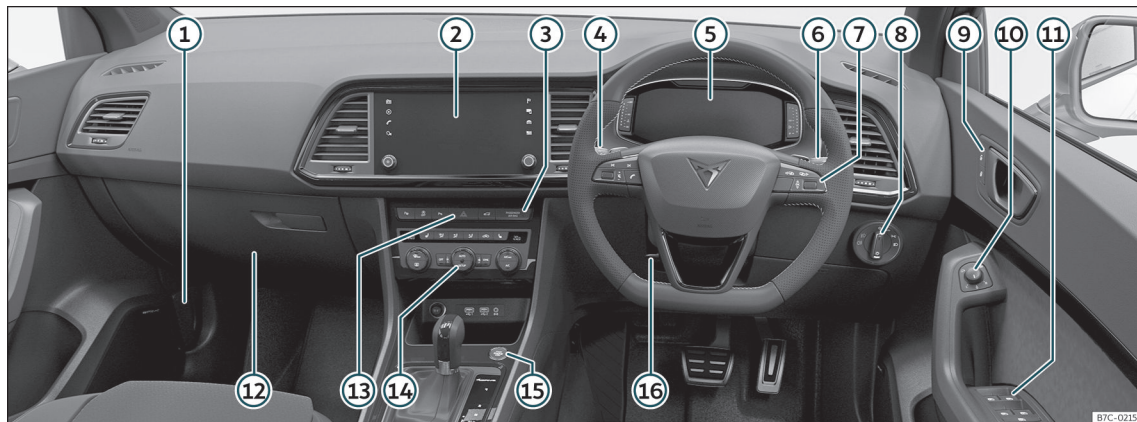

- |   |  |  |
|---|--|--|
| ① Open bonnet lever »» page 318                           | ⑤ Warning lamps »» page 77                 | ⑪ Electric windows »» page 102         |
| ② Easy Connect »» page 80                                 | ⑥ Wipers and rear window wiper »» page 114 | ⑫ Fuses »» page 52                     |
| ③ Front passenger airbag disconnection display »» page 25 | ⑦ Driver information system »» page 76     | ⑬ Hazard warning lights »» page 112    |
| ④ Turn signal and main beam lever »» page 109             | ⑧ Headlight switch »» page 107             | ⑭ Air conditioning »» page 137         |
| Cruise control »» page 246                                | ⑨ Central locking »» page 87               | ⑮ Starter button »» page 226           |
|   | ⑩ Exterior mirror adjustment »» page 117   | ⑯ Steering wheel adjustment »» page 14 |

## Interior view

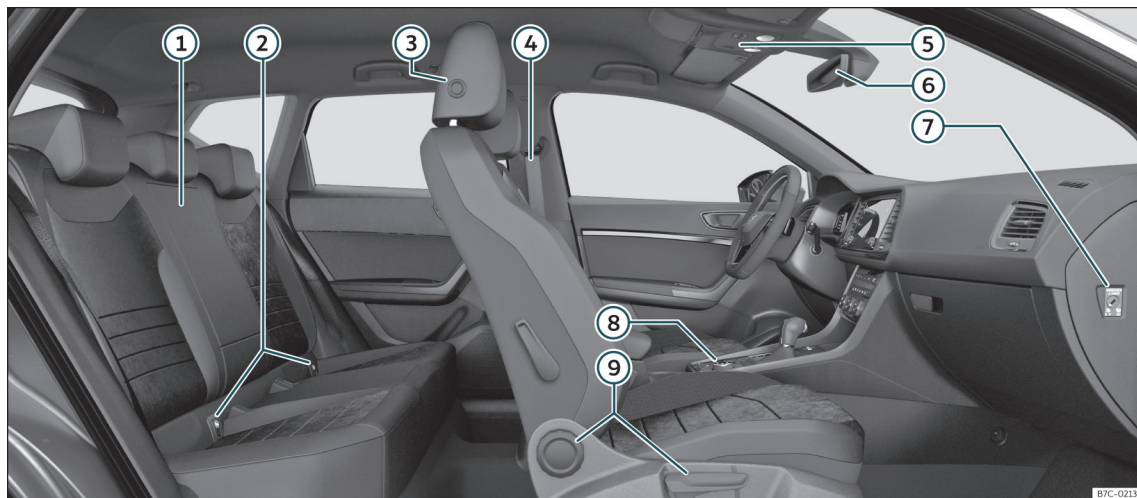

① Armrest >>> page 130

② Isofix anchors >>> page 31

③ Headrest adjustment >>> page 121

④ Seat belts >>> page 15

⑤ Panoramic roof >>> page 104

⑥ Interior mirror >>> page 117

⑦ Disconnecting the front passenger front airbag >>> page 25

⑧ Electronic parking brake >>> page 276

⑨ Seat adjustment >>> page 120

## Safety

### Safe driving

#### Advice about driving

##### Safety first!

##### WARNING

- This manual contains important information about the operation of the vehicle, both for the driver and the passengers. The other sections of the on-board documentation also contain further information that you should be aware of for your own safety and for the safety of your passengers.
- Ensure that the on-board documentation is kept in the vehicle at all times. This is especially important when lending or selling the vehicle to another person.

##### Before driving

For your own safety and the safety of your passengers, always note the following points before every trip:

- Make sure that the vehicle's lights and turn signals are working properly.
- Check tyre pressure.

- Ensure that all windows provide a clear and good view of the surroundings.
- Make sure all luggage is secured >>> page 124.
- Make sure that no objects can interfere with the pedals.
- Adjust front seat, headrest and mirrors properly according to your size.
- Ensure that the passengers in the rear seats always have the headrests in the in-use position >>> page 121.
- Instruct passengers to adjust the headrests according to their height.
- Protect children with appropriate child seats and properly applied seat belts >>> page 28.
- Assume the correct sitting position. Instruct your passengers also to assume a proper sitting position >>> page 12.
- Fasten your seat belt securely. Instruct your passengers also to fasten their seat belts properly >>> page 15.
- Always pay attention to traffic and do not get distracted by passengers or telephone calls.
- Never drive when your driving ability is impaired (e.g. by medication, alcohol, drugs).
- Observe traffic laws and speed limits.
- Always reduce your speed as appropriate for road, traffic and weather conditions.
- When travelling long distances, take breaks regularly - at least every two hours.
- If possible, avoid driving when you are tired or stressed.

##### WARNING

Driving under the influence of alcohol, drugs, medication or narcotics may result in severe accidents and even loss of life.

- Alcohol, drugs, medication and narcotics may significantly alter perception, affect reaction times and safety while driving, which could result in the loss of control of the vehicle.

##### Safety equipment

Never put your safety or the safety of your passengers in danger. In the event of an accident, the safety equipment may reduce the risk of injury. The following points cover »

##### Factors influencing safety

As a driver, you are responsible for yourself and your passengers.

part of the safety equipment in your CU-PRA<sup>1)</sup>:

- three-point seat belts,
- belt tension limiters for the front and rear side seats,
- belt tensioners for the front and rear side seats,
- front airbags,
- knee airbags,
- side airbags in the front seat backrests,
- head-protection airbags,
- "ISOFIX" anchor points for "ISOFIX" rear child seat system
- height-adjustable front headrests,
- rear headrests with in-use position and non-use position,
- adjustable steering column.

The safety equipment mentioned above works together to provide you and your passengers with the best possible protection in the event of an accident. However, these safety systems can only be effective if you and your passengers are sitting in a correct position and use this equipment properly.

**Safety is everyone's business!**

## Correct sitting position of vehicle occupants

### Correct position on the seat

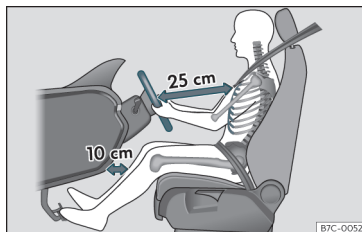

**Fig. 1** The correct distance between the driver and the steering wheel must be at least 25 cm (10 inches).

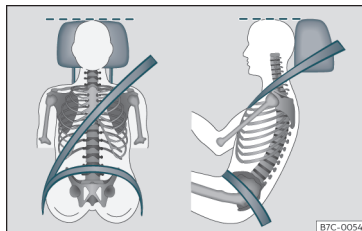

**Fig. 2** Correct belt web and headrest positions

The correct sitting positions for the driver and passengers are shown below.

If your physical constitution prevents you from maintaining the correct sitting position, contact a specialised workshop for help with any special devices. The seat belt and airbag can only provide optimum protection if a correct sitting position is adopted. CUPRA recommends taking your car in for technical service.

For your own safety and to reduce the risk of injury in the event of an accident or sudden braking or manoeuvre, CUPRA recommends the following positions:

### Valid for all vehicle occupants:

- Adjust the headrest so that its upper edge is at the same level as the top of your head, or as close as possible to the same level as the top of your head and under no circumstances below eye level. Keep the back of your neck as close as possible to the headrest »» **Fig. 2.**
- Short people must lower the headrest completely, even if your head is below its upper edge.
- Tall people must raise the headrest completely.

<sup>1)</sup> Depending on the version/market.

- Always keep your feet in the footwell while the vehicle is in motion.
- Adjust and fasten your seat belt correctly  
»» page 18.

### The following also applies to the driver:

- Move the seat backrest to an almost upright position so that your back rests completely against it.
- Move the steering wheel so it is at least 25 cm (10 inches) away from the steering wheel »» **Fig. 1** and you can hold it with both hands on both sides, on the outer part, with your arms slightly bent.
- The steering wheel must always point towards the chest and never towards the face.
- Move the seat in such a way that you can step on the pedals with your knees slightly bent and with a distance between the knees and the dashboard of at least 10 cm (4 inches) »» **Fig. 1**.
- Adjust the height of the seat so that you can reach the top of the steering wheel.
- Always keep both feet in the footwell so that you have the vehicle under control at all times.

### For the passenger, the following applies:

- Move the seat backrest to an almost upright position so that your back rests completely against it.

- Move the seat as far back as possible (minimum 25 cm between the chest and the dashboard check translation). If you are sitting closer than 25 cm, the airbag system cannot protect you properly.

### Number of seats

The vehicle has **5** seats, 2 in the front and 3 in the rear. All seats are equipped with a safety belt.

In some versions, your vehicle is approved **only** for 4 seats. 2 front seats and 2 rear seats.

### WARNING

Sitting in an incorrect position may increase the risk of severe or lethal injuries in the event of sudden braking or manoeuvring, in case of collision or accident and if the airbags deploy.

- Before starting the car, all passengers must be sitting in a correct position and stay like that for the entire journey. This also applies to a correct use of the seat belt.
- The maximum amount of people in the vehicle is the same as the amount of seats with seat belts.
- For children, always use a certified protection system, certified and suited for their weight and height »» page 28.

- While driving, always keep your feet in the footwell. Never place them over the seat or the dashboard, for example, or outside the window. Otherwise the airbag and seat belt may offer insufficient protection and also increase the risk of injury in the event of an accident.

### Risks of sitting in an incorrect position

If seat belts are worn incorrectly or not at all, the risk of severe or lethal injuries increases. Seat belts can provide optimal protection only if the belt web is properly worn. Incorrect sitting positions substantially reduce the protective function of seat belts and, therefore, increase the risk of severe or even lethal injuries. The risk of severe or fatal injuries is especially heightened when a deploying airbag strikes a vehicle occupant who has assumed an incorrect sitting position. The driver is responsible for all people, particularly children, inside the vehicle.

The following list contains examples of incorrect sitting positions that could be dangerous for all vehicle occupants.

### When the vehicle is in motion:

- Never stand in the vehicle.
- Never stand on the seats.
- Never kneel on the seats.

- Never tilt your seat backrest too far to the rear.
- Never lean against the dash panel.
- Never lie on the rear seats.
- Never sit on the front edge of a seat.
- Never sit sideways.
- Never lean out of a window.
- Never put your feet out of a window.
- Never put your feet on the dash panel.
- Never place your feet on the bench or on the backrest of the seat.
- Never travel in a footwell.
- Never sit on the armrests.
- Never travel without wearing the seat belt.
- Never travel in the luggage compartment.

### **⚠ WARNING**

Sitting in an incorrect position increases the risk of severe or fatal injuries in the event of accidents and sudden braking or manoeuvres.

- All occupants must sit correctly during the journey and wear the seat belt correctly.
- Occupants of the vehicle that are not sitting correctly, not wearing the seat belt or are not at a proper distance of the airbag risk suffering very serious or lethal injuries, especially if the airbags deploy and strike them.

### Steering wheel position adjustment

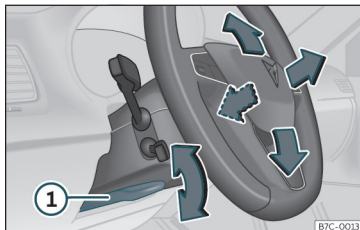

**Fig. 3** Lever in the lower left side of the steering column.

Adjust the steering wheel before your trip and only when the vehicle is stationary.

- Pull the >>> **Fig. 3 1** lever down, move the steering wheel to the desired position and lift the lever back up until it locks.

### **⚠ WARNING**

Incorrect use of the steering wheel adjustment function and an incorrect adjustment of the steering wheel can result in severe or fatal injury.

- After adjusting the steering column, push the lever >>> **Fig. 3 1** firmly upwards to ensure the steering wheel does not accidentally change position while driving.
- Never adjust the steering wheel while the vehicle is in motion. If you need to adjust the steering wheel while the vehicle is in

motion, stop safely and make the proper adjustment.

- The adjusted steering wheel should be facing your chest and not your face so as not to hinder the driver's front airbag protection in the event of an accident.
- When driving, always hold the steering wheel with both hands on the outside of the ring at the 9 o'clock and 3 o'clock positions to reduce injuries when the driver's front airbag deploys.
- Never hold the steering wheel at the 12 o'clock position or in any other manner (e.g. in the centre of the steering wheel). In such cases, if the driver's airbag deploys, you may sustain injuries to your arms, hands and head.

### Pedal area

#### Pedals

- Ensure that you can always press the accelerator, brake and clutch pedals unimpaird to the floor.
- Ensure that the pedals can return unimpaird to their initial positions.
- Ensure that the floor mats are securely fastened during the trip and do not obstruct the pedals >>> **⚠**.



Only use floor mats which leave the pedals clear and which are secured to prevent them from slipping. You can obtain suitable floor mats from a specialised dealership. Fasteners\* for floor mats are fitted in the footwells.

If a brake circuit fails, the brake pedal must be pressed down thoroughly in order to stop the vehicle.

### Wear suitable footwear

Always wear shoes which support your feet properly and give you a good feeling for the pedals.

#### WARNING

- Restricting pedal operation can lead to critical situations while driving.
- Never lay or fit floor mats or other floor coverings over the original floor mats. This would reduce the pedal area and could obstruct the pedals. Risk of accident.
- Never place objects in the driver footwell. An object could move into the pedal area and impair pedal operation.

## Seat belts

### The whys and wherefores of seat belts

#### Control lamps



It lights up red

Driver or passenger has not fastened seat belt.

The control lamp  lights up to remind the driver to fasten their seat belt.

Before starting the vehicle:

- Fasten your seat belt securely.
- Instruct your passengers to fasten their seat belts properly before driving off.
- Protect children by using a child seat according to the child's height and weight >>> page 28.

When starting to drive, if the vehicle's speed exceeds approx. 25 km/h (15 mph) and the seat belts are not fastened or are unfastened while driving, a warning sound will be heard for a few seconds. The warning light will also flash .



The lamp  goes out when the driver and passenger seat belts are fastened with the ignition switched on.

#### Rear seat belts fastened display\*



Fig. 4 Instrument panel: left rear seat occupied and corresponding seat belt fastened display.

Depending on the model version, when the ignition is switched on, the seat belt status display >>> Fig. 4 on the instrument panel informs the driver whether the passengers in the rear seats have fastened their seat belts.

-  It indicates that the corresponding seat is empty.
-  Indicates that the seat is occupied and the occupant is wearing the seat belt.

The seat belt status flashes for a maximum of 30 seconds when a seat belt in the rear seats is unfastened while the vehicle is in motion. An audible warning will also be heard if the vehicle is travelling at over 25 km/h (15 mph).

If a seat belt is fastened or unfastened while driving in some of the rear seats, the seat belt status is displayed for approximately 30 >>>

seconds. The indication can be hidden by pressing the **(0.0/SET)** button on the dash panel.

### The protective function of seat belts



**Fig. 5** Drivers with properly worn seat belts will not be thrown forward in the event of sudden braking.

Properly worn seat belts hold the occupants in the proper position. They also help prevent uncontrolled movements that may result in serious injury and reduce the risk of being thrown out of the vehicle in case of an accident.

Vehicle occupants wearing their seat belts correctly benefit greatly from the ability of the belts to absorb kinetic energy. In addition, the front part of your vehicle and other passive safety features (such as the airbag system) are designed to absorb the kinetic

energy released in a collision. Taken together, all these features reduce the releasing kinetic energy and consequently, the risk of injury. This is why it is so important to fasten seat belts before every trip, even when "just driving around the corner".

Ensure that your passengers wear their seat belts as well. Accident statistics have shown that wearing seat belts is an effective means of substantially reducing the risk of injury and improving the chances of survival when involved in a serious accident. Furthermore, properly worn seat belts improve the protection provided by airbags in the event of an accident. For this reason, wearing a seat belt is required by law in most countries.

Although your vehicle is equipped with airbags, the seat belts must be fastened and worn. The front airbags, for example, are only triggered in some cases of head-on collision. The front airbags will not be triggered during minor frontal or side collisions, rear-end collisions, overturns or accidents in which the airbag trigger threshold value in the control unit is not exceeded.

### Important safety instructions for the use of seat belts

– Always wear the seat belt as described in this section.

– Ensure that the seat belts can be fastened at all times and are not damaged.

#### **⚠ WARNING**

- If seat belts are worn incorrectly or not at all, the risk of severe injuries increases. The optimal protection from seat belts can be achieved only if you use them properly.
- Never allow two passengers (even children) to share the same seat belt.
- Never unbuckle a seat belt while the vehicle is in motion. Risk of fatal injury.
- The seat belt should never lie on hard or fragile objects (such as glasses or pens, etc.) because this can cause injuries.
- Do not allow the seat belt to be damaged or jammed, or to rub on any sharp edges.
- Never wear the seat belt under the arm or in any other incorrect position.
- Bulky and unfastened clothing (such as an overcoat over a sweater) impairs the proper fit and function of the seat belts, reducing their capacity to protect.
- The slot in the seat belt buckle must not be blocked with paper or other objects, as this can prevent the latch plate from engaging securely.
- Never use seat belt clips, fastening rings or similar items to alter the position of the belt webbing.
- Frayed or torn seat belts or damage to the connections, belt retractors or parts of

the buckle could cause severe injuries in the event of an accident. Therefore, you must check the condition of all seat belts at regular intervals.

- Seat belts which have been worn in an accident and have been stretched must be replaced by a specialised workshop. Renewal may be necessary even if there is no apparent damage. The belt anchorage should also be checked.
- Do not attempt to repair a damaged seat belt yourself. The seat belts must not be removed or modified in any way.
- The belts must be kept clean, otherwise the retractors may not work properly.

### Head-on collisions and the laws of physics



**Fig. 6** A driver not wearing a seat belt is thrown forward violently.



**Fig. 7** The unbelted passenger in the rear seat is thrown forward violently, hitting the driver who is wearing a seat belt.

The effects of the laws of physics in the case of a head-on collision are easy to explain: the moment a vehicle starts moving, a type of energy called “kinetic energy” starts acting on both the vehicle and its passengers.

The amount of “kinetic energy” depends on the speed of the vehicle and on the weight of the vehicle and of its passengers. The higher they are, the more energy there is to be “absorbed” in the event of an accident.

The most significant factor, however, is the speed of the vehicle. If the speed doubles from 25 km/h (15 mph) to 50 km/h (30 mph), for example, the corresponding kinetic energy is multiplied by four.

Given that the passengers of the vehicle in our example do not have their seat belts fastened, in the event of a collision the entire

amount of the passengers' kinetic energy will be only absorbed by the mentioned impact.

Even at speeds of 30 km/h (19 mph) to 50 km/h (30 mph), the forces acting on bodies in a collision can easily exceed one tonne (1000 kg). At greater speed these forces are even higher.

Vehicle occupants not wearing seat belts are not “attached” to the vehicle. In a head-on collision, they will move forward at the same speed their vehicle was travelling just before the impact. This example applies not only to head-on collisions, but to all accidents and collisions.

Even at low speeds the forces acting on the body in a collision are so great that it is not possible to brace oneself with one's hands. In a frontal collision, unbelted passengers are thrown forward and will make violent contact with the steering wheel, dash panel, windscreen or whatever else is in the way >>> **Fig. 6**.

It is also important for rear passengers to wear seat belts properly, as they could otherwise be thrown forward violently through the vehicle interior in an accident. Passengers in the rear seats who do not use seat belts endanger not only themselves but also the front occupants >>> **Fig. 7**.

## How to properly adjust your seat belt

### Fastening and unfastening the seat belt

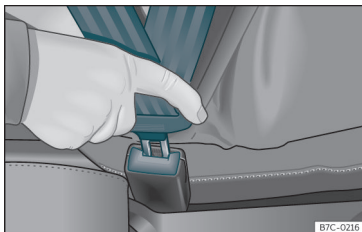

**Fig. 8** Insert the latch plate of the seat belt into the buckle.

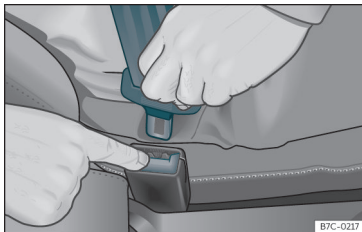



**Fig. 9** Release the seat belt's buckle.

Properly worn seat belts hold the vehicle occupants in the position that most protects them in the event of an accident or sudden braking >>> .

### Fastening the seat belt

Fasten your seat belt before each trip.

- Adjust the front seat and headrest correctly >>> page 12.
- Engage the seat backrest of the rear seat in an upright position >>> .
- Pull the latch plate and place the belt webbing evenly across your chest and lap. Do **not** twist the seat belt when doing so >>> .
- Engage the latch plate in the buckle of the corresponding seat >>> **Fig. 8**.
- Pull the belt to ensure that the latch plate is securely engaged in the buckle.

### Releasing the seat belt

Only unfasten the seat belt when the vehicle has come to a standstill >>> .

- Press the red button on the buckle >>> **Fig. 9**. The latch plate is released from the buckle.
- Guide the belt back by hand so that it rolls up easily and the trim will not be damaged.

### WARNING

- The seat belt cannot offer its full protection unless the seat backrest is in an upright position and the seat belt is worn correctly, according to your size.
- Unbuckling your seat belt while the vehicle is in motion can cause severe or fatal injuries in the event of an accident or sudden braking.
- The seat belt itself, or a loose seat belt, can cause severe injuries if the belt moves from hard areas of the body to soft areas (e.g. the stomach).

### Correct seat belt position

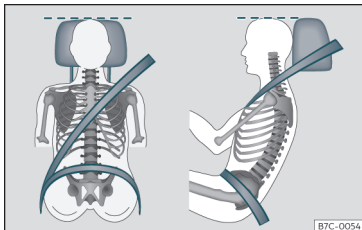

**Fig. 10** Correct seat belt and headrest positions, viewed from front and the side.

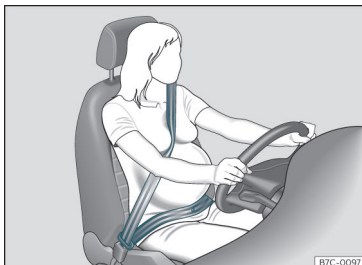

**Fig. 11** Position of seat belt during pregnancy.

Seat belts offer their maximum protection in the event of an accident and reduce the risk of sustaining severe or fatal injuries only when they are properly positioned. Furthermore, if the webbing is correctly positioned,

the seat belt will hold the vehicle occupants in the optimum position to ensure the airbag provides the maximum protection. The seat belt must therefore always be worn and the webbing correctly positioned.

Incorrectly worn seat belts can cause severe or even fatal injuries »» page 12, Correct sitting position of vehicle occupants.

- The shoulder part of the seat belt must lie on the centre of the shoulder, never across the neck or the arm, under the arm or behind the shoulder.
- The lap part of the seat belt must lie across the pelvis, never across the stomach.
- The seat belt must lie flat and fit comfortably. Pull the belt tight if necessary to take up any slack.

In the case of **pregnant women**, the seat belt must lie evenly across the chest and as low as possible over the pelvis, never across the stomach and must be worn properly at all times during the pregnancy »» **Fig. 11**.

### Adapting the position of the belt webbing to your size

The seat belt can be adapted using the following equipment:

- Belt height adjustment for the front seats.

### ⚠ WARNING

An incorrectly worn seat belt web can cause severe or fatal injuries in the event of an accident.

- The shoulder part of the seat belt must lie on the centre of the shoulder, never across the neck or the arm.
- The seat belt must lie flat and fit comfortably on the torso
- The lap part of the seat belt must lie across the pelvis, never across the stomach. The seat belt must lie flat and fit comfortably on the pelvis Pull the belt tight if necessary to take up any slack.
- For pregnant women, the lap part of the seat belt must lie as low as possible over the pelvis and always lie flat, “surrounding” the stomach»» **Fig. 11**.
- Do not twist the seat belt while it is fastened.
- Once the seat belt is positioned correctly, don't pull it away from your body with your hand.
- Do not lie the seat belt across rigid or fragile objects, e.g. glasses, pens or keys.
- Never use seat belt clips, retaining rings or similar instruments to alter the position of the belt webbing.

### **i** Note

If your physical constitution prevents you from maintaining the correct position of

»

the belt webbing, contact a specialised workshop for help with any special devices to ensure the optimum protection of the seat belt and airbag. CUPRA recommends taking your car in for technical service.

- The relevant safety requirements must be observed when the vehicle or components of the system are scrapped. Specialised workshops are familiar with these regulations, which are also available to you.

may fail to trigger or may trigger in the wrong circumstances.

- The seat belt tensioner, seat belt and automatic retractor cannot be repaired.
- Any work on the belt tensioners and seat belts, including the removal and refitting of system parts in conjunction with other repair work, must be performed by a specialised workshop only.
- The belt tensioners will only provide protection for one accident and must be changed if they have been activated.

## Seat belt tensioners

### How the seat belt tensioner works

The seat belts for the front seats and the side rear seats<sup>1)</sup> are equipped with belt tensioners.

The belt tensioners are activated by sensors, although only in severe head-on, lateral and rear-end collisions. This retracts and tightens the seat belts, reducing the forward motion of the occupants.

The belt pre-tensioners work in combination with the airbag system. In case of overturn, the pre-tensioners do not activate unless the head airbags are deployed.

#### Note

- If the seat belt tensioners are triggered, a fine dust is produced. This is normal and it is not an indication of fire in the vehicle.

### Maintenance and disposal of seat belt tensioners

The belt tensioners are components of the seat belts that are installed in the seats of your vehicle. If you work on the belt tensioners or remove and install parts of the system when performing other repair work, the seat belt may be damaged. The consequence may be that, in the event of an accident, the belt tensioners function incorrectly or may not function at all.

So that the effectiveness of the seat belt tensioner is not reduced and that removed parts do not cause any injuries or environmental pollution, regulations, which are known to the specialised workshops, must be observed.

#### WARNING

- Improper use or repairs not carried out by qualified mechanics increase the risk of severe or fatal injuries. The belt tensioners

#### For the sake of the environment

Airbag modules and belt tensioners may contain perchlorate. Observe the legal requirements for their disposal.

<sup>1)</sup> Depending on version/market.

## Airbag system

### Brief introduction

#### Why is it so important to wear a seat belt and to sit correctly?

For the inflating airbags to achieve the best protection, the seat belt must always be worn properly and the correct sitting position must be assumed.

The airbag system is not a substitute for seat belts, but it is an integral part of the vehicle's overall passive safety system. Please bear in mind that the airbag system can only work effectively when the vehicle occupants are wearing their seat belts correctly and have adjusted the headrests properly. Therefore, it is most important to properly wear the seat belts at all times, not only because this is required by law in most countries, but also for your safety »» page 15, The whys and wherefores of seat belts.

The airbag inflates in a matter of seconds, so if you are not properly seated when the airbag is triggered, you may sustain fatal injuries. Therefore, it is essential that all vehicle occupants assume a correct sitting position while travelling.

Sharp braking before an accident may cause a passenger not wearing a seat belt to be

thrown forward into the area of the deploying airbag. In this case, the inflating airbag may inflict critical or fatal injuries on the occupant. This also applies to children.

Always maintain the greatest possible distance between yourself and the front airbag. This way, the front airbags can completely deploy when triggered, providing their maximum protection.

The most important factors for triggering the airbag are the type of accident, the angle of impact and the vehicle speed.

Whether or not the airbags are triggered depends primarily on the vehicle deceleration rate resulting from the collision and detected by the control unit. If the vehicle deceleration occurring during the collision and measured by the control unit remains below the specified reference values, the front, side and/or head-protection airbags will not be triggered. Take into account that the visible damage in a vehicle involved in an accident, no matter how serious, is not a determining factor for the airbags to have been triggered.

#### WARNING

- Wearing the seat belt incorrectly or assuming an incorrect sitting position can lead to critical or fatal injuries.
- All vehicle occupants, including children, who are not properly belted can sustain critical or fatal injuries if the airbag is trig-

gered. Children up to 12 years old should always travel on the rear seat. Never transport children in the vehicle if they are not restrained or the restraint system is not appropriate for their age, size or weight.

- To reduce the risk of injury from an inflating airbag, always wear the seat belt properly »» page 15.

### Description of the airbag system

The airbag system offers additional protection for the occupants in combination with the seat belts.

**The airbag system comprises the following modules (as per vehicle equipment):**

- Electronic control unit
- Front airbags for driver and passenger
- Knee airbag for the driver
- Side airbags
- Head airbag
- Airbag control lamp  on the instrument panel »» page 23
- Key-operated switch for front passenger airbag
- Control lamp for disabled/enabled status of the front passenger airbag.

»

The airbag system operation is monitored electronically. The airbag control lamp will illuminate for a few seconds every time the ignition is switched on (self-diagnosis).

#### There is a fault in the system if the control lamp :

- does not light up when the ignition is switched on >>> page 23,
- turns off after 4 seconds after the ignition is switched on,
- turns off and then lights up again after the ignition is switched on,
- illuminates or flashes while the vehicle is moving.

#### The airbag system is not triggered if:

- the ignition is switched off
- there is a minor frontal collision
- there is a minor side collision
- there is a rear-end collision
- the vehicle turns over.

#### WARNING

- **The seat belts and airbags can only provide maximum protection if the occupants are seated correctly >>> page 12.**
- **If a fault has occurred in the airbag system, have the system checked immediately by a specialised workshop. Otherwise there is a danger that during a collision, the sys-**

**tem may fail to trigger, or not trigger correctly.**

#### Airbag activation

The airbags deploy extremely rapidly, within thousands of a second, to provide additional protection in the event of an accident. A fine dust may develop when the airbag deploys. This is normal and it is not an indication of fire in the vehicle.

The airbag system is only ready to function when the ignition is on.

In special accidents instances, several airbags may activate at the same time.

In the event of minor head-on and side collisions, rear-end collisions, overturning or roll-over of the vehicle, airbags **do not activate**.

#### Activation factors

The conditions that lead to the airbag system activating in each situation cannot be generalised. Some factors play an important role, such as the properties of the object the vehicle hits (hard/soft), angle of impact, vehicle speed, etc.

Deceleration trajectory is key for airbag activation.

The control unit analyses the collision trajectory and activates the respective restraint system.

If the deceleration rate is below the predefined reference value in the control unit the airbags will not be triggered, even though the accident may cause extensive damage to the car.

#### The following airbags are triggered in serious head-on collisions:

- Driver airbag.
- Front passenger front airbag
- Knee airbag for the driver.

#### The following airbags are triggered in serious side-on collisions:

- Front side airbag on the side of the accident.
- Curtain (head) airbag on the side of the accident.

#### In an accident with airbag activation:

- the interior lights switch on (if the interior light switch is in the courtesy light position);
- the hazard warning lights switch on;
- all doors are unlocked;
- the fuel supply to the engine is cut.



## Operation of the airbags

### Airbag system control lamps



#### It lights up on the combi-instrument

Fault in the airbag system and seat belt tensioners .  
Have the system checked immediately by a specialised workshop.



#### OFF It lights up on the dash panel

Fault in the airbag system.  
Have the system checked immediately by a specialised workshop.



Front passenger front airbag deactivated.  
Check if the airbag should be kept deactivated







#### ON It lights up on the dash panel

Front passenger front airbag activated.  
The control lamp turns off automatically 60 seconds after the ignition is switched on

Several warning and control lamps light up for a few seconds when the ignition is switched on, signalling that the function is being verified. They will switch off after a few seconds.

If the airbag and seat belt tensioner system control lamp  remains on or flashes, it indicates a malfunction in the airbag and seat belt tensioner system >>> . Have the system

checked immediately by a specialised workshop.

If the front passenger airbag is deactivated, the warning lamp **PASSENGER AIR BAG OFF** ; remains lit on the dash panel to remind you that the airbag is deactivated. If, with the front passenger airbag deactivated, this lamp **does not remain lit** or if it is lit along with the control lamp  on the instrument panel, there is a fault in the airbag system >>> . If the control lamp is flashing, there is a fault in the disabling of the airbag system >>> . Have the system checked immediately by a specialised workshop.

### WARNING

In the event of a fault in the airbag and seat belt tensioner system, the airbags and seat belts may not trigger correctly, may fail to trigger or may even trigger unexpectedly.

- The vehicle occupants run the risk of sustaining severe or fatal injuries. Have the system checked immediately by a specialised workshop.
- Do not mount a child seat in the front passenger seat or remove the mounted child seat! The front passenger front airbag may deploy during an accident in spite of the fault.

### CAUTION

Always pay attention to any lit control lamps and to the corresponding descrip-

tions and instructions to avoid damage to the vehicle or harm to the occupants.

## Front airbags

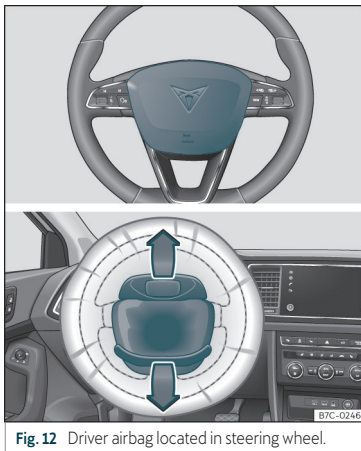

Fig. 12 Driver airbag located in steering wheel.



Fig. 13 Front passenger airbag located in dash panel.

The front airbag for the driver is located in the steering wheel >>> Fig. 12 and the airbag for the front passenger is located in the dash panel >>> Fig. 13. Airbags are identified by the word “AIRBAG”.

When the driver and front passenger airbags are deployed, the covers remain attached to the steering wheel and dashboard, respectively >>> Fig. 12 >>> Fig. 13.

In conjunction with the seat belts, the front airbag system gives the front occupants ad-

ditional protection for the head and chest in the event of a severe frontal collision >>> ⚠.

Their special design allows the controlled escape of the propellant gas when an occupant puts pressure on the bag. Thus, the head and chest are protected by the airbag. After the collision, the airbag deflates sufficiently to allow visibility.

⚠ WARNING

- The deployment space between the front passengers and the airbags must not in any case be occupied by other passenger, pets and objects.
- The airbags provide protection for just one accident; replace them once they have deployed.
- It is also important not to attach any objects such as cup holders or telephone mountings to the surfaces covering the airbag units.

### Activate and deactivate front passenger front airbag\*



Fig. 14 Switch for activating and deactivating the front passenger airbag.







Fig. 15 Dash panel: control lamp for the deactivation of the front passenger front airbag.

Deactivate the front passenger front airbag only if you have to use a rear-facing child seat in the front passenger seat.

CUPRA recommends fitting the child seat in the rear seat to avoid having to deactivate the front passenger airbag.

When the front passenger airbag is **deactivated**, this means that only the front passenger front airbag is deactivated. All the other airbags in the vehicle remain activated.

### Deactivate and activate the front passenger front airbag

- Switch the ignition off.
- Open the door on the front passenger side.
- Insert the key into the slot of the switch for deactivating the front passenger airbag >>> Fig. 14. About 3/4 of the key should enter; this is as far as it will go.
- Turn the key gently to change its position to **OFF** (deactivate) or to **ON** (activate). If you have difficulty, ensure that you have inserted the key as far as it will go.
- Close the front passenger door.
- When deactivating the airbag, switch the ignition on and check that the control lamp **OFF**  remains lit where it says **PASSENGER AIR BAG OFF**  in the central part of the dashboard >>> Fig. 15.
- When reactivating the airbag, check that when the ignition is switched on, the **OFF**  control lamp does not light up and the **ON** .

lamp lights up or 60 seconds and then turns off.

### ⚠ WARNING

- The driver of the vehicle is responsible for disabling or switching on the airbag.
- Always switch off the ignition before disabling the front passenger airbag! Failure to do so could result in a fault in the airbag deactivation system.
- Never leave the key in the airbag disabling switch as it could get damaged or enable or disable the airbag during driving.
- If for any reason an airbag is deactivated, reactivate it as soon as possible so that it can fulfil its protective function.

## Knee airbag\*



**Fig. 16** On the driver side: location of the knee airbag



**Fig. 17** On the driver side: airbag action radius for the knees.

The knee airbag is located on the driver side below the dash panel >>> **Fig. 16**. Airbags are identified by the word “AIRBAG”.

The area framed in red (deployment area) >>> **Fig. 17** is covered by the knee airbag when

it is deployed. Objects should never be placed or mounted in this area.

### **⚠ WARNING**

- The knee airbag is deployed in front of the driver's knees. Always keep the deployment areas of the knee airbags free.
- Never not fix objects to the cover or in the deployment area of the knee airbag.
- Adjust the driver's seat so that there is a distance of at least 10 cm (4 inches) between your knees and the location of the this airbag. If your physical constitution prevents you from meeting these requirements, make sure you contact a specialised workshop.

## Side airbags\*

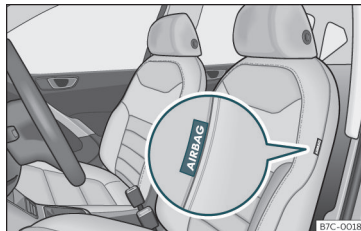

**Fig. 18** Side airbag in driver's seat.

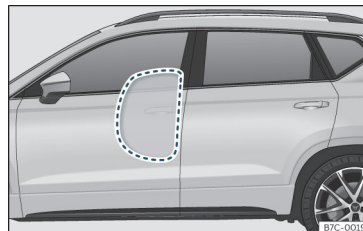

**Fig. 19** Illustration of completely inflated side airbags on the left side of the vehicle.

The side airbags are located in the driver's seat and front passenger seat backrests >>> **Fig. 18**.

The locations are identified by the text “AIRBAG” in the upper region of the backrests.

In conjunction with the seat belts, the side airbag system provides additional protection for the upper body in the event of a severe side collision >>> **△**.

In a side collision, the side airbags reduce the risk of injury to passengers to the areas of the body facing the impact. In addition to their normal protection, the seat belts also hold the passengers in the event of a side collision; this is how these airbags provide maximum protection.

**⚠ WARNING**

- If you do not wear a seat belt, if you lean forward, or are not seated correctly while the vehicle is in motion, you are at a greater risk of injury if the side airbag system is triggered in an accident.
- In order for the side airbags to provide their maximum protection, the prescribed sitting position must always be maintained with seat belts fastened while travelling.
- In a side-on collision the side airbags will not work if the sensors do not correctly measure the pressure increase on the interior of the doors, due to air escaping through the areas with holes or openings in the door panel.
- Never drive if the interior door panels have been removed or if the panels have not been correctly fitted.
- Never drive the vehicle if the loudspeakers in the door panels have been removed, unless the holes left by the loudspeakers have been closed properly.
- Always check that the openings are closed or covered if loudspeakers or other equipment are fitted inside the door panels.
- Occupants of the outer seats must never carry any objects or pets in the deployment space between them and the airbags, or allow children or other passengers to travel in this position. It is also important not to attach any accessories (such as cup holders)

to the doors. This would impair the protection offered by the side airbags.

- The built-in coat hooks should be used only for lightweight clothing. Do not leave any heavy or sharp-edged objects in the pockets.
- Great forces, such as hard blows or kicks, must not be exerted upon the backrest bolster because the system may be damaged. In this case, the side airbags would not be triggered.
- Under no circumstances should protective covers be fitted over seats with side airbags unless the covers have been approved for use in your vehicle. Because the airbag deploys from the side of the backrest, the use of conventional seat covers would obstruct the side airbag, seriously reducing the airbag's effectiveness.
- Any damage to the original seat upholstery or around the seams of the side airbag units must be repaired immediately by a specialised workshop.
- The airbags provide protection for just one accident; replace them once they have deployed.
- Any work on the side airbag system or removal and installation of the airbag components for other repairs (such as removal of the front seat) should only be performed by a specialised workshop. Otherwise, faults may occur during the airbag system operation.

**head-protection airbags\***

**Fig. 20** Location of head-protection airbags.

The head-protection airbags are located on both sides in the interior above the doors >>> **Fig. 20** and are identified with the text "AIRBAG".

In conjunction with the seat belts, the head-protection airbag system gives the vehicle occupants additional protection for the head and upper body in the event of a severe side collision >>> **⚠**.

The area framed in red is covered by the head-protection airbag when it is deployed >>> **Fig. 20** (deployment area). Therefore, objects should never be placed or mounted in this area >>> **⚠**.

In the event of a side collision the head-protection airbag is triggered on the impact side of the vehicle. >>>

The head-protection airbags reduce the risk of injury to passengers in the front and rear side seats facing the impact.

### WARNING

- In order for the head-protection airbags to provide their maximum protection, the prescribed sitting position must always be maintained with seat belts fastened while travelling.
- For safety reasons, the head-protection airbag must be disabled in those vehicles fitted with a screen dividing the interior of the vehicle. See your technical service to make this adjustment.
- There must be no other persons, animals or objects between the occupants of the outer seats and the deployment space of the head-protection airbags so that the head-protection airbag can deploy completely without restriction and provide the greatest possible protection. Therefore, sun blinds which have not been expressly approved for use in your vehicle may not be attached to the side windows
- The built-in coat hooks should be used only for lightweight clothing. Do not leave any heavy or sharp-edged objects in the pockets. Please, do not hang the clothes on coat hangers.
- The airbags provide protection for just one accident; replace them once they have deployed.

- Any work on the head-protection airbag system or removal and installation of the airbag components for other repairs (such as removal of the roof lining) should only be performed by a specialised workshop. Otherwise, faults may occur during the airbag system operation.

- The side and head airbags are managed through sensors located in the interior of the front doors. To ensure the correct operation of the side and head-protection airbags neither the doors nor the door panels should be modified in any way (e.g. fitting loudspeakers). If the front door is damaged, the airbag system may not work correctly. All work carried out on the front door must be done in a specialised workshop.

## Transporting children safely

### Safety for children

#### Introduction

For safety reasons, as we have learned from accident statistics, we recommend that children under 12 years of age travel in the rear seats. Depending on their age, height and weight, children travelling in rear seats must use a child seat or a seat belt. For safety reasons, the child seat should be installed in the rear seat, behind the front passenger seat or in the centre back seat.

The physical laws involved and the forces acting in a collision apply also to children >>> page 17. But unlike adults, children do not have fully developed muscle and bone structures. This means that children are subject to a greater risk of injury.

To reduce the risk of injuries, children must always use special child restraint systems when travelling in the vehicle.

We recommend the use of child safety products from the Original Accessories Programme, which includes systems for all ages made by "Peke" (not for all countries) (see [www.seat.com](http://www.seat.com)).

These systems have been especially designed and approved, complying with the ECE-R44. regulation.

CUPRA recommends securing the child seats shown on the website as described below:

- Child seats in the opposite direction of travel (group 0+): ISOFIX and support bracket (Peke GO Plus + ISOFIX Base (RWF)).
- Child seats in the direction of travel (group 1): ISOFIX and Top Tether (Peke G1 ISOFIX DUO Plus).
- Child seats directed towards the front of the vehicle for group 2: safety belt and ISOFIX (Peke G3 KIDFIX)<sup>1)</sup>.
- Child seats directed towards the front of the vehicle for group 3: safety belt and ISOFIX (Peke G3 KIDFIX)<sup>1)</sup>.

Follow the manufacturer's instructions and observe any statutory requirements when installing and using child seats. Always read and note >>> page 30.

We recommend you always carry the manufacturer's Child Seat Instruction Manual together with the on-board documentation.

<sup>1)</sup> Temporarily, the child seat recommended by the Accessories Programme for groups 2 and 3 will be ROMER KIDFIX XP<sup>®</sup> instead of Peke G3 KIDFIX. It is available from the CUPRA website.

### Child seats group classification



Fig. 21 Examples of child seats.

Use only child seats that are officially approved and suitable for the child.

Child seats are subject to the regulation ECE-R 44 or ECE-R 129. ECE-R stands for: Economic Commission for Europe Regulation.

### Child seats by weight group

The child seats are grouped into 5 categories:

Age group	Weight of the child
Group 0	Up to 10 kg
Group 0+	Up to 13 kg
Group 1	From 9 to 18 kg
Group 2	From 15 to 25 kg
Group 3	From 22 to 36 kg

Child seats that have been tested and approved under the ECE-R 44 or ECE-R 129 standard bear the test mark ECE-R 44 or ECE-R 129 on the seat (the letter E in a circle with the test number below it).

Follow the manufacturer's instructions and observe any statutory requirements when installing and using child seats.

We recommend you to always include the manufacturer's Child Seat Instruction Manual together with the on-board documentation.

CUPRA recommends you use child seats from the **Original Accessories Catalogue**. These child seats have been designed and tested for use in our vehicles. You can find the right child seat for your model and age group at our dealers. »

### Child seats by approval category

Child seats may have the approval category of universal, semi-universal, vehicle specific (all according to the ECE-R 44 standard) or i-Size (according to the ECE-R 129 standard).

- **Universal:** child seats with universal approval can be installed in all vehicles. There is no need to consult any list of models. In the case of universal approval for ISOFIX, the child seat is additionally provided with a Top Tether belt.
- **Semi-universal:** semi-universal approval, in addition to the standard requirements of universal approval, requires safety devices to lock the child seat, which require additional testing. Child seats with semi-universal approval include a list of vehicle models for which they can be installed.
- **Vehicle-specific:** vehicle-specific approval requires a dynamic test of the child seat for each vehicle model separately. Child seats with vehicle-specific approval also include a list of vehicle models for which they can be installed.
- **i-Size:** child seats with i-Size approval must meet the requirements prescribed in the ECE-R 129 standard in relation to installation and safety. Child seat manufacturers can tell you which seats have i-Size approval for this vehicle.

### Fitting and using child seats



Fig. 22 Airbag sticker: on the passenger's sun visor

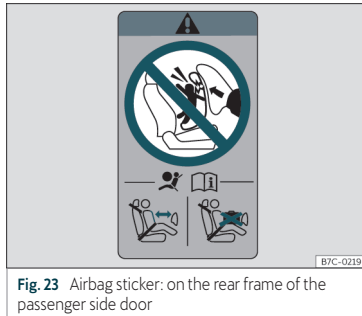

Fig. 23 Airbag sticker: on the rear frame of the passenger side door

#### Warnings about fitting a child seat

Take the following general warnings into account if you are going to fit a child seat. They are valid for all child seats regardless of their attachment system.

- Please read and follow the child seat manufacturer's operating instructions.
- The child seat should preferably be fitted to the rear seat behind the front passenger seat so that the child can exit the vehicle on the pavement side.
- Set the height of the seat belt such that it adapts to the child seat naturally, without twisting. The lowest position of the seat belt height regulator must be used with rear-facing child seats.
- To correctly use a child seat in the back, the front backrest must be adjusted so that there is no contact with the child seat in the back in the case that it goes opposite to the direction of the car. In the case of front facing restraint systems, the front backrest must be adjusted so that there is no contact with the child's feet.
- If a semi-universal type chair is to be installed, in which the method of attachment to the car is through the seat belt and support bracket, it should never be installed in the central rear seat as the ground clearance is lower than in other places and the support bracket will not allow the seat to remain sufficiently stable.
- When fitting a child seat on the front passenger seat, the seat must be moved backwards as far as possible and placed in the



highest position. The backrest must also be put in a vertical position<sup>1)</sup>.

### Important information about the front passenger front airbag

A sticker with important information about the passenger airbag is located on the passenger's sun visor and/or on the passenger side door frame »» Fig. 22.

Read and always observe the safety information included in the following chapters:

- Safety distance with respect to the passenger airbag »» page 21.
- Objects between the passenger and the passenger side airbag »» ⚠ in Front airbags on page 24.

The passenger side front airbag, when enabled, is a serious risk for a child that is facing backward since the airbag can strike the seat with such force that it can cause serious or fatal injuries. Children up to 12 years old should always travel on the rear seat.

Therefore we strongly recommend you to transport children on the rear seats. This is the safest location in the vehicle. Alternatively, the front passenger airbag can be dis-

abled with a key-operated switch »» page 25. When transporting children, use a child seat suitable for the age and size of each child »» page 29.

#### WARNING

- If a child seat is secured to the front passenger seat, the risk to the child of sustaining critical or fatal injuries in the event of an accident increases.
- An inflating front passenger airbag can strike the rear-facing child seat and project it with great force against the door, the roof or the backrest.
- Never install a child seat facing backwards on the front passenger seat unless the front passenger front airbag has been disabled. Risk of potentially fatal injuries to the child! However, if necessary, the front passenger front airbag must be deactivated »» page 25. If the passenger seat has a height adjustment option, move it to the highest, most upright position. If you have a fixed seat, do not install any child restraint system in this location.
- For those vehicles that do not include a key lock switch to deactivate the airbag, the vehicle must be taken to a technical service. Do not forget to reconnect the airbag

when an adult wants to sit in the front passenger seat.

- Never allow a child to be transported in a vehicle without being properly secured, or to stand up or kneel on a seat while travelling. In an accident, the child could be flung through the vehicle, causing possibly fatal injuries to themselves and to the other vehicle occupants.
- Never leave a child alone in the child seat or in the vehicle.
- Children who are less than 1.5 metres tall must not wear a normal seat belt without a child seat, as this could cause injuries to the abdominal and neck areas during a sudden braking manoeuvre or in an accident.
- When a child seat is mounted in the rear seats, the door child-proof lock should be activated »» page 97.

### Attachment systems

Depending on the country, different attachment systems are used for safely installing child seats. »»

<sup>1)</sup> Compliance with current national legislation and the manufacturer's instructions is required when using or installing child seats.

### Attachment systems overview

- **ISOFIX:** ISOFIX is a standardised attachment system allowing quick and safe attachment of child seats in the vehicle. ISOFIX attachment establishes a rigid connection between the child seat and the car body.

The child seat has two rigid attachment clips, called connectors. These connectors are fitted into the ISOFIX attachment rings found between the seat cushion and the backrest of the vehicle's back seat (on the sides). ISOFIX attachment systems are used mainly in Europe »» page 33. If necessary, ISOFIX attachment may have to be supplemented with a Top Tether belt or a support bracket.

- **Automatic three-point seat belt.** Whenever possible, it is preferable to attach the child seats with the ISOFIX system rather than attaching them with an automatic three-point seat belt »» page 36.

Additional attachment:

- **Top Tether:** the Top Tether belt is guided over the back of the rear seat and attached to an anchor point with a hook. Anchor points are located at the back of the rear seat backrest on the boot side »» page 35. The rings for retaining the Top Tether belt are marked with an anchor symbol.

- **Support bracket:** some child seats rest on the floor of the vehicle with a support bracket. The support bracket prevents the child seat from tipping forward in the event of impact. Child seats fitted with a support bracket should only be used in the passenger seat and side rear seats »» ⚠. For the assembly of this type of seat you should also consult the list of approved vehicles for this assembly, available in the instructions for child restraint systems.

### Recommended systems for attaching child seats

CUPRA recommends attaching child seats as follows:

- **Baby carriers or child seats in the opposite direction of travel:** ISOFIX and support bracket or i-Size.
- **Child seats in the direction of travel:** ISOFIX and Top Tether.

#### WARNING

Incorrect use of the support bracket can cause serious or fatal injury.

- **Make sure the support bracket is correctly and safely installed.**

## Fit a child seat with the ISOFIX / i-Size and Top Tether\* system



**Fig. 24** Rear seat: ISOFIX/i-Size securing rings.

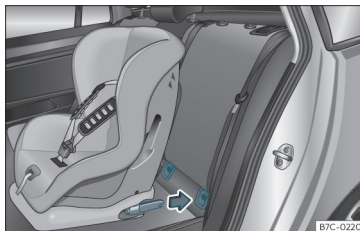

**Fig. 25** Rear seats: fitting a child seat with the ISOFIX system.

Child seats can be secured quickly, easily and safely on the rear side seats with the “ISOFIX” and Top Tether\* system.

Two “ISOFIX” retaining rings are fitted on each rear side seat. In some vehicles, the

rings are secured to the seat frame and, in others, they are secured to the rear floor. The “ISOFIX” rings are located between the rear seat backrest and the seat cushioning >>> **Fig. 24**. The Top Tether\* rings are located on the rear part of the backrests of the rear

seats (behind the seat backrest or in the boot) >>> page 35.

To understand the compatibility of the “ISOFIX” systems in the vehicle, check the table below.

Weight group	Size class <sup>a)</sup>	Electrical equipment	Vehicle Isofix positions			
			Front passenger seat		Rear side seat	Rear central seat
			airbag on	airbag off		
Baby carrier	F	ISO/L1	X	X	X	X
	G	ISO/L2	X	X	X	X

IUF: Suitable for forward-facing ISOFIX universal child restraint systems approved for use in this weight group.

IL: It is suitable for certain ISOFIX child restraint systems (CRS) that can be for the specific vehicle, restricted or semi-universal categories. Take the child seat manufacturer's vehicle list into account.

X: ISOFIX position not suitable for ISOFIX child restraint systems for this weight group or size class.



## Safety

Weight group	Size class <sup>a)</sup>	Electrical equipment	Vehicle Isofix positions			
			Front passenger seat		Rear side seat	Rear central seat
			airbag on	airbag off		
Group 0 to 10 kg	E	ISO/R1	X	X	IL	X
Group 0+ to 13 kg	E	ISO/R1	X	X	IL	X
	D	ISO/R2	X	X	IL	X
	C	ISO/R3	X	X	IL	X
Group I 9 to 18 kg	D	ISO/R2	X	X	IL	X
	C	ISO/R3	X	X	IL	X
	B	ISO/F2	X	X	IUF/IL	X
	B1	ISO/F2X	X	X	IUF/IL	X
	A	ISO/F3	X	X	IUF/IL	X
Group II 15 to 25 kg	---	---	X	X	---	X
Group III 22 to 36 kg	---	---	X	X	---	X

IUF: Suitable for forward-facing ISOFIX universal child restraint systems approved for use in this weight group.

IL: It is suitable for certain ISOFIX child restraint systems (CRS) that can be for the specific vehicle, restricted or semi-universal categories. Take the child seat manufacturer's vehicle list into account.

X: ISOFIX position not suitable for ISOFIX child restraint systems for this weight group or size class.

<sup>a)</sup> The indication of class according to size corresponds to the authorised bodyweight for the child seat. In child seats with universal or semi-universal approval, the class according to size is indicated on the ECE approval label. The indication of class according to size is stated on the corresponding child seat.

## Transporting children safely

	Vehicle i-Size positions			
	Front passenger seat		Rear side seat	Rear central seat
	airbag on	airbag off		
i-Size child seats	X	X	i-U	X

i-U: Position suitable for front-facing and rear-facing child restraint systems approved under ECE R129.

X: Invalid position for child restraint systems approved under ECE R129.

### Securing the child seat with the “ISOFIX/i-Size” system

You are obliged to follow the seat manufacturer's instructions.

- Press the child seat onto the “ISO-FIX/iSize” retaining rings until the child seat is heard to engage securely >>> Fig. 25. If the child seat is equipped with Top Tether\* anchor points, secure it to the correspondent ring >>> page 35. Observe the manufacturer's instructions.

- Pull on both sides of the child seat to ensure that it is properly anchored.

Child seats with the “ISOFIX” and Top Tether\* attachment system are available from Technical Services.

#### WARNING

The retaining rings are designed only for use with “ISOFIX” and Top Tether\* system child seats.

- Never secure other child seats that do not have the “ISOFIX” or Top Tether\* system, or retaining belts or objects to the fastening rings - this can result in potentially fatal injuries to the child.
- Ensure that the child seat is secured correctly using the “ISOFIX” and Top Tether\* securing rings.

### Top Tether\* securing belts

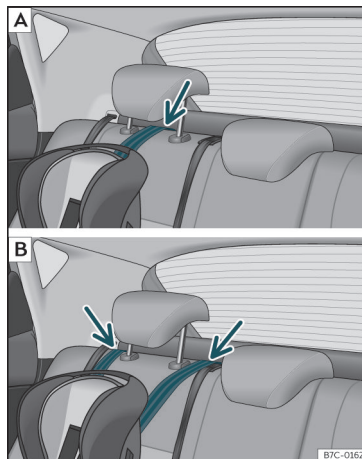
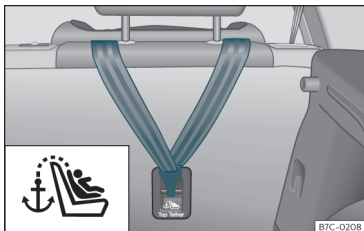

Fig. 26 Rear seats: adjustment and assembly according to the Top Tether belt.

»



**Fig. 27** Back of the rear seats: Top Tether securing rings.

Child seats with the Top Tether system come with a strap for securing the seat to the vehicle anchor point, located at the back of the rear seat backrest and provide greater restraint.

The objective of this strap is to reduce forward movements of the child seat in a crash, to reduce the risk of injuries to the head from hitting the inside of the vehicle.

### Fitting a child seat using the seat belt

If you want to fit a universal approval category (U) child seat in your vehicle, you must check that the seat is approved for your ve-

### Using the Top Tether in rear-facing mounted seats

Currently, there are very few rear-facing child safety seats that have Top Tether. Please carefully read and follow the seat manufacturer instructions to learn the proper way to install the Top Tether strap.

### Securing the retainer strap

- Follow the manufacturer's instructions to deploy the child seat Top Tether retaining strap.
- Place the belt under the headrest of the back seat >>> **Fig. 26** (depending on the instructions of the chair itself, lift or remove the headrest if necessary).
- Slide the strap and secure it properly with the anchorage of the backrest >>> **Fig. 27**.
- Firmly tighten the strap following the manufacturer's instructions.

hicle. You will find any necessary information on the child seat's orange ECE approval la-

### Releasing the retaining strap

- Loosen the strap following the manufacturer's instructions.
- Push the lock and release it from the anchoring support.

### **⚠ WARNING**

An undue installation of the safety seat will increase the risk of injury in the event of a crash.

- Never tie the retainer strap to a hook in the luggage compartment.
- Never secure or tie luggage or other items to the lower anchorages (ISOFIX) or the upper ones (Top Tether).

bel. The following table shows the different fitting options.

## Transporting children safely

Weight group	Seating position			
	Front passenger seat <sup>a)</sup>		Rear side seat	Rear central seat <sup>b)</sup>
	Airbag activated	airbag disabled <sup>c)</sup>		
Group 0 to 10 kg	X	U	U	U
Group 0+ to 13 kg	X	U	U	U
Group I 9 to 18 kg	X	U	U	U
Group II 15 to 25 kg	X	UF	UF	UF
Group III 22 to 36 kg	X	UF	UF	UF

X: Not compatible for the installation of seats install chairs in this configuration.

U: Suitable for universal restraint systems for use in this weight group.

UF: Acceptable for front-facing universal-category child restraint systems approved for this mass group.

- <sup>a)</sup> Compliance with current national legislation and the manufacturer's instructions is required when using or installing child seats.
- <sup>b)</sup> For semi-universal chairs where the securing system is the car safety belt and the support bracket, do not use them in the centre rear seat.
- <sup>c)</sup> Seats **without** height adjustment should be placed in their rearmost position. Seats **with** height adjustment should be placed in their rearmost and highest position.

### Fitting a child seat using the seat belt

- Set the height of the seat belt such that it adapts to the child seat naturally, without twisting. The lowest position of the seat belt height regulator must be used with rear-facing child seats.
- Put the seat belt in place and pass it through the child seat according to the instructions of the child seat manufacturer.
- Make sure that the seat belt is not twisted.
- Insert the latch plate into the seat's buckle until you hear the engagement click.

#### WARNING

When travelling, children must be secured in the vehicle with a restraint system suitable for age, weight and size.

- Read and always observe information and warnings concerning the use of child seats  
»» page 30.

## Emergencies

### Self-help

### Emergency equipment

#### Vehicle tool kit

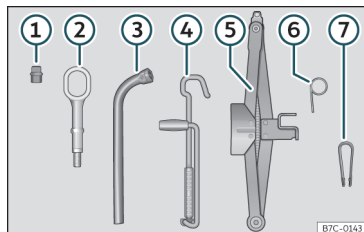

**Fig. 28** Underneath the floor panel of the luggage compartment: vehicle tool kit.

The vehicle tool kit is located under the floor panel in the luggage compartment. To access the vehicle tools >>> page 126.

The tool kit includes:

- ① Adapter for the anti-theft bolt\*
- ② Towing eye, removable
- ③ Wheel spanner\*
- ④ Crank handle for jack

- ⑤ Jack\*
- ⑥ Hook for extracting the central wheel trims\*
- ⑦ Clip for removing the wheel bolt caps

Some of the items listed are only provided in certain model versions, or are optional extras.

#### ⚠ WARNING

When the vehicle tool kit, tyre mobility set and spare wheel are loose in the interior they can be violently thrown in case of a sudden manoeuvre or braking and especially in accidents, causing serious injury.

- Ensure that the vehicle tool kit, the tyre mobility set and the spare wheel or temporary spare wheel are safely secured in the luggage compartment.

#### ⚠ WARNING

Unsuitable or damaged vehicle tools can cause injury or accidents.

- Never work with inappropriate or damaged tools.

#### **i** Note

The jack does not generally require any maintenance. If required, it should be greased using universal type grease.

## Tyre repairs

### TMS (Tyre Mobility System)\*

The Anti-puncture kit\* (Tyre Mobility System) will reliably seal punctures caused by the penetration of a foreign body of up to about 4 mm in diameter. **Do not remove foreign objects, e.g. screws or nails, from the tyre.**

After inserting the sealant residue in the tyre, you must again check the tyre pressure about 10 minutes after starting the engine.

You should only use the tyre mobility set if the vehicle is parked in a safe place, you are familiar with the procedure and you have the necessary tyre mobility set! Otherwise, you should seek professional assistance.

**Do not use the tyre sealant in the following cases:**

- If the wheel rim has been damaged.
- In outside temperatures below -20°C (-4°F).
- In the event of cuts or perforations in the tyre greater than 4 mm.
- If you have been driving with very low pressure or a completely flat tyre.
- If the sealant bottle has passed its use by date.



**⚠ WARNING**

Using the tyre mobility system can be dangerous, especially when filling the tyre at the roadside. Please observe the following rules to minimise the risk of injury:

- Stop the vehicle safely as soon as possible. Park it at a safe distance from surrounding traffic to fill the tyre.
- Ensure the ground on which you park is flat and solid.
- All passengers and particularly children must keep a safe distance from the work area.
- Turn on the hazard warning lights to warn other road users.
- Use the tyre mobility system only if you are familiar with the necessary procedures. Otherwise, you should seek professional assistance.
- The tyre mobility set is intended for temporary emergency use only until you can reach the nearest specialised workshop.
- Replace the repaired tyre with the tyre mobility set as soon as possible.
- The sealant is a health hazard and must be cleaned immediately if it comes into contact with the skin.
- Always keep the tyre mobility set out of the reach of small children.
- Always switch off the engine, activate the electronic parking brake and place the se-

lector lever in P to reduce the risk of accidental vehicle movement.

**⚠ WARNING**

A tyre filled with sealant does not have the same performance properties as a conventional tyre.

- Never drive faster than 80 km/h (50 mph).
- Avoid heavy acceleration, hard braking and fast cornering.
- Drive for only 10 minutes at a maximum speed of 80 km/h (50 mph) and then check the tyre.

**♻ For the sake of the environment**

Dispose of used or expired sealant observing any legal requirements.

**i Note**

You can purchase a new bottle of tyre sealant in specialised CUPRA dealers or any SEAT dealership.

**i Note**

Take into account the separate instruction manual of the tyre mobility set\* manufacturer.

**Anti-puncture kit contents\***

Fig. 29 Standard representation: anti-puncture kit contents.

The anti-puncture kit is located underneath the floor covering in the luggage compartment. It includes the following components >>> Fig. 29:

- ① Valve insert remover
- ② A sticker to be adhered to the instrument cluster, within the driver's visual field, to remind that the maximum advisable speed "max. 80 km/h" or "max. 50 mph"
- ③ Filler tube with cap
- ④ Air compressor
- ⑤ ON/OFF switch
- ⑥ Air bleed screw (it can also be integrated in the inflator tube).

»

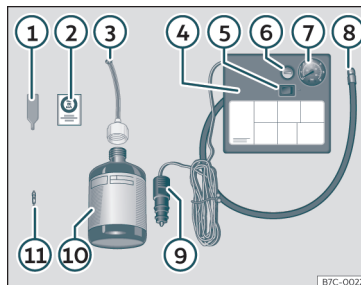
- ⑦ Warning provided by tyre pressure monitoring system (it can also be integrated in the inflator tube).
- ⑧ Tube for inflating tyres
- ⑨ 12 volt connector
- ⑩ Bottle of sealant
- ⑪ Spare tyre valve

The **valve insert remover** ① has a gap at the lower end for a valve insert. The valve insert can only be screwed or unscrewed in this way. This also applies to its replacement part ⑪.

### Sealing and inflating a tyre

#### Sealing the tyre

- Unscrew the tyre valve cap and insert. Use the >>> **Fig. 29** ① tool to remove the insert. Place it on a clean surface.
- Shake the tyre sealant bottle vigorously >>> **Fig. 29** ⑩.
- Screw the inflator tube >>> **Fig. 29** ③ into the sealant bottle. The bottle's seal will break automatically.
- Remove the lid from the filling tube >>> **Fig. 29** ③ and screw the open end of the tube into the tyre valve.
- With the bottle upside down, empty **all** of the contents into the tyre.

- Remove the bottle from the valve.
- Place the insert back into the tyre valve using the tool >>> **Fig. 29** ①.

#### Inflating the tyre

- Screw the compressor tyre inflator tube >>> **Fig. 29** ⑧ into the tyre valve.
- Check that the air bleed screw is closed >>> **Fig. 29** ⑥.
- Start the engine and leave it running.
- Insert the connector >>> **Fig. 29** ⑨ into the vehicle's 12-volt socket >>> page 135.
- Turn the air compressor on with the ON/OFF switch >>> **Fig. 29** ⑤.
- Keep the air compressor running until it reaches 2.0 to 2.5 bar (29-36 psi/200-250 kPa). **A maximum of 8 minutes.**
- Disconnect the air compressor.
- If it does not reach the pressure indicated, unscrew the tyre inflator tube from the valve.
- Move the vehicle 10m so that the sealant is distributed throughout the tyre.
- Screw the compressor tyre inflator into the valve.
- Repeat the inflation process.
- If the indicated pressure still cannot be reached, the tyre is too badly damaged. Stop and request assistance from an authorised technician.

- Disconnect the air compressor. Unscrew the tyre inflator tube from the tyre valve.
- When the tyre pressure is between 2.5 and 2.0 bars, continue driving without exceeding 80 km/h (50 mph).
- Attach the sticker >>> **Fig. 29** ② to the instrument cluster, within the driver's visual field.
- Check the pressure again after 10 minutes >>> page 41.

#### WARNING

When inflating the wheel, the air compressor and the inflator tube may become hot.

- Protect hands and skin from hot parts.
- Do not place the hot flexible inflator tube or hot air compressor on flammable material.
- Allow them to cool before storing the device.
- If it is not possible to inflate the tyre to at least 2.0 bars (29 psi / 200 kPa), the tyre is too badly damaged. The sealant is not in a good condition to seal the tyre. Do not continue driving. Seek specialist assistance.

#### ① CAUTION

Switch off the air compressor after a maximum of 8 operational minutes to avoid overheating! Before switching on the air compressor again, let it cool for several minutes.

## Check after 10 minutes of driving

Screw the inflator tube >>> Fig. 29 ⑤ again and check the pressure on the gauge ⑥.

### 1.3 bar (19 psi / 130 kPa) and lower:

- **Stop the vehicle!** The tyre cannot be sealed sufficiently with the tyre mobility set.
- You should obtain professional assistance >>> ⚠.

### 1.4 bar (20 psi / 140 kPa) and higher:

- Set the tyre pressure to the correct value again.
- Carefully resume your journey until you reach the nearest specialised workshop without exceeding 80 km/h (50 mph).
- Have the damaged tyre replaced.

## ⚠ WARNING

Driving with an unsealed tyre is dangerous and can cause accidents and serious injury.

- Do not continue driving if the tyre pressure is 1.3 bar (19 psi / 130 kPa) and lower.
- Seek specialist assistance.

## Changing a wheel

### What to do first

- Park the vehicle on a horizontal surface and in a safe place as far away from traffic as possible.
- Apply the electronic parking brake.
- Switch on the hazard warning lights.
- Move the selector lever to the **P** position.
- If you are towing a trailer, unhitch it from your vehicle.
- Have the vehicle tool kit >>> page 38 and the spare wheel\* ready >>> page 338.
- Observe the applicable legislation for each country (reflective vest, warning triangles, etc.).
- All occupants should leave the vehicle and wait in a safe place (for instance behind the roadside crash barrier).

## ⚠ WARNING

- Always observe the above steps and protect yourself and other road users.
- If you change the wheel on a slope, block the wheel on the opposite side of the car with a stone or similar to prevent the vehicle from moving.

## Wheel bolt caps



Fig. 30 Wheel: wheel nuts with caps.

### Removal

- Fit the plastic clip (vehicle tools >>> Fig. 28) over the cap until it clicks into place >>> Fig. 30.
- Remove the cap with the plastic clip.

The caps protect the wheel nuts and should be remounted after changing the tyre.

The **anti-theft wheel locking bolt** has a special cap. This only fits on anti-theft locking bolts and is not for use with standard wheel nuts.

## Anti-theft wheel nuts

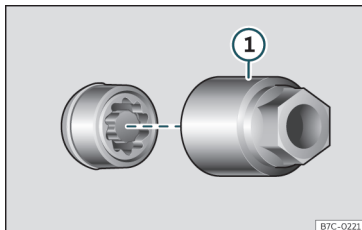

**Fig. 31** Anti-theft wheel bolt with cap and adapter.

### Loosening the anti-theft wheel bolt

- Remove the wheel cover\* or the cap\*.
- Insert the special adapter >>> **Fig. 31** ① (vehicle tools >>> page 38) onto the anti-theft wheel bolt and push it on as far as it will go.
- Insert the wheel brace (vehicle tools) onto the adapter as far as it will go.
- Remove the wheel bolt >>> page 42.

#### **i** Note

Make a note of the code number of the anti-theft wheel bolt and keep it in a safe place, but not in your vehicle. If you need a new adapter, you can obtain it from the specialised CUPRA service or the SEAT Official Service, indicating the code number.

## Loosening wheel nuts



**Fig. 32** Wheel change: loosen the wheel nuts.

Use only the wheel wrench belonging to the car to loosen the wheel nuts.

Loosen the wheel nuts only about one turn before raising the vehicle with the jack.

If the wheel bolt is very tight, carefully push on the end of the wheel wrench with your foot. Hold on to the vehicle for support and take care not to slip during this operation.

### Loosening wheel nuts

- Fit the wheel wrench on as far as it will go >>> **Fig. 32**.
- Hold the wrench at the end and rotate the bolt approximately *one* turn anticlockwise >>> **⚠**.

## Important information about wheel nuts

Factory-fitted rims and wheel nuts are specially matched during construction. Therefore, if different rims are fitted, the correct wheel nuts with the right length and heads must be used. This ensures that wheels are fitted securely and that the brake system functions correctly.

In certain circumstances, you should not even use wheel nuts from vehicles of the same model.

#### **⚠ WARNING**

If the wheel nuts are not properly tightened, they could come loose while driving and cause an accident, serious injury and loss of vehicle control.

- Use only wheel nuts which correspond to the rim in question.
- Never use different wheel nuts.
- Wheel nuts and threads should be clean, free of oil and grease, and it should be possible to screw them easily.
- To loosen and tighten wheel nuts, only use the wheel wrench that came with the car from the factory.
- The wheel nuts should only be loosened slightly (about one turn) before raising the vehicle with the jack. Risk of accident!
- Never apply grease or oil to wheel nuts or to the wheel hub threads. Even if the bolts have been tightened to the prescribed

torque, they could come loose while driving.

- Never loosen the screwed joints of wheel rims with bolted ring trims.
- If wheel nuts are tightened below the prescribed torque, the bolts and rims could come loose while driving. If tightening torque is too high, the wheel nuts or threads can be damaged.

## Raise the vehicle

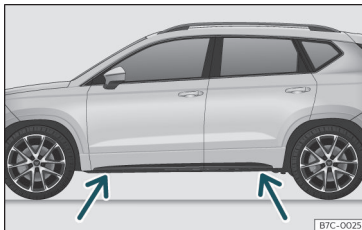

Fig. 33 Jack position points.

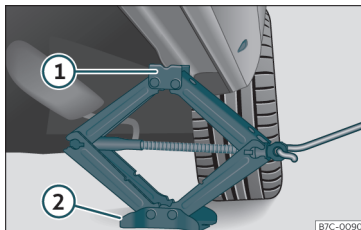

Fig. 34 Cross member: positioning the jack on the vehicle.

- Place the jack\* (vehicle tools) on firm ground. If necessary use a large, strong board or similar support. If the surface is slippery (for example tiles) place the jack on a rubber mat or similar to prevent it from slipping >>> ⚠.
- Find the support point on the strut (sunken area) closest to the wheel to be changed >>> Fig. 33.
- Turn the jack\* crank handle, located below the strut support point, to raise it until the tab ① >>> Fig. 34 is below the housing provided.
- Align the jack\* so that tab ① “grips” onto the housing provided on the strut and the mobile base ② is resting on the ground. The base plate ② should fall vertically with respect to the support point ①.
- Continue turning the jack\* until the wheel is slightly lifted off the ground.

## ⚠ WARNING

The factory-supplied jack\* is only designed for changing wheels on this model. On no account attempt to use it for lifting heavier vehicles or other loads. Risk of injury.

- Make sure that the jack\* remains stable. If the surface is slippery or soft, the jack\* could slip or sink, respectively, with the resultant risk of injury.
- Only raise the vehicle with the jack\* supplied by the manufacturer. Other jacks, even those approved for other CUPRA models could slip, with the consequent risk of injury.
- Only mount the jack\* on the support points designed for this purpose on the strut, and always align the jack correctly. If you do not, the jack\* could slip as it does not have an adequate grip on the vehicle: risk of injury!
- You should never place a body limb such as an arm or leg under a raised vehicle that is solely supported by the jack.
- If you have to work underneath the vehicle, you must use suitable stands additionally to support the vehicle, there is a risk of accident!.
- Never raise the vehicle if it is tilting to one side or the engine is running.
- Never start the engine when the vehicle is raised. The vehicle may come loose from the jack due to the engine vibrations.

»

### ⓘ CAUTION

The vehicle must not be raised on the crossbar. Only place the jack\* on the points designed for this purpose on the strut. Otherwise, the vehicle may be damaged.

### Removing and installing a wheel

Change the wheel after loosening the wheel nuts and raising the vehicle with the jack.

When removing/fitting the wheel, the rim may hit and damage the brake disc. For this reason, please take care and get a second person to assist you.

#### Taking off the wheel

- Unscrew the wheel nuts using the box spanner and place them on a clean surface.
- Take off the wheel.

#### Putting on the spare wheel

Check the direction of rotation of the tyre >>> page 44.

- Place the spare wheel or temporary spare wheel into position.
- Screw on the wheel nuts in position and tighten them loosely with a box spanner.
- To tighten the anti-theft locking wheel nuts use the corresponding adaptor.

- Carefully lower the vehicle using the jack\*.
- Use the wheel spanner to tighten all of the wheel nuts clockwise. Tighten the bolts in diagonal pairs (not in a circle).
- Put the caps, trim or full hubcap back on.

The wheel nuts should be clean and turn easily. Before fitting the spare wheel, inspect the wheel condition and hub mounting surfaces. These surfaces must be clean before fitting the wheel.

#### Tightening torque of the wheel nuts

The prescribed tightening torque for wheel nuts for steel and alloy wheels is **140 Nm**. After changing a wheel, have the tightening torque checked immediately with a torque wrench that is working perfectly.

**Before checking** tightening torque, have any rusty wheel nuts that are difficult to screw replaced and clean the wheel hub threads.

Never apply grease or oil to wheel nuts or to the wheel hub threads. Even if the bolts have been tightened to the prescribed torque, they could come loose while driving.

#### Tyres with directional tread pattern

Tyres with directional tread pattern have been designed to operate best when rotat-

ing in only one direction. An arrow on the tyre sidewall indicates the direction of rotation on tyres with directional tread. Always observe the indicated direction of rotation in order to guarantee optimum grip and help avoid aquaplaning, excessive noise and wear.

If the tyre is mounted in the opposite direction of rotation, drive with extreme caution, as the tyre is no longer being used correctly. This is of particular importance when the road surface is wet. Change the tyre as soon as possible or remount it with the correct direction of rotation.

#### Works after changing a wheel

- Replace the wheel bolt caps.
- Return all tools to their proper storing location.
- If the replaced wheel does not fit in the spare wheel housing, store it safely in the luggage compartment >>> page 124.
- Check the tyre pressure of the newly mounted tyre as soon as possible.
- In vehicles fitted with a tyre pressure indicator, adjust the pressure and store it in memory >>> page 337.

- Have the tightening torque of the wheel nuts checked as soon as possible with a torque wrench >>> page 44. Meanwhile, drive carefully.
- Have the flat tyre replaced as quickly as possible.

## Changing the windscreen wiper blades

### Wiper service position

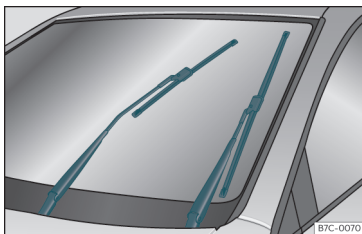

Fig. 35 Wipers in service position.

Ensure that the wiper blades are not frozen. The wiper arms can be raised when the wipers are in service position >>> Fig. 35.

- Close the bonnet >>> page 316.
- Switch the ignition on and off.

- Press the windscreen wiper lever downwards briefly >>> page 114 ④.

Before driving, always lower the wiper arms. Using the windscreen wiper lever, the windscreen wiper arms return to their initial position.

#### Note

- The windscreen wiper arms can be moved to the service position only when the bonnet is properly closed.
- You can also use the service position, for example, if you want to fix a cover over the windscreen in the winter to keep it clear of ice.

### Changing the wiper rear wiper blades

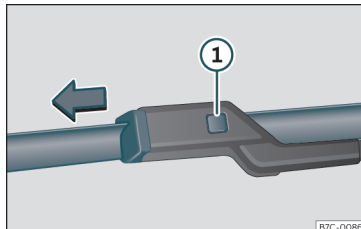

Fig. 36 Changing the windscreen wiper blades

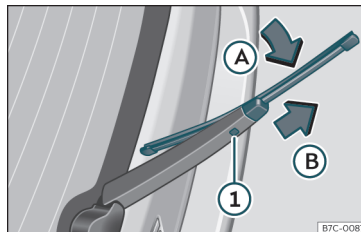

Fig. 37 Changing the rear wiper blade

The windscreen wiper blades are supplied as standard with a layer of graphite. This layer is responsible for ensuring that the wipe is silent. If the graphite layer is damaged, the noise of the water as it is wiped across the windscreen will be louder.

Check the condition of the wiper blades regularly. **If the wipers scrape across the glass**, they should be changed if they are damaged, or cleaned if they are dirty >>> ①.

If this does not produce the desired results, the setting angle of the windscreen wiper arms might be incorrect. They should be checked by a specialised workshop and corrected if necessary.

Damaged windscreen wiper blades should be replaced immediately. These are available from qualified workshops. >>>

### Raising and lowering windscreen wiper arms

- Place the windscreen wipers in the service position »» page 45.
- Grip the wiper arms **only** by the blade's fastening point.

### Cleaning windscreen wiper blades

- Raise the wiper arms.
- Use a soft cloth to remove dust and dirt from the windscreen wiper blades.
- If the blades are very dirty, a sponge or damp cloth may be used »» ❶.

### Changing the windscreen wiper blades

- Lift and unfold the wiper arms.
- Press and hold release button »» Fig. 36 ❶ and pull gently on the wiper blade in the direction of the arrow.
- Fit a new wiper blade of the **same length and design** on to the wiper arm and hook it into place.
- Rest the wiper arms back onto the windscreen.

### Changing the rear wiper blade

- Lift and fold the wiper arm.
- Turn the blade slightly »» Fig. 37 (arrow ❶).

- Hold down the release button ❶ while gently pulling the blade in the direction of arrow ❷.
- Insert a new blade of the **same length and type** in the rear wiper arm in the opposite direction to the arrow ❷ and hook into place button ❶.
- Replace the wiper arm on the rear window.

#### ⚠ WARNING

Worn or dirty windscreen wiper blades reduce visibility and increase the risk of accident and serious injury.

- Always replace damaged or worn windscreen wiper blades or blades that no longer clean the windscreen properly.

#### ❗ CAUTION

- Damaged or dirty windscreen wipers could scratch the glass.
- If products containing solvents, rough sponges or sharp objects are used to clean the blades, the graphite layer will be damaged.
- Never use fuel, nail varnish remover, paint thinner or similar products to clean the windows.
- In icy conditions, always check that the wiper blades are not frozen to the glass before using the wipers. In cold weather, it may help to leave the vehicle parked with the wipers in service position »» page 45.

#### ❗ CAUTION

- To prevent damage to the bonnet and the wiper arms, only leave them in the service position.
- Before driving, always lower the wiper arms.

## Jump start

### Jump leads

The jump lead must have a sufficient wire cross section.

If the engine fails to start because of a discharged battery, the battery can be connected to the battery of another vehicle to start the engine.

Jump leads must comply with standard **DIN 72553** (see cable manufacturer's instructions). The wire cross section must be at least 25 mm<sup>2</sup> for petrol engines and at least 35 mm<sup>2</sup> for diesel engines.

#### ❗ Note

- The vehicles must not touch each other, otherwise electricity could flow as soon as the positive terminals are connected.
- The discharged battery must be properly connected to the on-board network.



## Jump start: description

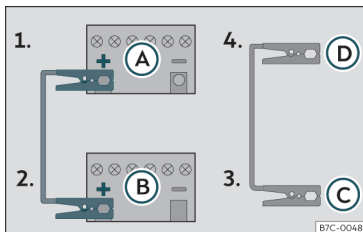

Fig. 38 Diagram of connections for vehicles with Start Stop system

## Jump lead terminal connections

1. Switch off the ignition of both vehicles  
»»  $\triangle$ .
2. Connect one end of the *red* jump lead to the positive (+) terminal of the vehicle with the flat battery (A).
3. Connect the other end of the *red* jump lead to the positive terminal (+) in the vehicle providing assistance (B).
4. Connect one end of the *black* jump lead (C) to a suitable ground terminal, to a solid piece of metal in the engine block, or to the engine block itself.
5. Connect the other end of the *black* jump lead (D) to a solid metal component bolted to the engine block or to the engine block itself of the vehicle

with the flat battery. Do not connect it to a point near the battery.

6. Position the leads in such a way that they cannot come into contact with any moving parts in the engine compartment.

## Starting

7. Start the engine of the vehicle with the boosting battery and let it run at idling speed.
8. Start the engine of the vehicle with the flat battery and wait for 2 or 3 minutes until the engine is running.

## Removing the jump leads

9. Before you remove the jump leads, switch off the dipped beam headlights if they are switched on.
10. Turn on the heater blower and heated rear window in the vehicle with the flat battery. This helps minimise voltage peaks which are generated when the leads are disconnected.
11. When the engine is running, disconnect the leads in reverse order to the details given above.

Make sure the battery clamps have sufficient metal-to-metal contact with the battery terminals.

If the engine fails to start after about 10 seconds, switch off the starter and try again after about 1 minute.

$\triangle$  **WARNING**

- Please note the safety warnings referring to working in the engine compartment  
»» page 316.
- The battery providing assistance must have the same voltage as the flat battery (12V) and approximately the same capacity (see imprint on battery). Failure to comply could result in an explosion.
- Never use jump leads when one of the batteries is frozen. Danger of explosion! Even after the battery has thawed, battery acid could leak and cause chemical burns. If a battery freezes, it should be replaced.
- Keep sparks, flames and lighted cigarettes away from batteries, danger of explosion. Failure to comply could result in an explosion.
- Observe the instructions provided by the manufacturer of the jump leads.
- Do not connect the negative cable from the other vehicle directly to the negative terminal of the flat battery. The gas emitted from the battery could be ignited by sparks. Danger of explosion.
- Never attach the negative cable to fuel system components or the brake lines in the other vehicle.

»

- The non-insulated parts of the battery clamps must not be allowed to touch. The jump lead attached to the positive battery terminal must not touch metal parts of the vehicle, this can cause a short circuit.
- Position the leads in such a way that they cannot come into contact with any moving parts in the engine compartment.
- Do not lean on the batteries. This could result in chemical burns.

### Note

The vehicles must not touch each other, otherwise electricity could flow as soon as the positive terminals are connected.

## Tow start and towing

### Introduction

**Tow-starting** means starting the engine of the vehicle while another pulls it.

**Towing** means one vehicle pulling another that is not roadworthy.

Always consider the legal provisions relating to tow-starting and towing.

For technical reasons, towing a vehicle with a discharged battery is not allowed. The jump start should be used instead >>> page 46.

If the vehicle comes with the Keyless Access system, towing is only allowed with the ignition on!

The vehicle battery drains if the vehicle is towed with the engine switched off and the ignition connected. Depending on the battery charge status, the drop in voltage may be so large, even after just a few minutes, that no electrical device in the vehicle may work e.g. the hazard warning lights. In vehicles with the Keyless Access system, the steering wheel could lock >>> ⚠.

### ⚠ WARNING

A vehicle with no power should never be towed.

- When towing, never remove the ignition key or disconnect the ignition with the start button. Otherwise, the electronic lock of the steering column could suddenly become blocked and it would be impossible to steer the vehicle. This could cause an accident, serious injury and loss of control of the vehicle.
- If during towing the vehicle runs out of power, stop towing immediately and request the assistance of specialist personnel.

### ⚠ WARNING

Vehicle handling and braking capacity change considerably during towing. Please observe the following instructions to mini-

mise the risk of serious accidents and injury:

- As the driver of the vehicle being towed:
  - You should depress the brake much harder as the brake servo does not operate. Pay the utmost attention to avoid crashing into the towing vehicle.
  - More strength is required at the steering wheel as the power steering does not operate when the engine is switched off.
- As the driver of the towing vehicle:
  - Accelerate with particular care and caution.
  - Avoid sudden braking and manoeuvres.
  - Brake earlier than usual and more smoothly.

### ⓘ CAUTION

- To avoid damaging the vehicle, for example the paint, remove and replace the lid and towing eye carefully.
- Unburnt fuel could enter the catalytic converter and damage it during towing.

### Instructions for tow-starting

Vehicle's should not generally be tow-started. The jump start should be used instead >>> page 46.

For technical reasons, towing the following vehicles is **not** allowed:

- Vehicles with an automatic gearbox.
- If the vehicle battery is discharged, because in vehicles with the Keyless Access locking and ignition system the steering remains locked and the electronic parking brake cannot be deactivated nor can the electronic lock of the steering column be released if they are activated.
- If the battery is flat, it is possible that the engine control units may not operate correctly.

#### ⓘ CAUTION

When tow-starting, unburnt fuel could enter the catalytic converter and damage it.

#### ⓘ Note

The vehicle can only be tow-started if the electronic parking brake and, if appropriate, the electronic lock of the steering column are deactivated. If the vehicle has no power supply or there is an electric system fault, the engine must be tow-started to deactivate the electronic parking brake and the electronic lock of the steering column.

### Towing instructions

Towing requires some expertise and experience, especially when using a tow rope. Both drivers should be familiar with the difficulties involved in towing. For this reason, inexperienced drivers should abstain from towing.

During towing, it should be ensured that no impermissible tractive forces or shocks are generated. When towing on an unpaved road, there is always a risk of overloading and damaging the anchorage points.

During towing, the towing vehicle can signal the change of direction even with the hazard warning lights turned on. To do so, at the same time, the turn signal lever must be operated with ignition switched on. Meanwhile, the hazard warning lights will go off. When the turn signal lever is returned to the rest position, the hazard warning lights will be automatically reactivated.

#### Notes for the driver of the towed vehicle

- Leave the ignition on, so that the steering is not blocked, and the electronic parking brake may be deactivated and the turn signals and wash/wipe operated.
- More strength is required at the steering wheel as the power steering does not operate when the engine is switched off.

- You should depress the brake much harder as the brake servo does not operate. Avoid hitting the towing vehicle.

- Bear in mind the information and instructions in the manual of the vehicle to be towed.

#### Notes for the driver of the towing vehicle

- Accelerate with particular care and caution. Avoid sharp manoeuvres.
- Brake earlier than usual and smoothly.
- Bear in mind the information and instructions in the manual of the towed vehicle.

#### Tow rope or tow bar

It is safer for the vehicle to be towed using a tow bar, avoiding damage to the vehicle. A tow rope should only be used if a tow bar is not available.

A tow rope should be slightly elastic to avoid damage to both vehicles. It is advisable to use a tow rope made of synthetic fibre or similarly elastic material.

Only attach the tow rope or the tow bar to the towing eyes provided or a towing bracket.

If the vehicle has a **factory-fitted towing device**, towing with a tow bar is **only** permitted if it has been specially designed to be installed on a tow hitch »» page 303. »

### When the vehicle has to be towed:

Check whether the vehicle may be towed >>> page 50, Cases where towing the vehicle is not permitted.

The vehicle can be towed using a tow bar or tow rope in the normal way, with all four wheels on the road; it can also be towed with either the front or rear wheels lifted off the road.

- Switch the ignition on.
- Move the selector lever to the **N** >>> page 232 position.
- Do not allow the vehicle to be towed at speeds of over 50 km/h (30 mph).
- The vehicle must not be towed further than 50 km (30 miles).
- If a breakdown lorry is used, vehicles with automatic transmission are only allowed to be towed with the front wheels suspended.

### Towing vehicles with four-wheel drive (4Drive)

Four-wheel drive vehicles (4Drive) can be towed using a tow bar or tow rope. If the vehicle is towed with the front or rear axle suspended, the engine must be switched off, otherwise the transmission may be damaged.

### Cases where towing the vehicle is not permitted

- If, due to a fault, the gearbox is out of lubricant.
- If the vehicle battery is discharged, because the steering remains locked and, if appropriate, the electronic parking brake cannot be deactivated or the electronic lock of the steering column released.
- If a distance above 50 km needs to be travelled.
- When, for example, after an accident, the smooth rotation of the wheels or the steering operation cannot be guaranteed.

### When the vehicle is to tow another vehicle:

- Observe legal requirements.
- Keep in mind the instructions in the manual on towing vehicles.

lock of the steering column are deactivated. If the vehicle has no power supply or there is an electric system fault, the engine must be tow-started >>> page 46 to deactivate the electronic parking brake and the electronic lock of the steering column.

### CAUTION

If there is no oil in the gearbox or no lubricant in the automatic transmission the car may only be towed with the driven wheels lifted clear of the road, or transported on a special car transporter or trailer.

### Note

The vehicle can only be towed if the electronic parking brake and the electronic

## Front towline anchorage

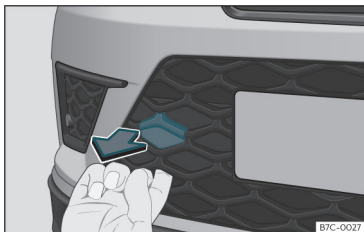

**Fig. 39** On the right side of the front bumper: remove the cover.



**Fig. 40** On the right side of the front bumper: towline anchorage in position.

The housing of the screw towing eye is on the right side of the front bumper behind a lid >>> **Fig. 39**.

The towing eye should always be kept in the vehicle.

Bear in mind the instructions for towing >>> page 49.

### Fitting the towline anchorage

- Remove the towing eye from the vehicle tool kit in the luggage compartment >>> page 38.
- Remove the lid of the towing eye by inserting a finger in the grid hole and pressing outward >>> **Fig. 39**.
- Remove the lid and let it hang from the vehicle.
- Screw the towing eye in the housing by turning it as far as it will go **anticlockwise** >>> **Fig. 40** >>> **!**. Use a suitable object that can completely and securely tighten the towing eye in its housing.
- After towing, unscrew the towing eye **clockwise** with a suitable object.
- Replace the lid by inserting the bottom part first and pressing until it fits into the bumper.
- Clean the towing eye if necessary and then store it in the luggage compartment along with the other vehicle tools.

### **!** CAUTION

The towing eye must always be completely and firmly tightened. Otherwise, it could be released while towing and tow-starting.

## Rear towline anchorage

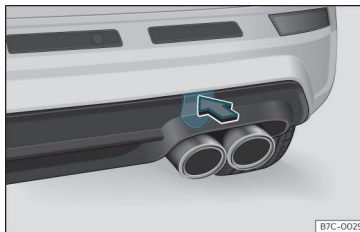

**Fig. 41** On the right side of the rear bumper: remove the cover.

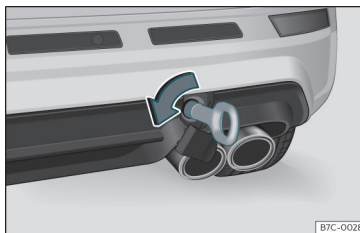

**Fig. 42** On the right side of the rear bumper: towline anchorage in position.

The housing of the screw towing eye is on the right side of the rear bumper behind a lid >>> **Fig. 41**.

Vehicles equipped as standard with a towing bracket **do not** have any housing for the »

screw towing eye behind the lid. In this case, the tow hitch needs to be extracted or installed and used for towing >>> page 303, >>> ❶.

Bear in mind the instructions for towing >>> page 49.

### Assemble the rear towing eye (cars without a factory-equipped towing bracket)

- Remove the towing eye from the vehicle tool kit in the luggage compartment >>> page 38.
- Press the upper side of the lid >>> Fig. 41 to unclip it.
- Remove the lid and let it hang from the vehicle.
- Screw the towing eye in the housing by turning it to the maximum **anticlockwise** >>> Fig. 42 >>> ❶. Use a suitable object that can completely and securely tighten the towing eye in its housing.
- After towing, unscrew the towing eye **clockwise** with a suitable object.
- Insert the upper flange of the lid into the opening of the bumper and press the lower side of the lid until it is inserted into the bumper.
- Clean the towing eye if necessary and then store it in the luggage compartment along with the other vehicle tools.

### ⚠ CAUTION

- The towing eye must always be completely and firmly tightened. Otherwise, it could be released while towing and tow-starting.
- If the vehicle is factory-equipped with a towing bracket, it is only allowed to tow with a tow bar if this has been specially designed to be installed with a tow hitch. If an unsuitable tow bar is used, both the tow hitch and the vehicle may be damaged. Instead, a tow rope should be used.

## Fuses and bulbs

### Fuses

#### Introduction

In general, a fuse can be assigned to various electrical components. Likewise, an electrical component can be protected by several fuses.

Only replace fuses when the cause of the problem has been solved. If a newly inserted fuse blows after a short time, you must have the electrical system checked by a specialised workshop as soon as possible.

#### ⚠ WARNING

The high voltages in the electrical system can give serious electrical shocks, causing burns and even death!

- Never touch the electrical wiring of the ignition system.
- Take care not to cause short circuits in the electrical system.

#### ⚠ WARNING

Using unsuitable fuses, repairing fuses or bridging a current circuit without fuses can cause a fire and serious injury.

- Never use a fuse with a higher value. Only replace fuses with a fuse of the same

amperage (same colour and markings) and size.

- Never replace a fuse by a metal strip, staple or similar.

### ⚠ CAUTION

- To prevent damage to the vehicle's electric system, before replacing a fuse always turn off the ignition, the lights and all electrical elements and remove the key from the ignition.
- Protect the fuse boxes when open to prevent the entry of dust or humidity as they can damage the electrical system.

### 📄 Note

- One component may have more than one fuse.
- Several components may run on a single fuse.
- In the vehicle, there are more fuses than those indicated in this chapter.

### Fuses inside the vehicle

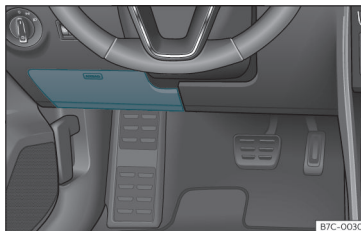

Fig. 43 Left hand drive vehicles: fuse box cover under the driver's side dashboard

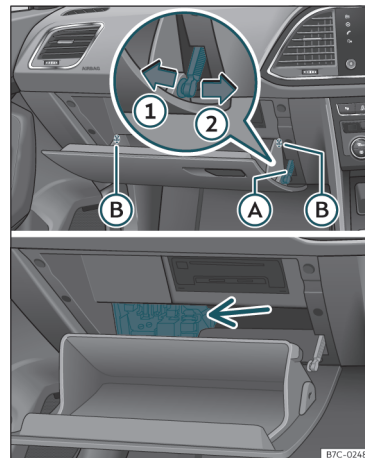

Fig. 44 Glove box (right hand drive): fuse box access.

Opening and closing the fuse box situated below the dash panel (left-hand steering wheel)

- *Open*: fold the cover down »» Fig. 43.
- *Close*: push back the cover it in until it clicks into place.

»

### Fuses behind the glove compartment (right-hand steering wheel)

- Open the glove compartment and, if necessary, empty it.
- Undo the opening limiter >>> Fig. 44 A in two steps: first, unlock the limiter by pulling back on it (arrow ①) and then move it gently to the right (arrow ②). Remove the guide when the cover is in the normal opening position (30°).
- Free the side pivots B to release the cover to its second opening position (60°).
- Follow the same procedure in reverse order to return the glove compartment to its normal position.

### Identifying fuses below the dashboard by colours

Colour	Amp rating
Black	1
Purple	3
Light brown	5
Brown	7.5
Red	10
Blue	15
Yellow	20
White or transparent	25

Colour	Amp rating
Green	30
Orange	40

#### ⓘ CAUTION

- Always carefully remove the fuse box covers and refit them correctly to avoid problems with your vehicle.
- Protect the fuse boxes when open to avoid the entry of dust or humidity. Dirt and humidity inside fuse boxes can cause damage to the electrical system.

### Fuses in the engine compartment

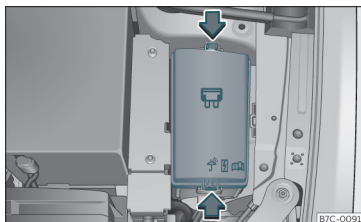

Fig. 45 In the engine compartment: fuse box cover.

#### To open the engine compartment fuse box

- Open the bonnet Δ >>> page 316.

- Press the locking tabs to release the fuse box cover >>> Fig. 45.
- Then lift the cover out.
- To fit the cover, place it on the fuse box. Push the locking tabs down until they click audibly into place.

### Replace a blown fuse

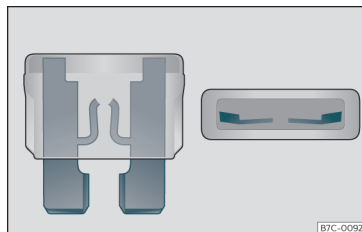

Fig. 46 Image of a blown fuse.

#### Preparations

- Switch off the ignition, lights and all electrical equipment.
- Open the corresponding fuse box >>> page 53, >>> page 54.

#### Recognise a blown fuse

A fuse is blown if its metal strip is ruptured >>> Fig. 46.



## Fuses and bulbs

- Point a lamp at the fuse to see if it has blown.

### To replace a fuse

- Remove the fuse.
- Replace the blown fuse by one with an *identical* amperage rating (same colour and markings) and *identical* size.
- Replace the cover again or close the fuse box lid.

### Fuse placement

Only replace fuses with a fuse of the same amperage (same colour and markings) and size.

### Fuses in the vehicle interior

No.	Consumers/Amps	
4	Alarm horn	7.5
5	Gateway	7.5
6	Automatic gearbox lever	7.5
7	Air conditioning and heating control panel, back window heating, auxiliary heating.	10
8	Diagnosis, electronic parking brake switch, light switch, reverse light, interior lighting, driving mode, lit-up door sill	7.5

No.	Consumers/Amps	
9	Steering column	7.5
10	Radio display	7.5
11	Left lights	40
12	Radio	20
14	Air conditioner fan	40
15	Steering column release	10
16	Connectivity Box	7.5
17	Instrument panel, OCU	7.5
18	Rear camera	7.5
19	Kessy	7.5
20	SCR, engine relay, 1.5	10/15
21	4x4 Haldex Control Unit	15
22	Trailer	15
23	Electric sunroof	20
24	Right lights	40
25	Left door	30
26	Heated seats	30
27	Interior light	30
28	Trailer	25
32	Control unit for parking aid, front camera and radar	7.5/10

No.	Consumers/Amps	
33	Airbag	7.5
34	Reverse switch, climate sensor, electrochromic mirror, rear power sockets (USB)	7.5
35	Diagnosis, headlight control unit, headlight adjuster	7.5
36	Right LED headlight	7.5
37	Left LED headlight	7.5
38	Trailer	25
39	Right door	30
40	12V socket	20
42	Central locking	40
43	Beats Audio CAN and MOST.	30
44	Trailer	15
45	Electric driver's seat	15
47	Rear window wiper	15
49	Starter motor; clutch sensor	7.5
50	Electric rear lid	40
52	Driving mode.	15
53	Heated rear window	30

In-line fuse	Amperes
Rear power sockets	7.5



### Fuse arrangement in engine compartment

No.	Consumers/Amps	
1	ESP control unit	25
2	ESP control unit	40
3	Engine control unit	30/15
4	Engine sensors	7.5
5	Engine sensors	7.5
6	Brake light sensor	7.5
7	Engine power supply	7.5/10
8	Lambda probe	10/15
9	Engine	5/10/20
10	Fuel pump control unit	15/20
11	PTC	40
12	PTC	40
13	Gearbox pump	30
14	Heated windscreen	40
15	Horn	15
16	Petrol pump	7.5/15/20
17	Engine control unit	7.5
18	Terminal 30 (positive reference)	7.5
19	Front windscreen washer	30
21	Automatic gearbox control unit	15/30

No.	Consumers/Amps	
22	Engine control unit	7.5
23	Starter motor	30
24	PTC	40
31	Pressure pump	15
37	Parking heating	20
46	230V socket	30

#### Note

- **In the vehicle, there are more fuses than those indicated in this chapter. These should only be changed by a specialised workshop.**
- **Positions not containing a fuse do not appear in the following tables.**
- **Some of the equipment listed in the tables below pertain only to certain versions of the model or are optional extras.**
- **Please note that the above lists, while correct at the time of printing, are subject to change.**

## Changing bulbs

### Introduction

#### Full-LED headlights

Full-LED headlights handle all light functions (daylight, side light, turn signal, dipped beam and route light) with light emitting diodes (LEDs) as a light source.

Full-LED headlights are designed to last the lifetime of the car and light bulbs cannot be replaced. In case of headlight failure, go to an authorised workshop to have it replaced.

#### Rear incandescent light bulbs

	Type
Turn signal	PY21W LL
Reverse lights	W16W
The remaining functions work with LEDs	

#### CAUTION

- **Remove the ignition key before working on the electric system. Otherwise, a short circuit could occur.**
- **Switch off the lights and the parking light before changing a bulb.**
- **Take good care to avoid damaging any components.**

### For the sake of the environment

Please ask your specialist retailer how to dispose of used bulbs in the proper manner.

### Note

- Please check at regular intervals that all lighting (especially the exterior lighting) on your vehicle is functioning properly. This is not only in the interest of your own safety, but also that of all other road users.
- Before changing a bulb, make sure you have the correct new bulb.
- Do not touch the glass part of the bulb with your bare hands, use a cloth or paper towel instead, since the fingerprints left on the glass will vaporise as a result of the heat generated by the bulb, they will be deposited on the reflector and will impair its surface.

### Tail light bulbs located in the body-work

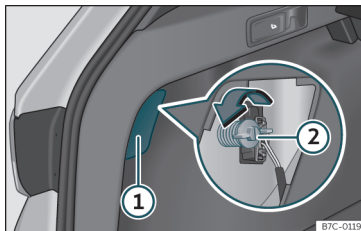

**Fig. 47** Luggage compartment: access to the bolt securing the tail light unit.

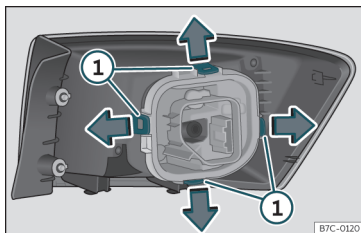

**Fig. 48** Retaining tabs on reverse side of tail light.

- Check which of the bulbs is defective.
- Open the rear lid.

- Remove the lid, levering it with the flat side of a screwdriver into the recess >>> **Fig. 47** ①.
- Remove the bulb connector.
- Unscrew the light securing bolt by hand or using a screwdriver >>> **Fig. 47** ②.
- Remove the light from the body, gently pulling it toward you, and place on a clean, smooth surface.
- Disassemble the bulb holder unlocking the securing tabs >>> **Fig. 48** ①.
- Change the damaged bulb.
- To refit follow the steps in reverse order, taking special care when fitting the bulb holder. The securing tabs must click into place.

### CAUTION

Take care when removing the rear light unit to make sure there is no damage to the paintwork or any of its components.

### Note

- Make sure you have a soft cloth ready to place under the glass on the rear light unit, to avoid any scratches.
- In the case of LED lights, change only the turn signal bulb.

### Tail lights bulbs located in the rear lid

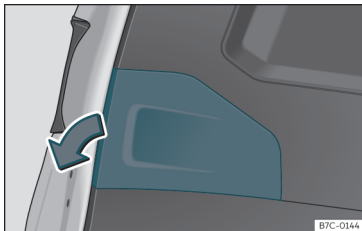

**Fig. 49** Rear lid open: remove the cover.

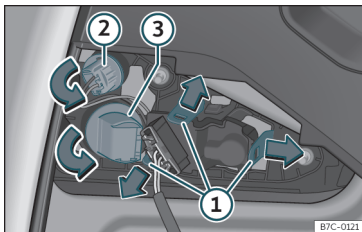

**Fig. 50** Remove the bulb holder.

The rear lid must be open to change the bulbs.

- Remove the rear lid cover in the direction indicated >>> **Fig. 49**.
- Unlock the securing tabs from the bulb holder >>> **Fig. 50** ① or turn the bulb holder to the left ②.

- Remove the bulb holder from its location.
- Lightly press the defective bulb into the bulb holder, then turn it to the left and remove it.
- Fit the new bulb, pressing it into the bulb holder and turn it to the right as far as it will go.
- Use a cloth to remove any fingerprints from the glass part of the bulb.
- Check that the new bulb works properly.
- Carry out the same actions in reverse order for assembly and pay special attention to placing the bulb holder, ensuring that the tabs are properly secured.

#### **i** Note

For LED pilots, you can only change the reverse bulb.

### Changing the number plate bulbs

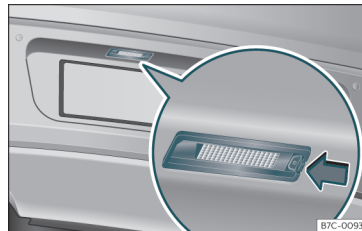

**Fig. 51** In the rear bumper: Number plate light.

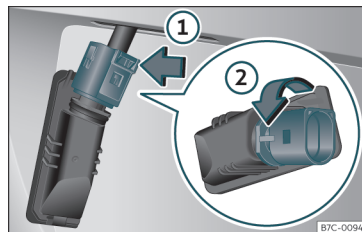

**Fig. 52** number plate light: remove the bulb holder.

Follow the steps indicated:

- Press the number plate light in the direction of the arrow >>> **Fig. 51**.
- Detach the number plate light.

- Turn the connector lock >>> **Fig. 52** in the direction of arrow ① and pull on the connector.
- Rotate the bulb holder in the direction of the arrow >>> **Fig. 52** ② and extract it together with the bulb.
- Replace the faulty bulb with a new identical bulb.
- Insert the bulb holder into the number plate light and rotate all the way in the opposite direction to the arrow >>> **Fig. 52** ③.
- Plug the connector into the bulb holder.
- Insert the number plate light carefully into the opening on the bumper. Ensure that the number plate light is in the correct position.
- Insert the number plate light into the bumper until it audibly clicks into place.

### **i** Note

Depending on how equipped the vehicle is, the number plate lights may be LEDs. LEDs have an estimated life that exceeds that of the car. If a light with LEDs fails, go to an authorised workshop for replacement.

### Side turn signals

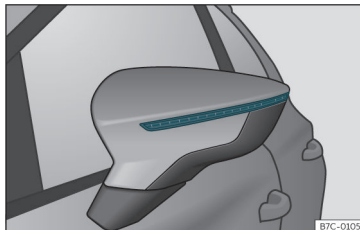

**Fig. 53** Turn signal integrated in the rear view mirror

The side turn signals are LEDs and are integrated in the exterior mirrors.

In case of failure, go to an authorised workshop to have them replaced.

### Additional brake light

Taking into account that it consists of LED bulbs, the change should be made at a technical service centre.

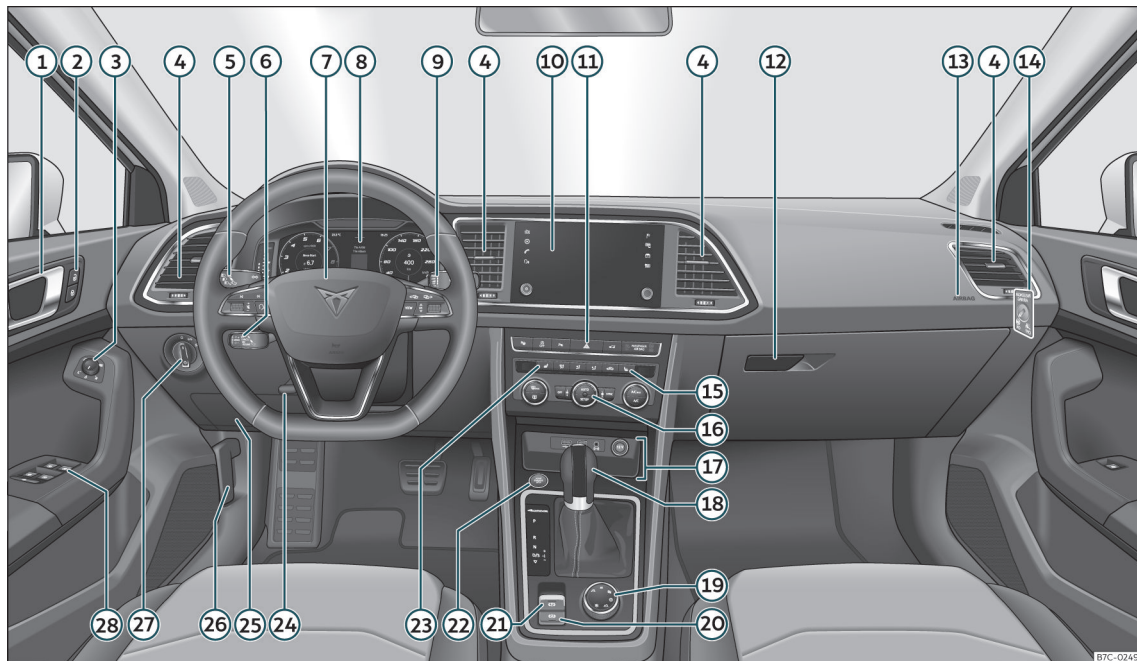

Fig. 54 Instruments and controls.

BTC-0249

## Operation

## Controls and displays

### Interior view

#### Overview

① Door handle			
② Central locking switch	89		
③ Control for the electric adjustment of the exterior mirrors	117		
④ Air vents	141		
⑤ Control lever for:			
– Turn signals and main beam headlights	109		
– Lane Assist	263		
– Main beam assist	110		
– Cruise control system (CCS)	246		
⑥ Depending on equipment fitted:			
– Lever for cruise control	246		
⑦ Steering wheel with horn and			
– Driver airbag	24		
– On-board computer controls	76		
– Controls for radio, telephone, navigation and speech dialogue system	144		
		– Paddle levers for tiptronic gear-shift (automatic gearbox)	234
⑧ Instrument panel	62		
⑨ Control lever for:			
– Windscreen wipers and washer	114		
– Wipe and wash system	114		
– On-board computer	67		
⑩ Easy Connect system (navigation, radio, TV/video)	144		
⑪ Depending on the equipment, buttons for:			
– Start-Stop system	230		
– Park assist system	290		
– Hazard warning lights	112		
– Tyre pressure switch	337		
– Airbag off display	25		
⑫ Depending on the equipment, glove compartment with:	133		
– CD player* and/or SD card*	186		
⑬ Front passenger airbag	24		
⑭ Front passenger airbag switch	25		
⑮ Front passenger seat heating control	142		
⑯ Automatic air conditioning controls	138		
⑰ Depending on the equipment:			
– USB/AUX-IN input	224		
		– Lighter/power socket	135
		– Connectivity Box/Wireless Charger*	224
		– Storage compartment	132
		⑱ DSG automatic gearbox lever	232
		⑲ Rotating control (Driving Experience button) for driving modes	241
		⑳ Auto Hold switch	278
		㉑ Electronic parking brake switch	274
		㉒ Start-up push button (Keyless Access closing and start-up system)	226
		㉓ Driver's seat heating control	142
		㉔ Steering column adjustment lever	14
		㉕ Knee airbag	26
		㉖ Bonnet lock release	318
		㉗ Headlight switch	107
		㉘ Electric windows	102

#### Note

- Some of the equipment listed in this section is only fitted on certain models or are optional extras.
- The arrangement of switches and controls on right-hand drive models\* may be slightly different from the layout shown in >>> page 60. However, the symbols used to identify the controls are the same.

## Instruments and warning/control lamps

### Instrument panel

#### Introduction

After switching the engine on with a 12-volt battery that is heavily discharged or newly changed some system settings (such as the time, the date, the personalised comfort settings and the programming) might be altered or deleted. Check and correct these settings once the battery is sufficiently charged.

#### WARNING

Any distraction may lead to an accident, with the risk of injury.

- Do not operate the instrument panel controls when driving.
- To reduce the risk of accident and injury, only make adjustments to the instructions on the screen of the instrument panel and to the instructions on the screen of the Infotainment system when the vehicle is stationary.



## Digital instrument panel (Digital Cockpit)

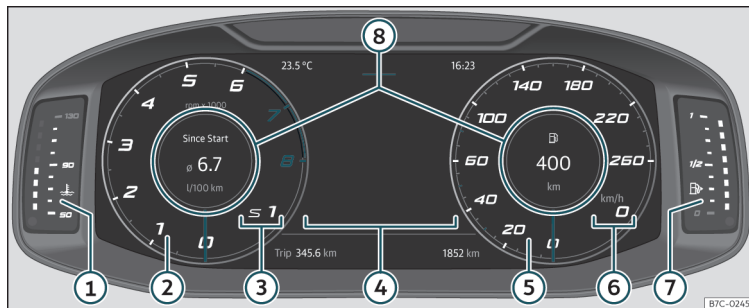

Fig. 55 Digital Cockpit on the instrument panel (classic view).

Details of the instruments:

- ① **Engine coolant temperature display**  
»» page 74
- ② **Revolution counter.** Revolutions per minute the engine is running »» page 73.
- ③ **Gear engaged or position of the selector lever currently selected**
- ④ **Screen display** »» page 65
- ⑤ **Speedometer**
- ⑥ **Digital speed display**
- ⑦ **Fuel gauge** »» page 73.
- ⑧ **Information Profile** »» page 63.

The Digital Cockpit is a digital instrument panel with a high-resolution TFT colour screen. It has a 4 views accessible using the

button **VIEW** of the multifunction steering wheel. By selecting different information profiles, indications other than the classic circular instruments can be displayed, such as navigation data, multimedia information or travel data.

The 4 views are:

- *Classic View*
- *Digital maps* (no information profiles)
- *Semicircular watches*
- *Sport*

All views will display information on the screen about audio, phone, travel data, vehicle status, navigation and driving aids.

In *Classic View* and *Semicircular watches* it is possible to customise the information displayed under **Information Profiles** »» Fig. 55 ⑧.

#### Information profiles

Through the **INSTRUMENT PANEL** option (infotainment button **VIEW** > **Instrument panel**) you can choose between the different display options of the information that appears in the Digital Cockpit.

#### Classic View

The revolutions per minute and speedometer needles appear along the entire length »» Fig. 55.

»

### View 1, 2, 3 or AUTOMATIC\*<sup>1)</sup>

Personalisation of the information that appears in the Digital Cockpit. Only 2 of these items of information can be displayed at the same time, but the user chooses which to display, and in what order, by moving the finger vertically over the dials.

Depending on the version, the Views can be memorised by exiting the menu or keeping the **View** button pressed.

- **Consumption.** Graphic representation of the current consumption and digital display of the average consumption.
- **Audio.** Digital display of the current audio playback.
- **Altitude.** Digital display of the current altitude above sea level.
- **Compass.** Digital display of the compass.
- **Information about the final destination.** Digital display of the remaining travelling time, distance to the destination and the estimated time of arrival.
- **Operating range.** Digital display of the remaining range.
- **Travel time.**
- **Route guidance.**

- **Journey.** Digital display of the distance travelled.
- **Assistance systems.** Graphic representation of different assistance systems.
- **Traffic signs.** Display of traffic signs detected.
- **Navigation.** Graphical representation of the navigation with arrows.

It may vary based on the features, the number and the contents of the selectable information profiles..

### Navigation map in the Digital Cockpit\*

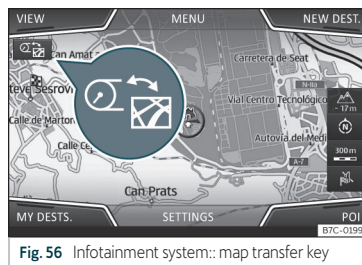

Fig. 56 Infotainment system:: map transfer key

Depending on the features, the Digital Cockpit can display a detailed map. To do this, select the **Navigation** option in the menu menu on the instrument panel >>> page 66.

Depending on the features, the navigation map can be displayed in the Digital Cockpit or on the Infotainment system or on both at the same time. If it is displayed only in the Infotainment system, the Digital Cockpit will only display the arrows for manoeuvres.

### Transfer of navigation map

Using the map transfer key >>> Fig. 56, the map is transferred from the Infotainment system to the Digital Cockpit and vice versa.

Using the right thumbwheel of the multi-function steering wheel, in the **Navigation** menu, you can transfer the map back to the Infotainment System.

<sup>1)</sup> Pre-set information depending on the "Driving mode" selected.

## Status display

### Possible indications on the instrument panel display

Different pieces of information can be displayed on the screen of the instrument panel, depending on the features of the vehicle.

- Doors, bonnet and rear lid open
- Warning and information messages
- Odometer
- Time »» page 73
- Indications of the radio and navigation system
- Indications of the phone
- Outside temperature
- Indications of the compass
- Selector lever positions
- Gear recommendation (Tiptronic mode) »» page 239
- Display of travel data (multifunction display) and menus for different settings »» page 66
- Service interval display »» page 75
- Speed warning »» page 67
- Speed warning for winter tyres
- Start-Stop system status display »» page 230
- Signs detected by the traffic signal detection system »» page 70

- Driver assistance system display »» page 246
- Copyright

### Doors, bonnet and rear lid open

When the vehicle is unlocked and while driving, the instrument panel display shows if any of the doors, the bonnet or rear lid are opened and, in some cases, it is also indicated by an audible warning. The display may vary according to the type of instrument panel fitted.

### Selector lever positions (DSG® dual clutch shift)

The current position of the selector lever is shown on the side of the lever and on the instrument panel display. When the lever is in the **D/S** position or in the Tiptronic position, in some cases, the gear engaged in each case is shown on the instrument panel display.

### Outside temperature indicator

If the outside temperature is lower than approximately +4 °C (+39 °F), the “ice crystal symbol” ❄ on the outside temperature display also lights up. This symbol remains lit until the outside temperature exceeds +6 °C (+43 °F) »» .

When the vehicle is stationary, when the auxiliary heater is switched on or when driv-

ing at very low speeds, the outside temperature indicated may be higher than the actual temperature due to the heat produced by the engine.

The margin of measurement ranges from -45 °C (-49 °F) to +76 °C (+169 °F).

### Gear-change recommendation

While driving, the instrument panel of certain vehicles may indicate a gear recommendation for saving fuel »» page 239.

### Odometer

The *odometer* registers the total distance travelled by the car.

The *partial odometer (trip)* shows the distance travelled since the last time it was reset to zero.

- Set the odometer to zero via the Infotainment system or the multifunction steering wheel »» page 67.

### Speed warning for winter tyres

If the maximum speed set is exceeded, this is displayed on the instrument panel »» page 66.

The speed warning can be adjusted on the Infotainment system, using the infotainment button  > **SETTINGS** > **Driver assistance** »» page 80. »

### Indications of the compass

Depending on the equipment, when the ignition is on, the instrument panel display indicates the direction in which you are driving with a symbol, e.g. NW for Northwest.

When the Infotainment system is on and there is no route guidance active, the graphic representation of a compass is also shown.

### Copyright

Legal text about the property rights and copyrights of the instrument cluster.

#### WARNING

Even when the outside temperature is higher than freezing temperature, some roads and bridges could be frozen.

- The "ice crystal symbol" indicates that there may be a risk of freezing.
- At outside temperatures above +4 °C (+39 °F), there may be ice even when the "ice crystal symbol" is not on.
- The outside temperature sensor takes a guideline measurement.

#### Note

- There are different instrument panels and therefore the versions and instructions on the display may vary. In the case of displays without warning or information texts,

faults are indicated exclusively by the control warning lamps.

- Some indications on the instrument panel screen may be concealed by a sudden event, e.g. an incoming call.
- Depending on the equipment, some settings and instructions can be carried out or displayed on the infotainment system as well.
- If there are several warnings at the same time, the symbols will be displayed one after the other for a few seconds. The symbols will stay on until you remove the cause.
- If when switching on the ignition warnings are shown about existing faults, it might not be possible to change the settings or show the information as described. In this case, go to a specialised workshop and request a repair.

### Instrument panel menus

The number of menus and information items available will depend on the vehicle's electronics and features.

A specialised workshop can programme or modify additional functions, according to the vehicle equipment. To do so, CUPRA recommends going to a specialised CUPRA dealer or any SEAT dealership.

Some menu options can only be read when the vehicle is stationary.

- **Driving data** >>> page 67
- **Assistance systems.**
  - Lane Assist On/Off >>> page 263
  - Front Assist On/Off >>> page 251
  - Blind spot detector On/Off >>> page 269
  - ACC (only display) >>> page 255
- **Navigation.**
- **Audio.**
- **Telephone.**
- **Vehicle status** >>> page 68

### Service Menu

In the Service menu various settings can be adjusted depending on the features.

#### Open the Service menu

To open up the **Service** menu, select the **Range** information profile while in the **Driving data** menu, and keep the  key pressed on the multifunction steering wheel for approximately 4 seconds. When it is released, the **Service** menu will be displayed. Now you can browse through the menu using the keys on the multifunction steering wheel as usual.

### Restart the service interval display

Select the **Service** menu and follow the instructions on the screen of the instrument panel.

### Restart the oil service

Select the **Restore Oil service** menu and follow the instructions on the instrument panel display.

### Restart journey data

Select the **Reset trip** menu and follow the instructions on the instrument panel display to reset the value.

### Identifying letters on engine (LDM)

Select the menu **Engine code**. The identifying letters of the engine will be shown on the instrument cluster display at the bottom left.

### Setting the clock

Select the **Time** menu and set the correct time by turning the right thumbwheel of the multifunction steering wheel.

### Driving data indicator (multifunction display)

The display of the travel data (multifunction display) shows different values about the journey and the consumption.

#### Change from one display to another

- Turn the right thumbwheel of the multifunction steering wheel »» page 76.

#### Changing memory

While in **Travel data > General information** press **OK** on the multifunction steering wheel to switch between the 3 memories<sup>1)</sup>:

**From start** The memory is deleted if the journey is interrupted for more than 2 hours.

**Since refuelling** Display and storage of the journey data and the consumption values collected. When refuelling, the memory is deleted.

**Long-term** This memory contains travel data up to a maximum of 19 hours and 59 minutes or 99 hours and 59 minutes, or up to a maximum of 1999.9 km or

9999.9 km. When one of these values is exceeded (varies depending on the version of the instrument panel), the memory is deleted.

#### Delete journey data presets

- Select the memory that you wish to erase.
- Keep the **OK** button on the multifunction steering wheel pressed for approximately 2 seconds.

#### Select the instructions

In the Infotainment system, in the menu **Vehicle settings**, you can display different travel data »» page 80.

**Current consumption** The current fuel consumption display operates throughout the journey, in litres/100 km; and with the engine running and the vehicle stopped, in litres/hour.

**Average consumption** The average fuel consumption is displayed after driving for approximately 300 metres.

**Travelling time** This indicates the hours (h) and minutes (min) since the ignition was switched on. »

<sup>1)</sup> This will show all data on the display at the same time: distance travelled, average consumption, average speed and autonomy.

**Range** Approximate distance in km that can still be travelled if the same driving style is maintained.



**Distance** Distance covered in km (m) after switching on the ignition.

**Average speed** The average speed will be shown after driving for approximately 100 metres.

**Digital speed** Current speed displayed in digital format.



**Convenience consumers** Displays a list of the connected comfort systems that increase energy consumption, e.g. air conditioning.

### Setting a speed warning

- Select the display **Warning at --- km/h** or **Speed warning at --- mph**.
- Press the  button on the multi-function steering wheel to memorise the current speed and activate the warning.
- *Activate*: set the desired speed within 5 seconds by rotating the wheel on the multi-function steering wheel. Next, press the  button again or wait several seconds. The speed is stored and the warning activated.
- *Deactivate*: press the  button. The stored speed is deleted.

The warning can be adjusted for speeds between 30 km/h (18 mph) and 250 km/h (155 mph).

### Display Oil temperature

The engine reaches its operating temperature when, under normal driving conditions, the oil temperature is between 80°C and 120°C. If the engine is under a lot of stress and the outside temperature is high, the engine oil temperature can increase. This does not present any problem as long as the warning lamps  or  >>> page 320 do not appear on the display.

### Warning and information messages (Vehicle status)

The system runs a check on certain components and functions when the ignition is switched on and while the vehicle is moving. Faults displayed on the instrument panel as red and yellow warning symbols accompanied with messages and, depending on the case, even an audible warning >>> page 77. The representation of the messages and symbols may vary depending on the version of the instrument panel.

Existing faults can also be checked manually. To do so, open the menu **Vehicle status** or **Vehicle** >>> page 66.

#### Priority 1 warning (red)

The symbol lights up or flashes (in part accompanied by audible warnings).  **Stop**

**driving!** Danger! Check the fault and eliminate the cause. If necessary, seek professional assistance.

#### Priority 2 warning (yellow)

The symbol lights up or flashes (in part accompanied by audible warnings). Operating faults or the lack of operating fluids can cause damage to the vehicle or a fault. Check the faulty function as soon as possible. If necessary, seek professional assistance.

#### Information message

It provides information about processes in the vehicle.

## Driver alert system (break recommendation)\*

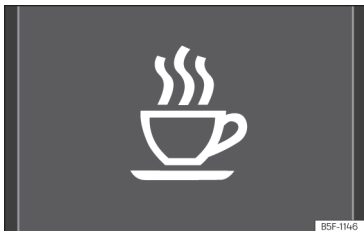

**Fig. 57** On the instrument panel display: driver alert system symbol.

The Fatigue detection informs the driver when their driving behaviour shows signs of fatigue.

### Function and operation

Fatigue detection determines the driving behaviour of the driver when starting a journey, making a calculation of tiredness. This is constantly compared with the current driving behaviour. If the system detects that the driver is tired, an audible warning is given with a sound and an optic warning is shown with a symbol and complementary message on the instrument panel display » **Fig. 57**. The message on the instrument panel display is shown for approximately 5 seconds,

and depending on the case, is repeated. The system stores the last message displayed.

The message on the instrument panel display can be switched off by pressing the **OK** button on the multi-function steering wheel » **page 76**.

The message can be recalled to the instrument panel display using the multifunction display » **page 67**.

### Conditions of operation

Driving behaviour is only calculated on speeds above about 65 km/h (40 mph) up to around 200 km/h (125 mph).

### Switching on and off

The driver alert system can be activated or deactivated in the Easy Connect system with the button **☰ > SETTINGS** » **page 80**. A mark indicates that the adjustment has been activated.

### System limitations

The Fatigue detection has certain limitations inherent to the system. The following conditions can limit the Fatigue detection or prevent it from functioning.

- At speeds below 65 km/h (40 mph)
- At speeds above 200 km/h (125 mph)
- When cornering

- On roads in poor condition
- In unfavourable weather conditions
- When a sporty driving style is employed
- In the event of a serious distraction to the driver

Fatigue detection will be restored when the vehicle is stopped for more than 15 minutes, when the ignition is switched off or when the driver has unbuckled their seat belt and opened the door.

In the event of slow driving during a long period of time (below 65 km/h, 40 mph) the system automatically re-establishes the tiredness calculation. When driving at a faster speed the driving behaviour will be recalculated.

### **⚠ WARNING**

**Do not let the comfort afforded by the Fatigue detection system tempt you into taking any risks when driving. Take regular breaks, sufficient in length when making long journeys.**

- **The driver always assumes the responsibility of driving to their full capacity.**
- **Never drive if you are tired.**
- **The system does not detect the tiredness of the driver in all circumstances. Consult the information in the section » **page 69**, System limitations.**

»

- In some situations, the system may incorrectly interpret an intended driving manoeuvre as driver tiredness.
- No warning is given in the event of the effect called microsleep!
- Please observe the indications on the instrument panel and act as is necessary.

### Note

- Fatigue detection has been developed for driving on motorways and well paved roads only.
- If there is a fault in the system, have it checked by a specialised workshop.

### Road signs detection system\*1)

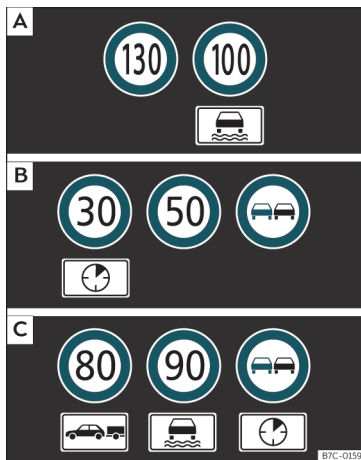

**Fig. 58** On the instrument panel display: examples of speed limits or overtaking prohibitions with their respective additional signs.

The traffic sign detection system records the standard traffic signs in front of the vehicle with a camera located on the base of the interior mirror and provides information about speed limits and overtaking prohibitions.

Within its limitations, the system also displays additional signals, such as time-specific prohibitions, signs for vehicles towing trailers >>> page 303 or limitations that only apply in the event of rain. Even on journeys without signs, the system may display any applicable speed limits.

The traffic sign detection system does not work in all countries. Keep this in mind when travelling abroad.

### Shown on the display

In Germany, on motorways and vehicle roads, besides speed limits and overtaking provisions the system also displays the end of prohibition signs. The valid speed limit at the time in other countries is always shown.

The traffic signs detected by the system are displayed on the dash panel display >>> Fig. 58 and, depending on the navigation system fitted in the vehicle, on the infotainment system as well >>> page 80.

### Road sign detection system messages:

#### There are no traffic signs available

- The system is in its start-up phase.
- **OR**: the camera has not recognized any mandatory or prohibitive sign.

<sup>1)</sup> System available depending on the country.



### Error: Dynamic Road Sign Display

- There is a fault in the system. Have the system checked by a specialised workshop.

### Speed warning currently unavailable

- The speed warning function of the road sign detection system is faulty. Have the system checked by a specialised workshop.

### Dynamic Road Sign Display: please clean the windscreen.

- The windscreen is dirty in the camera area. Clean the windscreen.

### Dynamic Road Sign Display currently restricted.

- The navigation system is not transmitting data. Check if the navigation system has updated maps.
- **OR:** the vehicle is in a region not included on the navigation system's map.

### No data available

- The traffic sign detection system does not work in the current country.

### Activate and deactivate the road sign display on the instrument panel

The permanent display of traffic signs on the instrument panel can be activated or deactivated in the infotainment system using the button  > **SETTINGS** > **Driver assistance**.

### Display of traffic signs

When the traffic sign detection system is connected, a camera located on the base of the interior rear-view mirror records the traffic signs in front of the vehicle. After checking and evaluating the information from the camera, the navigation system and the current vehicle data, up to three valid traffic signs are displayed >>> **Fig. 58 B** in conjunction with their corresponding additional signs.

First: The sign that is currently valid for the driver is shown in the left side of the screen. For example, a maximum speed limit of **130 km/h (100 mph)** >>> **Fig. 58 A**.

Second: A sign valid only in certain circumstances, e.g. **100 km/h (60 mph)** is shown second, together with the additional rain sign.

Additional sign: If the windscreen wiper is working while you are driving, the signal with the additional rain sign will be shown first, on the left, as it is the one that is applicable at the time.

Third: A sign valid only with restrictions, e.g. No overtaking at certain times, will be displayed third >>> **Fig. 58 C**.

### Speed warning

If the system detects that the permitted speed is exceeded, it may warn the driver

with a “gong” and visually with a message on the dash panel display.

The speed warning can be adjusted or deactivated completely in the infotainment system using the button  > **SETTINGS** > **Driver assistance** >>> page 80. The speed is adjusted in steps of 5 km/h (3 mph) within a range of between 0 km/h (mph) and 20 km/h (12 mph) above the maximum speed permitted.

### Trailer mode

In vehicles equipped with a towing bracket device from the factory and a trailer that is electrically connected to the vehicle, it is possible to activate or deactivate the display of specific traffic signs for vehicles with trailer, such as speed limits or overtaking prohibitions. Activation or deactivation is performed in the infotainment system using the button  > **SETTINGS** > **Driver assistance** >>> page 80.

For trailer mode, the display of speed limits applicable to the type of trailer or to the legal provisions can be adjusted. The speed is adjusted in steps of 10 km/h (5 mph) within a range of between 60 km/h (40 mph) and 130 km/h (80 mph). If it is adjusted to a speed greater than that which is permitted in the country in question for driving with a trailer, the system automatically displays the usual speed limits, e.g. in Germany 80 km/h (50 mph).

If the speed warning for the trailer is deactivated, the system displays the speed limits as if there were no trailer hitched.

### Limited operation

The traffic sign detection system has certain limitations. The following cases may lead the system to operate with limitations or not at all:

- In the case of poor visibility, e.g. in snow, rain, fog or intense mist.
- In cases of dazzling, e.g. caused by head-on traffic or by the sun.
- When driving at high speeds.
- If the camera is covered or dirty.
- If the traffic signs are out of the camera's field of vision.
- If the traffic signs are partially or totally covered, e.g. by trees, snow, dirt or other vehicles.
- In the case of traffic signs that do not fulfil the regulations.
- In the case of damaged or bent traffic signs.
- In the case of variable messages on overhead or gantry signs (LED-based variable traffic signs or other lighting units).
- If the maps on the navigation system are not up-to-date.

• In the case of adhesives affixed to vehicles that depict traffic signs, e.g. speed limits on lorries.

### WARNING

The technology in the traffic sign detection system cannot change the limits imposed by the laws of physics and only works within the system's limits. Do not let the extra convenience afforded by the traffic sign detection system tempt you into taking any risks when driving. The system is not a replacement for driver awareness.

- Adapt your speed and driving style to suit visibility, weather, road and traffic conditions.
- Poor visibility, darkness, snow, rain and fog may lead to the system failing to display traffic signs or not displaying them correctly.
- If the camera's field of vision is dirty, covered or damaged, system operation may be impaired.

### WARNING

The driving recommendations and traffic indications shown on the traffic sign detection system may differ from the actual current traffic situation.

- The system may not detect or correctly show all the traffic signs.

• Traffic signs and traffic regulations have priority over the recommendations and displays provided by the system.

### WARNING

If messages are ignored, the vehicle may stall in traffic and cause accidents and severe injuries.

- Never ignore the messages displayed.
- Stop the vehicle at the next opportunity and in a safe place.

### Note

To avoid affecting the correct operation of the system, take the following points into consideration:

- Regularly clean the area of vision of the camera and keep it in a clean state, without snow or ice.
- Do not cover the field of vision of the camera.
- Always replace damaged or worn blades when required to avoid lines on the camera's field of vision.
- Check that the windscreen is not damaged in the area of the camera's field of vision.
- The use of outdated maps on the navigation system may cause the system to show traffic signs incorrectly.



- In the waypoints mode of the navigation system, the traffic sign detection system is only partly available.
- Failure to heed the control lamps and corresponding text messages when they light up may result in damage to the vehicle.

## Time

### Setting the time on the infotainment system

- Press the infotainment  button.
- Press the **SETTINGS** function button.
- Select the menu option **Time and date** to set the time >>> page 80.

### Adjusting the time in the Digital Cockpit

- While in the **Driving data** menu select the **Range** function (infotainment button  > **View > Driving data > Range**).
- Press the button  on the multifunction steering wheel until the Service menu is displayed on the instrument panel display >>> page 66.
- Select the menu **Time**.
- Adjust the correct time by turning the right thumbwheel of the multifunction steering wheel.

## Revolution counter

The rev counter indicates the number of engine revolutions per minute.

Together with the gear-change indicator, the rev counter offers you the possibility of using the engine of your vehicle at a suitable speed.

The beginning of the red zone of the rev counter indicates the maximum speed in any gear after running-in and with the engine hot. However, it is advisable to move the selector lever to **D** or lift your foot off the accelerator before the needle reaches the red zone >>> .

We recommend that you avoid high revs and that you follow the recommendations on the gear-change indicator. Consult the additional information in >>> page 239, **Selecting the optimal gear**.

### CAUTION

- To prevent damage to the engine, the rev counter needle should only remain in the red zone for a short period of time.
- When the engine is cold, avoid high revs and heavy acceleration and do not make the engine work hard.

## For the sake of the environment

Changing up a gear early will help you to save fuel and minimise emissions and engine noise.

## Fuel gauge



Fig. 59 Fuel gauge.

## Control lamps



It lights up, and in addition, the lower diode lights up in red

Fuel tank almost empty. The fuel reserve level has been reached >>> . Refuel as soon as you have the opportunity. When the fuel level is very low, the lower diode flashes red.

The display only works when the ignition is switched on. »

The fuel range is displayed on the instrument panel.

You can consult the tank capacity of your vehicle in the >>> page 355 section.

### ⚠ WARNING

When driving with low fuel, the vehicle may stall in traffic and cause accidents and severe injuries.

- If the fuel tank level is too low, fuel could reach the engine irregularly, particularly when driving up or down slopes.
- The steering system and the driver assistance systems and brakes do not work when the engine is running irregularly or switches off due to lack of fuel or an irregular supply thereof.
- Always refuel when there is only one quarter of fuel in tank to prevent the vehicle to stop due to lack of fuel.

### ⓘ CAUTION

Never run the fuel tank completely dry. An irregular fuel supply can cause misfiring and unburnt fuel could enter the exhaust system. The catalytic converter or the particulate filter may get damaged!

### i Note

The small arrow on the fuel gauge next to the fuel pump symbol points out towards

the side of the vehicle with the fuel tank flap.

### Engine coolant temperature indicator.

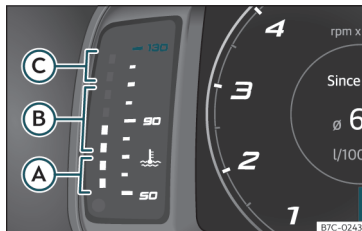



Fig. 60 Engine coolant temperature indicator.

>>> Fig. 60:

- (A) **Cool zone.** The engine has not reached operating temperature yet. Avoid high engine speeds and stressing the engine if it has not reached operating temperature.
- (B) **Normal zone.** At high outside temperatures and when making the engine work hard, the diodes may continue lighting up and reach the upper zone. This is no cause for concern, provided the control lamp does not light up .

- (C) **Warning area.** When the engine is working hard, especially at high outside temperatures, the diodes may light up in the warning area.

The coolant temperature gauge only works when the ignition is switched on.

### Control and warning lamp

#### It lights up red

 Do not carry on driving!  
Engine coolant level too low, coolant temperature too high.

#### Flashes red

Fault in the engine coolant system.

- Stop the vehicle, switch off the engine and let it cool down.
- Check the engine coolant level >>> page 322.
- If the warning lamp does not switch off even if the coolant level is correct, request assistance from specialised personnel.

### ⓘ CAUTION

• To ensure a long useful life for the engine, avoid high revs, driving at high speed and making the engine work hard for approximately the first 15 minutes when the engine is cold. The phase until the engine is warm also depends on the outside temperature.

If necessary, use the engine oil temperature\* »» page 68 as a guide.

- Additional lights and other accessories in front of the air inlet reduce the cooling effect of the coolant. At high outside temperatures and high engine loads, there is a risk of the engine overheating.
- The front spoiler also ensures proper distribution of the cooling air when the vehicle is moving. If the spoiler is damaged this can reduce the cooling effect, which could cause the engine to overheat. Seek specialist assistance.

### Service intervals

The service interval indication appears on the instrument panel display and the Infotainment system.

There are different versions of instrument panels and infotainment systems, so the versions and instructions on the screens may vary.

CUPRA distinguishes between services *with* engine oil change (e.g. Oil change service) and services *without* engine oil change (e.g. Inspection).

In vehicles with **Services established by time or mileage**, the service intervals are already pre-defined.

In vehicles with **LongLife Service**, the intervals are determined individually. Thanks to technological progress, maintenance work has been greatly reduced. Because of the technology used by CUPRA, with this service you only need to change the oil when the vehicle so requires. To calculate this variation (max. 2 years), the vehicle's conditions of use and individual driving styles are considered. The advance warning first appears 20 days before the date established for the corresponding service. The kilometres (miles) remaining until the next service are always rounded up to the nearest 100 km (miles) and the time is given in complete days. The current service message cannot be viewed until 500 km after the last service. Prior to this, only lines are visible on the display.

### Inspection reminder

If a service or an inspection has to be carried out soon, a **service reminder** will be displayed when the ignition is switched on.

The figure displayed are the kilometres that can still be travelled or the time until the next service.

### Service due

When the **time for a service** or an **inspection** comes, an audible warning will be emitted when the ignition is switched on and the fixed key symbol  may appear on the in-

strument panel for a few seconds, along with one of the following messages:

- **Service now!**
- **Please have your vehicle inspected.**
- **Oil change service due!**
- **Oil change service and inspection due!**

### Consult a service notification

With the ignition switched on, the engine off and the vehicle at a standstill, the current **service notification** can be read:

*Check the date of the current service on the infotainment system*

- Press the infotainment  button.
- Press the **SETTINGS** function button »» page 80.
- Select the **Service** menu option to display information about the services.

*Checking the date on the digital instrument panel*

- The date of the service can only be read through the Service menu »» page 66.

### Resetting service interval display

If the service was not carried out by a specialised CUPRA dealer or SEAT dealership, the display can be reset as follows: »

- The service interval display can only be re-set through the Service menu >>> page 66.

**Do not** restart the indicator between the service intervals, otherwise the information displayed will be incorrect.

If the oil change service is reset manually, the service interval display changes to a fixed service interval, also in vehicles with **Flexible oil change service**.

#### Note

- The service message disappears after a few seconds, when the engine is started or when the  button is pressed on the multifunction steering wheel.

- In vehicles with the LongLife system in which the battery has been disconnected for a long period of time, it is not possible to calculate the date of the next service. Therefore the service interval display may not be correct. In this case, bear in mind the maximum service intervals permitted >>> page 340.

- If you reset the display manually, the next service interval will be indicated as in vehicles with fixed service intervals. For this reason we recommend that the service interval display be reset by an authorised dealer.

## Using the instrument panel

### Introduction

With the ignition switched on, it is possible to read the different functions of the display by scrolling through the menus.

The multifunction display can only be controlled from the buttons on the multifunction steering wheel.

Some menu options can only be read when the vehicle is at a standstill.

### WARNING

Distracting the driver in any way can lead to an accident and cause injuries.

- Never use the menus on the instrument panel display while the vehicle is in motion.

#### Note

After loading or changing the 12-volt battery, check the system settings. If the power supply is interrupted, the system settings might be incorrect or deleted.



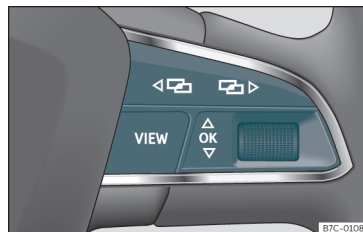

### Operation using the multifunction steering wheel



**Fig. 61** Right side of the multifunction steering wheel: buttons to the menus and information displays on the instrument panel.

As long as a priority 1 >>> page 68 warning is active, it will not be possible to access any menu. Some warnings can be confirmed and hidden with the button  of the multifunction steering wheel >>> **Fig. 61**.

#### Select a menu or an informative display

- Switch the ignition on.
- If a message or vehicle symbol is displayed, press the button  >>> **Fig. 61**; if necessary, several times.
- To change menus, use buttons  or  >>> **Fig. 61**.
- To open the menu or the information displayed, press the button  >>> **Fig. 61** or wait

a few seconds until the menu or the informative display opens automatically.

### Changing menu settings

- In the menu displayed, turn the right thumbwheel of the multifunction steering wheel >>> **Fig. 61** until the desired option of the menu is highlighted. The option appears framed.
- Press the button **OK** >>> **Fig. 61** to make the required modifications. A mark indicates that the system or function is activated.

### Back to menu selection

Press the button **←** or **→** >>> **Fig. 61**.

#### **i** Note

If when switching on the ignition warnings are shown about existing faults, it might not be possible to change the settings or show the information as described. In this case, go to a specialised workshop and request a repair.

### Button for the driver assistance systems\*

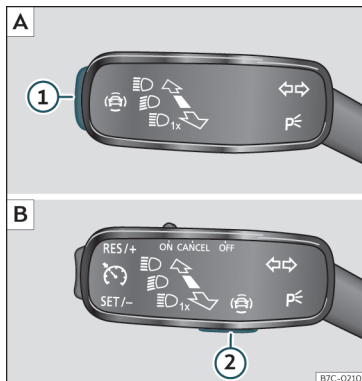

**Fig. 62** On the turn signal and main beam lever: button for driver assistance systems (depending on versions).

With the turn signal and main beam headlight lever button, you can activate or deactivate the driver assistance systems displayed in the **Assistance systems** menu.

### Activate or deactivate a driver assistance system

- Press >>> **Fig. 62** **1** or **2** briefly to open the **Driving aids** menu.

- Select the driver assistance system and activate or deactivate it >>> **page 76**. A mark indicates that driver assistance system is switched on.

- Next, confirm the selection by pressing the **OK** button on the multi-function steering wheel.

The driver assistance systems can also be switched on and off in the infotainment system, in the menu **Vehicle settings** >>> **page 80**.

## Control lamps

### Control and warning lamps







The control and warning lamps are indicators of warnings >>> **Δ**, faults or certain functions. Some control and warning lamps come on when the ignition is switched on, and switch off when the engine starts running, or while driving.

Depending on the model, additional text messages may be viewed on the instrument panel display. These may be purely informative or they may be advising of the need for action >>> **page 62**, **Instrument panel**. »





Depending upon the equipment fitted in the vehicle, instead of a warning lamp, sometimes a symbol may be displayed on the instrument panel.













When certain control and warning lamps are lit, an audible warning is also heard.



### Red warning lamps

	Notification central lamp: additional information on the instrument panel display
	Parking brake on >>> page 274.
	Fault in the brake system >>> page 274.
	Fault in the steering system >>> page 241.
	Driver or passenger has not fastened seat belt >>> page 15.
	Press the foot brake >>> page 256.













### Yellow warning lamps

	Notification central lamp: additional information on the instrument panel display
	Front brake pads worn >>> page 274.
	Fault in ESC or disconnection caused by the system; <b>OR</b> ESC or ASR in operation >>> page 279.
	ESC in Sport mode; <b>OR</b> ESC manually deactivated >>> page 279.







	Fault in the ABS >>> page 279.
	Rear fog light switched on >>> page 107.
	Fault in the emission control system >>> page 315.
<b>EPC</b>	Fault in the petrol engine management >>> page 315.
	Particulate filter blocked >>> page 315.
	Fault in the steering system >>> page 241.
	Tyre monitor system >>> page 337.
	Fuel tank almost empty >>> page 73.
	Fault in airbag system and seat belt tensioners >>> page 23.
<b>OFF</b> 	Front passenger front airbag is disabled >>> page 23.
<b>ON</b> 	The front passenger front airbag is activated >>> page 23.
	Lane assist warning (Lane Assist) >>> page 264.
	Error in the lane assist warning system >>> page 264.
	Fault in the lighting of the vehicle >>> page 107.

	Low engine oil level >>> page 320.
	Fault in the gearbox >>> page 238.
	Windscreen cleaning fluid too low >>> page 114.

### Other warning lamps

	Turn lights or emergency lights on >>> page 107.
	Trailer turn signals >>> page 107.
	Auto Hold activated >>> page 278.
	Press the foot brake >>> page 232.
	Cruise control (GRA) >>> page 246; <b>OR</b> speed limited >>> page 248; <b>OR</b> Adaptive cruise control (ACC) >>> page 256.
	Lane assist warning (Lane Assist) >>> page 264.
	Main beam on or flasher on >>> page 107.
	Door(s), rear lid or bonnet open or not properly closed >>> page 65.
	Engine cooling fluid >>> page 74.
	Engine oil pressure >>> page 320.
	Fault in the battery >>> page 327.
	Main beam assist (Light Assist) >>> page 107.
	Hill descent control (HDC) >>> page 239.



	Service interval display »» page 75.
	Mobile telephone is connected via Bluetooth* »» page 213.
	Mobile telephone battery charge status »» page 213.
	Risk of freezing »» page 65.
	Start-Stop system activated »» page 230.
	Start-Stop system unavailable »» page 230.

### WARNING

If the warning lamps and messages are ignored, faults may occur in the vehicle, it may stall in traffic, or accidents and serious injuries may occur.

- Never ignore the warning lamps or text messages.
- Stop the vehicle safely as soon as possible.
- A faulty vehicle represents a risk of accident for the driver and for other road users. If necessary, switch on the hazard warning lamps and put out the warning triangle to advise other drivers.
- Before opening the bonnet, switch off the engine and allow it to cool.
- In any vehicle, the engine compartment is a hazardous area and could cause severe injuries »» page 316.

## Easy Connect system

### Introduction

The infotainment system brings together important vehicle functions and systems into a single central control unit, e.g. menu settings, radio equipment and the navigation system.

### Vehicle menu settings

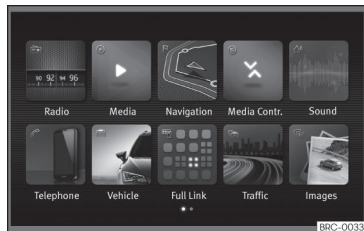

Fig. 63 Easy Connect: Main menu.

#### Open the Vehicle settings menu

- Switch the ignition on.
- If the Infotainment System is off, switch it on.

#### General operating information

The following section contains all of the relevant information for changing the settings in the **Vehicle Settings** menu. General information on the operation of the infotainment system, as well as on the warning and safety instructions that must be taken into account, is found in >>> page 144

#### ⚠ WARNING

Any distraction may lead to an accident, with the risk of injury. Operating the Easy Connect system while driving could distract you from traffic.

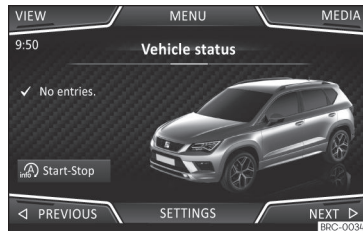

Fig. 64 Easy Connect: Vehicle Menu.

- Press the Infotainment button and then the **Vehicle** function button >>> Fig. 63.
- **OR:** Press the infotainment button to open the **Vehicle** menu >>> Fig. 64.
- Press the **SETTINGS** function button to open the **Vehicle settings** menu.
- To select a function in the menu, press the desired button.

Menu	Submenu	Possible setting	Description
ESC system	-	Selecting the ESC Sport mode or deactivating the electronic stability system (ESC)	>>> page 279

## Instruments and warning/control lamps

Menu	Submenu	Possible setting	Description
Tyres	Tyre pressure monitoring	Tyre pressure storing (Calibration)	»» page 337
	Winter tyres	Activation and deactivation of the speed warning, adjusting the speed warning value	»» page 335
Lights	Light assist	Dynamic Light Assist, Light Assist, motorway function, turning-on time, headlamp range adjustment, automatic lights when raining, one-touch signalling, travel mode.	»» page 107
	Vehicle interior lighting	Brightness of instrument panel and controls	»» page 114
	Coming Home/Leaving Home function	Switch-on time of the "Coming home" and "Leaving home" functions	»» page 111
Driver assistance	ACC (adaptive cruise control)	Activation and deactivation: default distance level, driving profiles.	»» page 255
	Front Assist (emergency brake assistance system)	Activation and deactivation: Front Assist, advance warning, distance warning display	»» page 251
	Lane Assist (system warning you if you leave the lane)	Activation and deactivation of lane departure warning, adaptive lane guidance	»» page 263
	Detection of traffic signs	Display on the instrument panel, activation and deactivation of the speed warning	»» page 70
	Trailer	Trailer recognition (display of traffic signs for vehicles with trailer), use to calculate the route, maximum speed for trailer	»» page 303
	Fatigue detection	Activation and deactivation	»» page 69
Parking and manoeuvring	ParkPilot	Automatic activation, front volume, front sound treble, rear volume, rear sound treble, adjust Infotainment volume	»» page 291, »» page 294
	Auto Hold	Switching on and off when starting off	»» page 278
	Electric parking brake	Switching on and off automatically	»» page 276
	Braking while manoeuvring function	Switching on and off	»» page 294
	Displaying the parking space	Switching on and off	
Ambient Lighting	-	Switching on and off, selecting brightness, colour, area or total	»» page 114

»

## Operation

Menu	Submenu	Possible setting	Description
Mirrors and wind-screen wipers	Mirrors	Synchronous adjustment, lower the passenger side mirror while reversing (kerb function), fold in after parking, exterior mirrors heating, dim when dark	»» page 117
	Windscreen wipers	Activate and deactivate automatic wipers if raining, rear window wiping in reverse gear	»» page 114
Opening and closing	Electric windows	Convenience opening, automatic closure in case of rain, automatic closure with central locking	»» page 103
	Central locking	Unlocking doors, automatic lock/unlock when driving, "Easy Open" audible confirmation, "Easy Entry" convenient entry function, automatic opening of the rear lid, interior monitoring	»» page 87
Instrument panel	-	Current consumption, average consumption, convenience consumers, ECO Advice, travelling time, distance travelled, average speed, digital speed display, speed warning, oil temperature, coolant temperature, reset data "when setting off", reset data for "total calculation", traffic signal detection	»» page 67
Date and time	-	Time source, time, select time zone, time format, date, date format	»» page 73
Units	-	Distance, speed, temperature, volume, fuel consumption, GNC consumption, electric consumption, pressure	-
Service	-	Vehicle ID number, date of next service inspection, date of next oil change service	»» page 75
Factory settings	All	Restore all settings	-
	Individual	Lights, driver assistance, parking and manoeuvring, background lighting, rear view mirrors and windscreen wipers, opening and closing, instrument panel	-

When the function button check box is activated , the function is active.

Pressing the menu button  will always take you to the last menu used.

Any changes made using the settings menus are automatically saved on closing those menus.

The actual number of menus available and the name of the various options will depend on the vehicle's electronics and equipment.

## Multifunction steering wheel

### Operation of the audio, telephone and navigation system with voice control

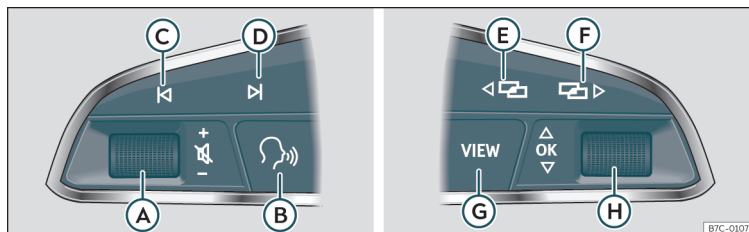

Fig. 65 Controls on the steering wheel.

The steering wheel includes a multifunction module from where it is possible to control

the audio, telephone and radio/navigation functions without needing to distract the driver.

Button	Radio	Media (except AUX)	AUX	Telephone*	Navigation*
Ⓐ Turn	Turn volume up/down.	Turn volume up/down.	Turn volume up/down.	Turn volume up/down.	Turn announcement volume up/down.
Ⓐ Press	Mute volume.	Mute volume.	Mute volume.	Mute incoming call.	Mute voice navigation
Ⓑ <sup>a)</sup>	Enable/disable voice control <sup>b)</sup> . This function can be used from any mode, except in the case of an active call.				
Ⓒ / Ⓓ	Search for the previous/next station <sup>c)</sup> .	<i>Short press:</i> Switch to the previous/next track. <i>Long press:</i> Fast rewind/forward <sup>d)</sup> .	No function	– No active call: Radio/Media functionality (except AUX) – Active call: no function	No function for the other modes (navigation, assistants, vehicle status, travel data).
Ⓔ / Ⓕ <sup>a)</sup>	Change menu on instrument panel. <sup>b)</sup>				



## Operation

Button	Radio	Media (except AUX)	AUX	Telephone*	Navigation*
Ⓞ	<i>Short press</i> <sup>b)</sup> : Change views <b>Classic Info / Digital Maps / Semicircular dials / Sport</b> . <i>Long press</i> <sup>b)</sup> : access the "Personalised Profiles" configuration view.				
Ⓜ Turn	List of sources available (audio/media).	List of sources available (audio/media).	No function	– <i>There is no active call</i> : Recent calls list. – <i>Active call</i> : go to the call options list (call in standby, hang up, mute microphone, private number, etc.).	– <i>Navi System Plus</i> : Zoom in/out (with and without active route). – <i>Navi System</i> : If there is a map on the Digital Scorecard: Zoom in-out (with and without active route). If there is no map on the Digital Scorecard: the map is transferred from the Infotainment System display to the Digital Scorecard (with and without active route).
Ⓜ Press	No function	No function	No function	No function	Auto/Manual Zoom Zoom if the map on the DigitScorecard.

a) According to the vehicle's equipment package.

b) This function can be used from any mode (audio, media, navigation, vehicle status, travel data).

c) This action can be performed when you are listening to the radio; there is no need to be in audio-radio mode.

d) These actions can be performed when you are listening to media; there is no need to be in audio-radio mode.

## Opening and closing

### Set of vehicle keys

#### Vehicle key

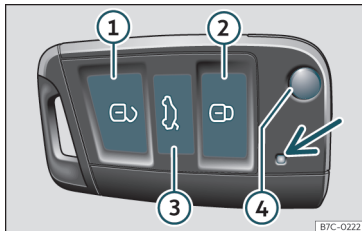

**Fig. 66** Assignment of buttons on the remote control key.

Key to >>> **Fig. 66**

- ① Unlock the vehicle
- ② Lock the vehicle
- ③ Unlock only the rear lid. Press the button until all the turn signals on the vehicle flash briefly. You have 2 minutes to open the rear lid. Once this time has passed, it will lock again. In addition, the lamp on the key flashes.
- ④ Folding the key shaft in and out

With the vehicle key the vehicle may be locked or unlocked remotely >>> page 87.

The vehicle key includes an emitter and battery. The receiver is in the interior of the vehicle. The range of the vehicle key with remote control and new battery is several metres around the vehicle.

If it is not possible to open or close the vehicle using the remote control key, this should be re-synchronised >>> page 87 or the battery changed >>> page 86.

Different keys belonging to the vehicle may be used.

#### Control lamp on the vehicle key

When a button on the vehicle key is pressed, the control lamp flashes >>> **Fig. 66** (arrow) once briefly, but if the button is held down for a longer period the control lamp flashes several times, such as in convenience opening.

If the vehicle key control lamp does not light up when the button is pressed, replace the key's battery >>> page 86.

#### Spare key

To obtain a spare key and other vehicle keys, the vehicle ID number is required.

Each new key contains a microchip which must be coded with the data from the vehicle electronic immobiliser. A vehicle key will not work if it does not contain a microchip or the microchip has not been encoded. This is

also true for keys which are specially cut for the vehicle.

The vehicle keys or new spare keys can be obtained from a specialised CUPRA dealer or SEAT Official Service, a specialised workshop or an approved key service qualified to create this kind of key.

New keys or spare keys must be synchronised before use >>> page 87.

#### **⚠ WARNING**

- Never leave children or disabled persons in the vehicle. In case of emergency, they may not be able to leave the vehicle or manage on their own.
- An uncontrolled use of the key could start the engine or activate any electric equipment (e.g. electric windows), causing risk of accident. The doors can be locked using the remote control key. This could become an obstacle for assistance in an emergency situation.
- Never forget the keys inside the vehicle. An unauthorised use of your vehicle could result in injury, damage or theft. Therefore always take the key with you when you leave the vehicle.
- Never remove the key from the ignition if the vehicle is in motion. Otherwise, the steering could suddenly block and it would be impossible to steer the vehicle.

>>

### ⓘ CAUTION

All of the vehicle keys contain electronic components. Protect them from damage, impacts and humidity.

### ⓘ Note

- Only use the key button when you require the corresponding function. Pushing the button unnecessarily could accidentally unlock the vehicle or trigger the alarm. It is also possible even when you are outside the radius of action.
- Key operation can be greatly influenced by overlapping radio signals close to the vehicle working in the same range of frequencies, for example, radio transmitters or mobile telephones.
- Obstacles between the remote control and the vehicle, bad weather conditions and discharged batteries can considerably reduce the range of the remote control.
- If the buttons of the vehicle key are pressed or one of the central locking buttons »» page 89 is pressed repeatedly in short succession, the central locking briefly disconnects as protection against overloading. The vehicle is then unlocked. Lock it if necessary.
- Spare remote control keys are available at your Technical Service, where they must be matched to the locking system.
- Up to five remote control keys can be used.

### To change the battery

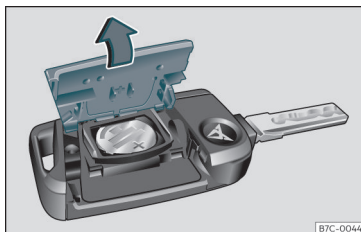

Fig. 67 Vehicle key: opening the battery compartment cover.

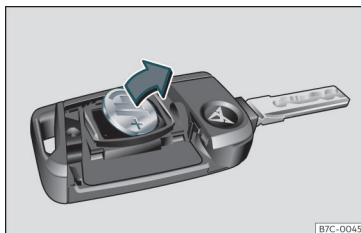

Fig. 68 Vehicle key: removing the battery.

CUPRA recommends you ask a specialised workshop to replace the battery.

The battery is located to the rear of the vehicle key, under a cover.

### Changing the battery

- Unfold the vehicle key blade »» page 85.
- Remove the cover from the back of the vehicle key »» Fig. 67 in the direction of the arrow »» ⓘ.
- Extract the battery from the compartment using a suitable thin object »» Fig. 68.
- Place the new battery in the compartment as shown »» Fig. 68, pressing in the opposite direction to that shown by the arrow »» ⓘ.
- Fit the cover as shown »» Fig. 67, pressing it onto the vehicle key casing in the opposite direction to that shown by the arrow until it clicks into place.

### ⓘ CAUTION

- If the battery is not changed correctly, the vehicle key may be damaged.
- Use of unsuitable batteries may damage the vehicle key. For this reason, always replace the dead battery with another of the same voltage, size and specifications.
- When fitting the battery, check that the polarity is correct.

### ♻️ For the sake of the environment

Please dispose of your used batteries correctly and with respect for the environment.



## Synchronize the vehicle key

If the  button is pressed frequently outside of the vehicle range, it is possible that the vehicle can no longer be locked or unlocked using the key. In this case, the key must be resynchronised as described below:

- Unfold the vehicle key blade >>> page 85.
- If necessary, remove the cover from the driver door lever >>> page 96.
- Press the  button on the vehicle key. For this, it must remain with the vehicle.
- Open the vehicle within one minute using the key blade. The key has been synchronised.
- If necessary, fit the cap.

## Central locking

### Introduction

Central locking functions correctly when all the doors and the rear lid are correctly shut. If the driver door is open, the vehicle *cannot* be locked with the key.

If the vehicle has the Keyless Access locking and ignition system, it may only be locked with the ignition off and the driver's door closed.

The battery of an unlocked vehicle parked for a long period (e.g. in a private garage) may run down and fail to start the motor.

### WARNING

The incorrect use of the central locking system may cause serious injuries.

- The central locking system will lock all doors. A vehicle locked from the inside can prevent any non-authorized individual from opening the doors and accessing the vehicle. Nevertheless, in case of emergency or accident, locked doors will complicate access to the vehicle interior to help the passengers.
  - Never leave children or disabled people alone in the vehicle. The central locking button can be used to lock all the doors from within. Therefore, passengers will be locked inside the vehicle. Individuals locked in the vehicle can be exposed to very high or very low temperatures.
  - Depending on the time of the year, temperatures inside a locked and closed vehicle can be extremely high or extremely low resulting in serious injuries and illness or even death, particularly for young children.
  - Never leave individuals locked in a closed and locked vehicle. In case of emergency, they may not be able to exit the vehicle by themselves or get help.

## Description

Central locking allows all doors, the rear lid and the tank flap to be unlocked centrally:

- From outside, using the vehicle key >>> page 89.
- From outside with the Keyless Access >>> page 90 system,
- From inside, by pushing the central locking button >>> page 89.

Various functions are available to improve the vehicle safety:

- Security system "Safe" >>> page 93
- Self-locking system to prevent involuntary unlocking
- Selective unlocking system
- Automatic speed dependent locking and unlocking system (Auto Lock)
- Emergency unlocking system

### Self-locking system to prevent involuntary unlocking

It is an anti-theft system and prevents the unintentional unlocking of the vehicle. If the vehicle is unlocked and none of the doors (including the boot) are opened within 30 seconds, it re-locks automatically. »

### Unlocking one side of the vehicle only

When you lock the vehicle with the key, the doors and the rear lid are locked. When you open the door, you can either unlock *only* the driver door, or all the vehicle doors. To select the required option, use Easy Connect\* >>> page 88.

### Automatic locking (Auto Lock)\*

The Auto Lock function locks the doors and the rear lid when the vehicle exceeds a speed of about 15 km/h (9 mph).

The vehicle is unlocked again when the ignition key is removed. Alternatively, the vehicle can also be unlocked via the central locking switch or by pulling one of the inside door handles.

The Auto Lock function can be activated and deactivated in the Easy Connect\* >>> page 88 system.

In the event of an accident in which the airbags inflate, the doors will be automatically unlocked to facilitate access and assistance.

### Turn signals

The turn signals will flash twice when the vehicle is unlocked and once when the vehicle is locked.

If it does not flash, this indicates that one of the doors, the rear lid or the bonnet is not closed correctly.

### Accidental lock-out

The central locking system prevents you from being locked out of the vehicle in the following situations:

- If the driver door is open, the vehicle cannot be locked with the central locking switch >>> page 89.

Lock the vehicle with the remote control key, when all the doors and the rear lid have been closed. This prevents the accidental locking of the vehicle.

#### Note

- **Never leave any valuable items in the vehicle unattended. Even a locked vehicle is not a safe.**
- **If the LED on the driver door sill lights up for about 30 seconds when the vehicle is locked, the central locking system or anti-theft alarm\* is not working properly. You should have the fault repaired at a specialised CUPRA dealer, SEAT Official Service or specialised workshop.**
- **The vehicle interior monitoring of the anti-theft alarm\* system will only function as intended if the windows and the sunroof\* are closed.**

### Central locking settings

Central locking settings can be changed in the Easy Connect\* system.

#### Unlocking doors

- Select: button  > **SETTINGS** > **Opening and closing** > **Central locking** > **Unlocking the doors**.

You can choose to unlock **all** the doors or only the **driver door** when you unlock the vehicle. In all the options, the fuel tank flap is also unlocked.

With the **Driver** setting, when you press the  button on the remote control key once, only the driver door is unlocked. If that button is pressed twice, the rest of the doors and the rear lid will be unlocked.

If the  button is pressed, all the vehicle doors are locked. At the same time, a confirmation signal\* is heard.

#### Automatic locking (Auto Lock)

- Select: button  > **SETTINGS** > **Opening and closing** > **Central locking** > **Automatic locking**.

If the function is activated, all the vehicle doors are locked at speeds above 15 km/h (9 mph).

The doors unlock automatically when the key is removed from the ignition. In addition, you can unlock the doors by pressing central locking key  >>> page 89 or, individually, by operating the internal door handle (e.g. so that a passenger can get out).

### Unlock and lock from the outside

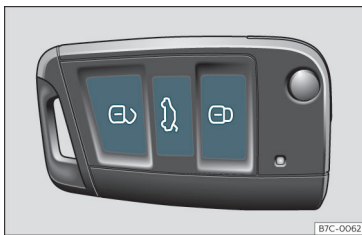







Fig. 69 Remote control key: buttons.

- Lock: press the  >>> Fig. 69 button.
- Locking the vehicle without the "Safe" security system: push the  button again and hold for 2 seconds.
- Unlock: press the  button.
- Unlocking the rear lid: hold down the  button for at least 1 second.

The vehicle will be locked again automatically if you do not open one of the doors or the rear lid within 30 seconds after unlocking the

car. This function prevents the vehicle from remaining unlocked if the unlocking button is pressed by mistake. This does not apply if you press the  button for at least one second.

### Selective unlocking system

The selective unlocking system allows you to only unlock the driver door and the fuel tank flap. All other doors and the rear lid remain locked.

*Unlocking the driver's door and tank flap:*

- Press (once) the  button on the remote control key or turn the key *once* in the opening direction.

*Unlocking all the doors, the rear lid and the tank flap simultaneously:*

- Within 5 seconds, press (twice) the  button on the remote control key, or turn the key *twice* within 5 seconds in the opening direction.

The Safe\* security system and the anti-theft alarm\* deactivate immediately when only the driver door is opened.

In vehicles with Easy Connect\*, you can programme the security central locking system directly >>> page 88.

### WARNING

Observe the safety warnings >>>  in Locking system "Safe" on page 93.



### Note

- Do not use the remote control key until the vehicle is visible.
- Other functions of the remote control key >>> page 103, Convenience open/close function.

### Unlocking and locking from the inside



Fig. 70 Driver's door: central locking switch.

- Lock: press the  >>> Fig. 70 button.
- Unlock: press the  >>> Fig. 70 button.

Please note the following when using the central locking switch to lock your vehicle: >>

- It is not possible to open the doors or the rear lid from the *outside* (for safety reasons, e.g. when stopped at traffic lights).
- The LED in the central locking switch lights up when all the doors are closed and locked.
- You can open the doors individually from the inside by pulling the inside door handle.
- In the event of an accident in which the airbags inflate, doors locked from the inside will be automatically unlocked to facilitate access and assistance.

### ⚠ WARNING

- The central locking switch also works with the ignition switched off, except when the “safe” system is activated.
- The central locking switch does not operate if the vehicle is locked from the outside and the security system is switched on.
- Locked doors could delay assistance in an emergency. Do not leave anyone, especially children, in the vehicle.

### 📄 Note

Your vehicle will lock automatically when it reaches a speed of about 15 km/h (9 mph) (Auto Lock) >>> page 87. You can unlock the vehicle again using the  button on the central locking switch.

### Unlock and lock the vehicle with Keyless Access\*

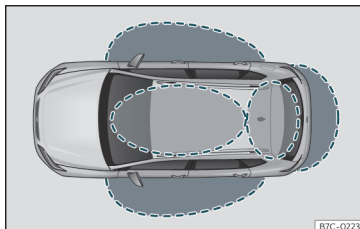

Fig. 71 Keyless Access: proximity zones.

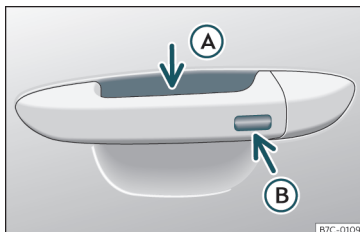



Fig. 72 Keyless Access locking and ignition system

Depending on the equipment, the vehicle may have the Keyless Access system.

Keyless Access is a key-free locking and ignition system to unlock and lock the vehicle without actively using its key. To do this, all that is required is to have a valid vehicle key

in the detection area where you are attempting to access the vehicle >>> Fig. 71 and to touch one of the sensor surfaces on the door handles >>> Fig. 72 or operate the *softtouch*/handle on the rear lid >>> page 98 >>> .

The vehicle can be unlocked and locked via the front doors only. When doing so, the remote control key must be no further than approx. 1.5 m away from the door handle.

It does not matter where you carry the key, e.g. in your jacket pocket.

Once the doors have been locked, they cannot be opened again immediately. This will enable you to check that the doors are properly closed.

If you wish you may unlock *only* the corresponding door or the entire vehicle. The necessary adjustments can be performed in vehicles with a driver information system >>> page 80.

### General information

If a valid key is in the proximity of the car, >>> Fig. 71 the Keyless Access locking and starting system gives the key entry as soon as one of the sensor surfaces on the door handles is touched or the *softtouch*/handle on the rear lid is operated. The following features are then available without having to use the vehicle key actively:

- **Keyless Entry:** unlocking the vehicle using the handles of the front doors or the *soft-touch/handle* on the rear lid.
- **Keyless Exit:** locking the vehicle using the sensor of the driver or passenger door handle.
- **Easy Open:** opening the rear lid moving one foot below the rear bumper >>> page 100.
- **Press & Drive:** keyless starting of the engine with the starter button >>> page 226.

The central locking and locking systems operate in the same way as a *normal* locking and unlocking system. Only the controls change.

Unlocking the vehicle is confirmed with a *double* flash of the indicator lights; locking by a *single* flash.

If the vehicle is locked and then all doors and the rear lid are closed leaving the last key used inside the vehicle and none outside, the vehicle will **not** lock **immediately**. All the vehicle's indicator lights will flash *four times*. The vehicle will lock after a few seconds if you do not open any door or the rear lid.

The vehicle will lock again after a few seconds if you unlock the vehicle but fail to open any door or boot hatch.

### Unlocking and opening the doors (Keyless-Entry)

- Grip one of the front door handles. When you do this, you touch the sensor surface >>> Fig. 72 (A) (arrow) of the handle and the vehicle unlocks.
- Open the door.

On vehicles with selective opening or information system configuration, pulling the door handle twice will unlock all doors.

### In vehicles without the "Safe" security system: closing and locking the doors (Keyless-Exit)

- Switch the ignition off.
- Close the driver's door.
- Touch (*once*) the locking sensor surface >>> Fig. 72 (B) (arrow) on one of the front door handles. The door that is used must be closed.

### In vehicles with the "Safe" security system: closing and locking the doors (Keyless-Exit)

- Switch the ignition off.
- Close the driver's door.
- Touch (*once*) the sensor surface >>> Fig. 72 (B) (arrow) on one of the front door handles. The vehicle locks with the "Safe" security system >>> page 93. The door that is used must be closed.

- Touch (*twice*) the sensor surface >>> Fig. 72 (B) (arrow) of one of the front door handles to lock the vehicle without activating the "Safelock" security system >>> page 93.

### Unlocking and locking the boot hatch

When the vehicle is locked, the rear lid automatically unlocks on opening if there is a valid vehicle key in the proximity >>> Fig. 71.

Open or close the rear lid *normally*.

After closing, the hatch locks automatically. If the complete vehicle is unlocked, the rear lid will **not** lock automatically after closing it.

### What happens when locking the vehicle with a second key

If there is a vehicle key inside the vehicle and it is locked from the outside with a second vehicle key, the key inside the vehicle is blocked for engine ignition >>> page 226. In order to enable engine ignition, press the  button on the key inside the vehicle.

### Automatically disabling sensors

If the vehicle is not locked or unlocked for a long period of time, the proximity sensors on the passenger doors are automatically disabled.

If one of the sensor surfaces on the door handles is often activated in an unusual manner with the vehicle locked (e.g. by the >>>

branches of a bush rubbing against it), all proximity sensors are disabled for a certain period of time.

Sensors will again be enabled:

- After a time.
- **OR:** if the vehicle is unlocked with the button  on the key.
- **OR:** if the boot is opened.
- **OR:** if the vehicle is unlocked manually with the key.

### Keyless Access temporary disconnection function\*

You can deactivate the vehicle's Keyless Access unlocking for one locking and unlocking cycle.

- Move the gear lever to position **P** (if the vehicle has automatic gearbox), since otherwise the vehicle cannot be locked.
- Close the door.
- Push the central locking button  on the remote control and touch the locking sensor surface of the driver door handle >>> **Fig. 72 B** within the following 5 seconds. Do not grasp the door handle; otherwise the vehicle will not unlock. Deactivation is also possible if the vehicle is locked through the driver's door lock.
- To check that the function has been deactivated, wait at least 10 seconds, grip and pull

on the door handle. The door should not open.

The next time the door can only be unlocked via the remote control or the lock cylinder. The next time the door is locked/unlocked, Keyless Access will be active again.

### Convenience functions

To close all the electric windows and the sunroof using the **comfort function**, keep a finger for a few seconds on the locking sensor surface >>> **Fig. 72 B** (arrow) of the door handle until the windows and roof have closed.

How the **doors open** when touching the sensor surface on the door handle will depend on the settings that have been activated in the infotainment system, using the button  > **SETTINGS > Opening and closing**.

### ⓘ CAUTION

The sensor surfaces on the door handles could engage if hit with a water jet or high pressure steam if there is a valid vehicle key in the proximity. If at least one of the electric windows is open and the sensor surface >>> **Fig. 72 B** (arrow) on one of the handles is activated continuously, all windows will close.

### ⓘ Note

- If the vehicle battery has little or no charge, or the vehicle key battery is almost or entirely out of charge, you will probably not be able to lock or unlock the vehicle with the Keyless Access system. The vehicle can be unlocked or locked manually >>> page 96.
- To control the proper locking of the vehicle, the release function is disabled for approx. 2 seconds.
- If the message **Keyless access system fault** is displayed on the screen of the dash panel, abnormalities may occur in the operation of the Keyless Access system. Contact a specialised workshop. To do so, CUPRA recommends going to a specialised CUPRA dealer or any SEAT dealership.
- Depending on the function set on the infotainment system for the mirrors, the exterior mirrors will unfold and the surround lighting will come on when unlocking the vehicle using the sensor surface on the driver and passenger door handles >>> page 117.
- If there is no valid key inside the vehicle or the system fails to detect one, a warning will display on the dash panel screen. This could happen if any other radio frequency signal interferes with the key signal (e.g. from a mobile device accessory) or if the key is covered by another object (e.g. an aluminium case).

- If the sensors are very dirty, e.g. have a layer of salt, the correct functioning of the sensors on the door handles may be affected. In this case, clean the vehicle.
- If the vehicle is equipped with an automatic gearbox, it may only be locked in the gear stick is in position P.
- To improve the safety of your vehicle, the remote control of the system is equipped with a position sensor. If this remote control does not detect movement for a certain length of time, the system will conclude that the vehicle cannot be opened (e.g. on a night table) so it will be disabled.

### Locking system “Safe”<sup>1)</sup>



When the vehicle is locked, the “Safe” security system puts the door handles out of operation and makes it difficult for unauthorized people to enter. The doors cannot be opened from inside >>> .

Depending on the vehicle, when switching the ignition off, a warning may be displayed on the control panel screen stating that the “Safe” security system is activated.

Lock the vehicle and activate the “Safe” security system.

- Press the locking button  once on the vehicle key.

Lock the vehicle without activating the “Safe” system.

- Press the locking  button on the vehicle key *twice*.
- **OR:** touch the sensor surface on the outside of the door handle *twice* >>> Fig. 72 

When the “Safe” security system is disabled, the following needs to be taken into account:

- The vehicle can be opened and unlocked from the inside using an inside door handle.
- The anti-theft alarm is activated.
- The vehicle interior monitoring system and the anti-tow system are disabled.

#### “Safe” status

The flashing frequency of the diode in the door sill immediately confirms the process. Initially, the diode flashes in a fast sequence for a brief period, then it stops for approximately 30 seconds and, lastly continues flashing slowly.

### WARNING

Do not leave anyone (especially children) in the vehicle if it is locked from the outside and the “Safe” security system\* is activated, as the doors and windows cannot then be opened from the inside. Locked doors could delay assistance in an emergency.

## Anti-theft alarm system\*

### Description

The anti-theft alarm makes it more difficult to break into the vehicle or steal it. The system will initiate acoustic and optical warning signals when your vehicle is tried to be forced.

The anti-theft alarm is automatically turned on when the vehicle is locked with the key. The system is immediately activated and the turn signal light located on the driver door will flash along with the turn signals, indicating that the alarm and the locking security system (double lock) have been turned on.

If any of the doors or the bonnet are open, they will not be included in the protection zones of the vehicle when the alarm is connected. If the door or the bonnet are

»

<sup>1)</sup> Available depending on market and version.

subsequently closed, they will be automatically included in the protection areas of the vehicle and the turn signals will flash accordingly when the doors close.

- The turn signal light will flash twice on opening and deactivating the alarm.
- The turn signal light will flash once on closing and activating the alarm.

### When does the system trigger an alarm?

The anti-theft alarm siren will be triggered for about 30 seconds alongside a sound and optical (flashing) warning signals and will be repeated about ten times when the vehicle is locked and the following unauthorised actions are attempted:

- Opening a door that is mechanically unlocked using the vehicle key without switching on the ignition in the next 15 seconds (in certain markets, such as the Netherlands, there is no 15 second waiting time and the alarm is activated immediately on opening the door).
- A door is opened.
- Opening the bonnet.
- The rear lid is opened.
- When the ignition is switched on with a non-authorized key.
- Undue manipulation of the alarm.
- Disconnection of the vehicle battery.

- Movement inside the vehicle (in vehicles with interior monitoring >>> page 95).
- When the vehicle is towed (in vehicles with anti-tow system >>> page 95).
- When the vehicle is raised (in vehicles with anti-tow system >>> page 95).
- When the vehicle is transported on a ferry or by rail (vehicles with an anti-tow system or vehicle interior monitoring >>> page 95).
- When a trailer connected to the anti-theft alarm system is disconnected.

### How to turn OFF the alarm

- Unlock the vehicle with the unlock button  of the key.
- **OR:** turn the ignition on with a valid key.

If the driver's door is unlocked mechanically using the key, the key must be inserted into the ignition, and the ignition must be turned on within 15 seconds of opening the door.

Otherwise, the alarm will trigger for 30 sec. and the ignition will be blocked.

### CAUTION

If the anti-theft security system is switched off, the vehicle interior monitoring and the tow-away protection are automatically disconnected.

### Note

- After 28 days, the indicator light will be switched off to prevent the battery from exhausting if the vehicle has been left parked for a long period of time. The alarm system remains activated.
- If, after the audible warning goes off, another monitored area is accessed (e.g. the rear lid is opened after a door has been opened), the alarm is triggered again.
- The anti-theft alarm is not activated when the vehicle is locked from within using the central locking button .
- If the driver door is unlocked mechanically with the key, only the driver door is unlocked, the rest of the doors remain locked. Only when the ignition has been turned on will the other doors be available - but not unlocked - and the central locking button will be activated.
- If the vehicle battery is run down or flat then the anti-theft alarm will not operate correctly.
- Vehicle monitoring remains active even if the battery is disconnected or not working for any reason.
- The alarm is triggered immediately if one of the battery cables is disconnected while the alarm system is active.



### Interior monitoring and the anti-tow system\*

It is a monitoring or control function incorporated in the anti-theft alarm\* which detects unauthorised vehicle entry by means of ultrasound.



The vehicle interior monitoring and anti-tow sensor (tilt sensor) are automatically switched on when the anti-theft alarm is switched on. In order to activate it, all the doors and the rear lid must be closed.

If the "Safe" security system\* >>> page 93 is switched off, the vehicle interior monitoring and the tow-away protection are automatically disconnected.

#### Activation

- It is automatically switched on when the anti-theft alarm is activated.

#### Deactivation

- Open the vehicle with the key, either mechanically or by pressing the  button on the remote control. The time period from when the door is opened until the key is inserted in the contact should not exceed 15 seconds, otherwise the alarm will be triggered.
- Press the  button on the remote control twice. The volumetric sensor and tilt sensors will be deactivated. The alarm system remains activated.

The vehicle interior monitoring and the anti-tow system are automatically switched on again next time the vehicle is locked.

If you wish to switch off the vehicle interior monitoring and the anti-tow system, it must be done each time that the vehicle is locked; if not, they will be automatically switched on.

The vehicle interior monitoring and the anti-tow system should be switched off if animals are left inside the locked vehicle (otherwise, their movements will trigger the alarm) or when, for example, the vehicle is transported or has to be towed with only one axle on the ground.

#### Deactivation through the infotainment system

- Turn off the ignition and select: button  > **SETTINGS > Opening and closing > Central locking > Interior monitoring.**
- When the vehicle is locked now, the vehicle interior monitoring and the tow-away protection are switched off until the next time the door is opened.

#### False alarms

Interior monitoring will only operate correctly if the vehicle is completely closed. Please observe related legal requirements.

#### The following cases may cause a false alarm:

- Open windows (partially or fully).
- Panoramic/tilting sunroof open (partially or completely).
- Movement of objects inside the vehicle, such as loose papers, items hanging from the rear vision mirror (air fresheners), etc.

#### Note

- If the vehicle is relocked and the alarm is activated without the volumetric sensor function, relocking will activate the alarm with all its functions, except the volumetric sensor. This function is reactivated when the alarm is switched on again, unless it is deliberately switched off.
- If the alarm has been triggered by the volumetric sensor, this will be indicated by a flashing of the warning lamp on the driver door when the vehicle is opened. The flash is different to the flash indicating the alarm is activated.
- The vibration of a mobile phone left inside the vehicle may cause the vehicle interior monitoring alarm to trigger, as both sensors react to movements and shakes inside the vehicle.
- If on activating the alarm, any door or the rear lid is open, only the alarm will be activated. The vehicle interior monitoring and the anti-tow system will only be activated »

once all the doors are closed (including the rear lid).

## Doors

### Introduction

The doors and rear lid can be locked manually and partially opened, for example if the key or the central locking is damaged.

#### **⚠ WARNING**

Opening and closing doors carelessly can cause serious injury.

- If the vehicle is locked from outside, the doors and windows cannot be opened from the inside.
- Never leave children or disabled people alone in the car. They could be trapped in the car in an emergency and will not be able to get themselves to safety.
- Depending on the time of the year, temperatures inside a locked and closed vehicle can be extremely high or extremely low resulting in serious injuries and illness or even death, particularly for young children.

#### **⚠ WARNING**

Getting in the way of the doors and the rear lid is dangerous and can lead to serious injury.

- Open and close the doors and the rear lid only when there is nobody in the way.

#### **ⓘ CAUTION**

When opening and closing in an emergency, carefully disassemble components and then reassemble them carefully to avoid damage to the vehicle.

### Emergency unlocking or locking of the driver's door

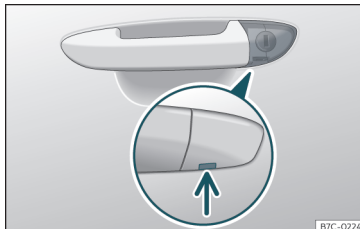

**Fig. 73** Driver door handle: Concealed lock cylinder.

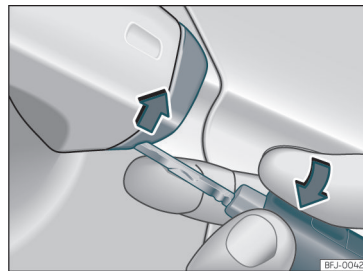

**Fig. 74** Driver door handle: lever the cover off

If the central locking system should fail to operate, the driver door can still be locked and unlocked by turning the key in the lock.

As a general rule, when the driver door is locked manually all other doors are locked. When it is unlocked manually, only the driver door opens. Please observe the instructions relating to the anti-theft alarm system >>> page 93.

- Unfold the vehicle key blade >>> page 85.
- Insert the key shaft into the lower opening in the cover on the driver door handle >>> **Fig. 74** then remove the cover upwards.
- Insert the key blade into the lock cylinder to unlock or lock the vehicle.

### Special characteristics

- The anti-theft alarm will remain active when vehicles are unlocked. However, the alarm will not be triggered >>> page 93.
- After the driver door is opened, you have 15 seconds to switch on the ignition. Once this time has elapsed, the alarm is triggered.
- Switch the ignition on. The electronic immobilizer recognises a valid vehicle key and deactivates the anti-theft alarm system.

#### Note

The anti-theft alarm is not activated when the vehicle is locked manually using the key shaft >>> page 87.

### Emergency lock of doors without lock cylinders



Fig. 75 Locking the door manually.

If the central locking system should fail to work at any time, doors with no lock cylinder will have to be locked separately.

The emergency lock is located on the front of the front passenger's door and the rear doors. It can only be seen if the door is open.

- Pull the cap out of the opening.
- Insert the key in the inside slot and turn it to the right as far as it will go (if the door is on the right side) or to the left (if the door is on the left side).
- Replace the cap.

Once the door has been closed it can no longer be opened from the outside. Pull the interior door handle once to unlock and open the door.

### Childproof locks



Fig. 76 Childproof lock on the left hand side door.

The childproof lock prevents the rear doors from being opened from the inside. This system prevents minors from opening a door accidentally while the vehicle is running.

This function is independent of the vehicle electronic opening and locking systems. It only affects rear doors. It can only be activated and deactivated manually, as described below:

#### Activating the childproof lock

- Unlock the vehicle and open the door in which you wish to activate the childproof lock.
- With the door open, rotate the groove in the door using the ignition key, clockwise for the left hand side doors >>> Fig. 76 and anti-clockwise for the right hand side doors.

#### Deactivating the childproof lock

- Unlock the vehicle and open the door whose childproof lock you want to deactivate.
- With the door open, rotate the groove in the door using the ignition key, anti-clockwise for the left hand side doors >>> Fig. 76 and clockwise for the right hand side doors.

Once the childproof lock is activated, the door can only be opened from the outside.

## Rear lid

### Introduction

#### **⚠ WARNING**

Careless and unsuitable locking, opening and closing of the rear lid can cause accidents and serious injury.

- The rear lid must not be opened when the reverse or rear fog lights are lit. This may damage the tail lights.
- Do not close the rear lid by pushing it down with your hand on the rear window. The glass could smash. Risk of injury!
- Ensure the rear lid is locked after closing it. If not, it may open unexpectedly while driving.
- Closing the rear lid without observing and ensuring it is clear could cause serious injury to you and to third parties. Make sure that no one is in the path of the rear lid.
- Never drive with the rear lid open or half-closed, exhaust gases may penetrate into the interior of the vehicle. Danger of poisoning!
- Never leave the vehicle unattended or allow children to play inside or next to it, especially if the rear lid is open. Children could enter the luggage compartment, close the rear lid and become trapped. A locked vehicle can reach extremely high and low temperatures, depending on the

time of year, thus causing serious injuries, illness or even death.

#### **⚠ CAUTION**

Before opening or closing the rear lid, make sure that there is enough space to open or close it, e.g. when pulling a trailer or in a garage.

#### **i Note**

Before closing the rear lid, make sure that the key has not been left inside the luggage compartment.

### Opening and closing the rear lid

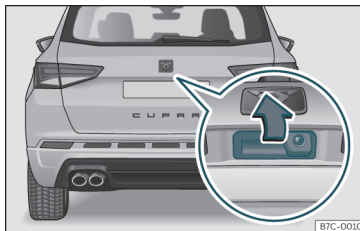



Fig. 77 Rear lid: handle

The rear lid opening system operates electrically. It is activated by exerting slight pressure on the handle » Fig. 77.

To lock or unlock the rear lid, press the  or  buttons of the vehicle key.

A warning appears on the instrument panel display if the rear lid is open or not properly closed.\* An audible warning is also given if it is opened while the vehicle is moving faster than 6 km/h (4 mph)\*.

#### Opening and closing

- To open: place slight pressure on the handle. The rear lid opens automatically.
- To close: hold one of the handles on the inner trim and close it by moving it downwards, or press the button on the rear lid\* » Fig. 78.

If the doors are locked, the rear lid is also locked.

### Rear lid with electric opening and closing\*

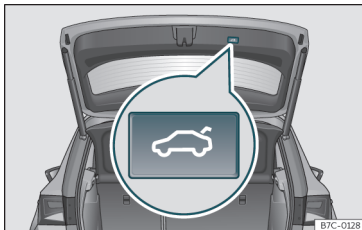

Fig. 78 Rear lid: button to close the rear lid.



Fig. 79 Centre console: button to open and close the rear lid.





#### Opening the rear lid

- Unlock the vehicle >>> page 87 and briefly press the handle of the rear lid. On vehicles with Keyless Access you can directly press the handle of the rear lid. The rear lid is un-

locked if an authorised key is recognised in the proximity of the vehicle.

- **OR:** press the button on the centre console for at least one second >>> Fig. 79. The button also works when the ignition is switched off.
- **OR:** press and hold the  button of the vehicle key for approx. 1 second. If the vehicle is locked, only the rear lid is unlocked (the doors remain locked).
- **OR:** on vehicles with Keyless Access and sensor-controlled opening you can open the rear lid by moving one foot in the area of the sensors located below the rear bumper (Easy Open >>> page 100). The rear lid will be automatically opened.

#### Closing the rear lid

- Briefly press the  button on the rear lid >>> Fig. 78 >>>  in Introduction on page 98.
- **OR:** press the  button located on the centre console until the rear lid is closed >>> Fig. 79.
- **OR:** on vehicles with Keyless Access, press and hold the  vehicle key button until the rear lid is closed, or move one foot into the area of the sensors located below the rear bumper (Easy Open) >>> page 100. The key of the vehicle must not be further away than 1.5 m from the boot or inside the vehicle.

- **OR:** manually move the rear lid in the direction of closing until it closes automatically.
- The rear lid goes down automatically to the final position and also closes automatically >>>  in Introduction on page 98.

#### Interrupting opening or closing

After beginning to open or close the rear lid, the action can be halted by pressing one of the  buttons.

Continue opening or closing the rear lid by hand. To do this, some force will have to be used.

If you press one of the  buttons again, the rear lid will move again in the original direction.

If the rear lid is met with resistance or an obstacle during the automatic opening or closing, opening or closing will be interrupted immediately. For the closing process, the rear lid opens again slightly.

- Check why it has not been possible to open or close the rear lid.
- Try to open or close the rear lid again.
- If necessary, the rear lid can be opened or closed by hand using reasonable force. >>>

### Particular features if towing a trailer

If the factory-fitted towing bracket is electrically connected to a trailer »» page 303, the electric rear lid can only be opened or closed with the buttons on the rear lid itself.

### Acoustic warnings

Throughout the process of opening or closing the rear lid, acoustic warnings can be heard. Exception: when the rear lid is opened manually using the handle or the Easy Open function with the movement of the foot or closed using the button on the rear lid itself »» Fig. 78.

### Modifying and memorising the opening angle

If the space behind or above the vehicle is less than the travel area of the rear lid, you can change the opening angle of the rear lid.

To memorise a new opening angle, the rear lid must be open at least halfway.

- Interrupt the opening process in the desired position.
- Press the  button »» Fig. 78 on the rear lid for at least 3 seconds.

The opening angle is memorised. Memorisation is indicated by blinking of the hazard warning lights and an audible warning.

### Resetting and memorising the opening angle

For the rear lid to reopen completely, the opening angle must be reset and memorised again.

- Release the rear lid and open it to the memorised height.
- Lift the rear lid by hand as far as it goes. To do this, some force will have to be used.
- Press the  button »» Fig. 78 on the rear lid for at least 3 seconds.
- This resets and memorises the factory-set opening angle. Memorisation is indicated by blinking of the hazard warning lights and an audible warning.

### Automatic protection against overheating

If the system is operated repeatedly in a short space of time, it automatically switches off to prevent overheating.

Once the system is cool again, the function can be reused. Until then, the rear lid can only be opened and closed by hand using reasonable force.

If with the rear lid open the vehicle battery is disconnected »» page 326 or the corresponding fuse burns out »» page 52, the system will have to be reset. This requires closing the rear lid completely once.

### Emergency unlocking

»» page 102

#### WARNING

If a lot of snow builds up on the rear lid or it is heavily loaded, the rear lid may not open or, after opening, it may lower by itself due to the extra weight and cause serious injury.

- Do not open the rear lid when there is a lot of snow on it or when carrying a load (e.g. on a rack).
- Before opening the rear lid, remove the snow or the load.

### Rear lid with sensor-controlled opening and closing (Easy Open)



Fig. 80 Rear lid with sensor-controlled opening (Easy Open).

If there is a valid vehicle key in the proximity of the rear lid, it is possible to unlock and open or close it moving one foot in the area of the sensors located under the rear bumper.

- Switch the ignition off.
- Stand in front of the rear bumper, in the middle.
- With a brisk movement, bring your foot and lower leg as close as you can to the bumper. The lower part of the leg needs to be close to the upper sensor area and your foot must be close to the lower sensor area >>> **Fig. 80 ①**.
- Quickly remove your foot and lower leg from the sensor areas >>> **Fig. 80 ②**. The rear lid will be automatically opened.
- If the rear lid fails to open, repeat the procedure after a few seconds.

The third brake light flashes once to show the boot has opened with the Easy Open function.

The rear lid can be closed with another foot movement similar to the opening one (provided a valid vehicle key is in the proximity of the rear lid).

When closed, the rear lid automatically locks if the vehicle has been locked beforehand and there is no valid key inside.

While the rear lid is in motion (either opening or closing), it can be stopped with another foot movement similar to the opening one (provided a valid vehicle key is in the proximity of the rear lid).

The Easy Open feature is not available or only has limited availability in the following situations (examples):

- If the rear bumper is very dirty.
- If the rear bumper is wet with salt water, e.g. after having driven on gritted roads.
- If the electrical unlocking tow hitch is not covered.
- If the vehicle has been equipped at a later time with a tow bracket.

In the event of heavy rain, the Easy Open feature may take a little longer to open the boot or may deactivate automatically, to avoid the boot opening by accident, e.g. because of the running water.

The Easy Open function can be connected and disconnected permanently in the infotainment system using the button  > **SETTINGS > Opening and closing** >>> page 80.

### **WARNING**

If there is a valid key in the proximity of the rear lid, in some cases the Easy Open function may be accidentally activated and the

rear lid will open, for example, when sweeping under the rear bumper, when directing a water jet or high pressure steam to the area or when carrying out maintenance work or repairs in that area. If accidentally opened, the rear lid could injure somebody situated in its area of operation or cause material damage.

- Therefore, always make sure that there is no unsupervised valid key in the area near the rear lid.
- Before carrying out any maintenance or repair work on the vehicle, always disable the Easy Open feature via the infotainment system.
- Before washing the vehicle, always disable the Easy Open feature via the infotainment system.
- Before attaching a bicycle rack or a trailer, >>> page 303, always disable the Easy Open feature via the infotainment system.

## Emergency unlocking of the rear lid

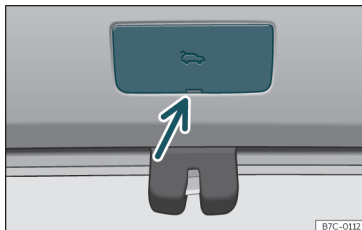

**Fig. 81** Detail of the luggage compartment: access to emergency unlocking.

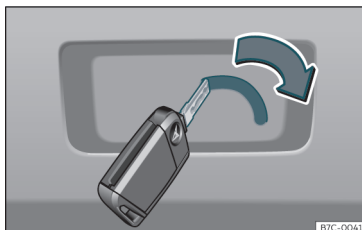

**Fig. 82** Detail of the luggage compartment: emergency unlocking

The rear lid can be unlocked from inside in the event of an emergency (e.g. no battery).

There is a groove in the luggage compartment allowing access to the emergency opening mechanism.

## Unlocking the rear lid from inside the luggage compartment

- Remove the cover using the key blade as a lever >>> **Fig. 81**.
- Insert the key blade into the slot and move the key in the direction of the arrow until the lock unlocks >>> **Fig. 82**.

## Window controls

### Electrically opening and closing the windows

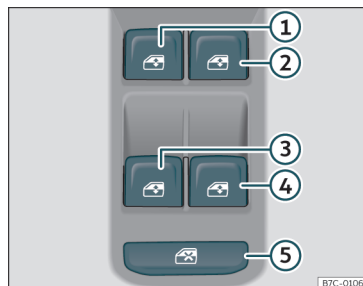

**Fig. 83** Detail of the driver's door: window controls.

- Opening the window: press the button
- Closing the window: pull the button

## Buttons on the driver door

- ① Window on the front left door
- ② Window on the front right door
- ③ Window on the rear left door
- ④ Window on the rear right door
- ⑤ Safety switch for deactivating the electric window buttons in the rear doors.

The front and rear electric windows can be operated by using the controls on the driver door. The other doors each have a switch for their own window.

Always close the windows fully if you park the vehicle or leave it unattended >>> .

You can use the electric windows for approx. 10 minutes after switching off the ignition if neither the driver door nor the front passenger door has been opened and the key has not been removed from the ignition.

### Safety switch

The safety control >>> **Fig. 83** ⑤ on the driver door can be used to disable the electric window buttons on the rear doors.

*Safety switch not pressed:* buttons on rear doors are activated.

*Safety switch pressed:* buttons on rear doors are deactivated.





The safety control symbol  lights up in yellow if the buttons on the rear doors are switched off.



### Convenience open/close function

The electric windows can be opened or closed from outside using the vehicle key:

*Convenience opening:*

- Press and hold the  button on the remote control key until all the windows and the sunroof\* have reached the desired position.
- **OR:** First unlock the vehicle using the  button on the remote control key and then keep the key in the driver door lock until all the windows and the sunroof\* have reached the required position.

*Convenience closing:*

- Press and hold button  on the remote control key until all the windows and the sunroof\* are closed >>> .
- **OR:** Keep the key in the driver door in the "lock" position until all the windows and the sunroof\* are closed.

During convenience closing, first the windows and then the sliding sunroof will be closed.

Different settings can be changed using the Easy Connect system. Select: button  > **SETTINGS > Opening and closing >**

### Electric windows > Convenience opening.

#### One-touch opening and closing

The one-touch automatic opening and closing is used to open or close the windows completely. It will not be necessary to hold the button of the corresponding electric window.

**For the automatic raising function:** pull the button for the corresponding window upwards until it reaches the second position.

**For the automatic lowering function:** pull the button for the corresponding window upwards until it reaches the second position.

**Stop automatic movement:** push or pull on the button of the corresponding window.

#### Resetting one-touch opening and closing

The one-touch opening and closing function is not active after the vehicle battery has been disconnected or is flat and will have to be reset.

- Pull the button of the corresponding window and hold it for one second in this position.
- Release the button and pull upwards and hold again. The one-touch function is now ready for operation.

The automatic one-touch electric windows can be reinitialised individually or several at a time.

### WARNING

Observe the safety warnings >>>  in Introduction on page 96.

- **Incorrect use of the electric windows can result in injury.**
- **Never close the rear lid without observing and ensuring it is clear, to do otherwise could cause serious injury to you and third parties. Make sure that no one is in the path of a window.**
- **If the ignition is switched on, the electric equipment could be activated with risk of injury, for example, in the electric windows.**
- **The doors can be locked using the remote control key. This could become an obstacle for assistance in an emergency situation.**
- **Therefore always take the key with you when you leave the vehicle.**
- **The electric windows will work until the ignition has been switched off and one of the front doors has been opened.**
- **If necessary, use the safety switch to disable the rear electric windows. Make sure that they have been disabled.**
- **For safety reasons, you should only use the remote control open and close functions within about 2 metres of the vehicle. To avoid injuries, always keep an eye on the** »

windows when pressing the button to close them. The windows stop moving as soon as the button is released.

### Note

If the window is not able to close because it is stiff or because of an obstruction, the window will automatically open again >>> page 104. If this happens, check why the window could not be closed before attempting to close it again.

### Window anti-trap function

The roll-back function reduces the risk of injury when the electric windows close.

- If a window is obstructed when closing automatically, the window stops at this point and lowers immediately >>> .
- Next, check why the window does not close before attempting to again.
- If you try within the following 10 seconds and the window closes again with difficulty or there is an obstruction, the automatic closing will stop working for 10 seconds.
- If the window is still obstructed, the window will stop at this point.
- If there is no obvious reason why the window cannot be closed, try to close it again by pulling the tab within ten seconds. The win-

dow closes with maximum force. The roll-back function is now deactivated.

- If more than 10 seconds pass, the window will open fully when you operate one of the buttons. One-touch closing is reactivated.

### WARNING

Observe the safety warnings >>>  in Electrically opening and closing the windows on page 103.

- The roll-back function does not prevent fingers or other parts of the body getting pinched against the window frame. Risk of accident.

## Sunroof\*

### Introduction

The sunroof consists of two glass parts. The rear part is fixed and cannot be opened. It also has a sun blind.

The sunroof only works when the ignition is switched on. Once the ignition has been switched off, you can still open or close the sunroof for a few minutes provided the driver door and the front passenger door are not opened.

### WARNING

If the sunroof is used negligently or without paying due attention, it can cause serious injury.

- Open or close the sunroof and the sun blind only when no one is in their path of movement.
- Never leave any key inside the vehicle when exiting.
- Never leave a child or any other person who may need help in the vehicle, especially if they have access to the vehicle key. If using the key unattended, they could lock the vehicle, start the engine, switch on the ignition and activate the sunroof.
- After switching off, it is still possible to open or close the sunroof during a short space of time provided that neither the driver nor passenger door is opened.

### CAUTION

- To prevent damage, during winter temperatures remove any ice or snow that might be on the car roof before opening the sunroof or adjusting the tilt position.
- Before leaving the vehicle or in case of rainfall, always close the sunroof. With the sunroof open or in a tilted position, water can enter the interior and can cause considerable damage to the electrical system. As a result, other damage can occur in the vehicle.

### Note

- Leaves and other loose objects that accumulate on the sunroof rails should be regularly cleaned away either by hand or with a vacuum.
- If the sunroof does not work correctly, the anti-trap function will not work either. Contact a specialised workshop.

### Opening and closing the sunroof

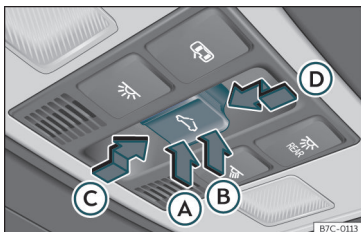

Fig. 84 On the interior roof lining: sunroof button.

The sun blind automatically opens along with the sunroof if completely closed or if in front of the sunroof. The sun blind remains in the previous position and does not automatically close with the sunroof. The sun blind can only be closed completely once the sunroof has been closed.

The button Fig. 84 has two levels. The first level switches the sunroof to the tilted position, opening or closing it fully or partially.

On the second level, the sunroof automatically moves to the corresponding final position after briefly pressing the button. Activating the button again stops the automatic function.

#### Adjusting the tilt position of the sunroof

- Press the rear part of the button (B) to the first level.
- Automatic function: briefly press the rear part of button (B) to the second level.

#### Closing the sunroof from a tilted position

- Press the front part of the button (A) to the first level.
- Automatic function: briefly press the front part of the button (A) to the second level.

#### Stopping the automatic operation by adjusting the tilted position of the sunroof or by closing the sunroof

- Press button (A) or (B) again.

#### Opening the sunroof

- Press button (C) backwards to the first level.

- Automatic function to the comfort position: briefly press button (C) backwards to the second level.

#### Closing the sunroof

- Press button (D) forwards to the first level.
- Automatic function: briefly press button (D) forwards to the second level.

#### Stopping the automatic operation during the opening or closing

- Press button (C) or (D) again.

### Opening and closing the sunshade blind

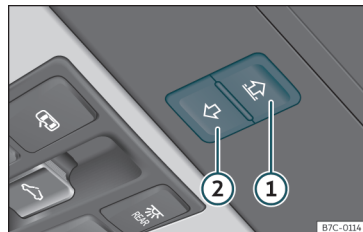

Fig. 85 On the interior roof lining: sunshade blind buttons.

The electrical sun blind works when the ignition is switched on.

When the sunroof is in its most tilted position, the sun blind automatically goes into a ventilation position. The sun blind remains in this position also with the sunroof closed.

Buttons >>> Fig. 85 ① and ② have two levels. The first level opens or closes the sun blind fully or partially.

By briefly pressing the button to the second level, the sun blind automatically moves to the corresponding final position. Activating the button again stops the automatic function.

Once the ignition has been switched off, you can still open or close the sun blind for a few minutes provided the driver door and the front passenger door are not opened.

### Opening the sun blind

- Press button ① to the first level.
- Automatic function: briefly press button ① to the second level.

### Closing the sun blind

- Press button ② to the first level.
- Automatic function: briefly press button ② to the second level.

### Stopping the automatic operation during the opening or closing

- Press button ① or ② again.

#### Note

When the sunroof is open, the electric sun blind can only be closed to the front edge of the sunroof.

### Convenience function to open or close the sunroof\*

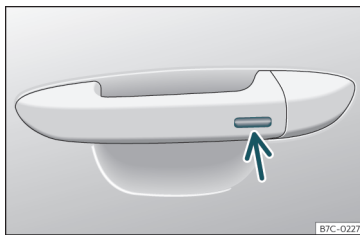

Fig. 86 Door handle: sensor surface.

The sunroof can be opened and closed with the convenience function, just like the windows.

### Using the door lock\*

- Hold the key in the door lock of the driver door in either the unlocking or locking position to open or close the roof in the tilted position. Release the key to interrupt this function.

### Using the remote control

- Keep the locking or unlocking button pressed to open or close the roof. If you release the button the opening or closing will stop.

### Using the Keyless Access\* system (only closing)

- Press and hold the locking sensor surface >>> Fig. 86 (arrow) on the door handle to close the sunroof. If you release the sensor surface, the closing movement stops.



### Anti-trap function of the panoramic sunroof and sunshade

The anti-trap function can reduce the risk of injury when closing the sunroof and the sun blind >>> Δ. If the sunroof or sun blind encounter resistance or an obstacle when closing, they reopen immediately.

- Check why the sunroof or sun blind do not close.
- Try to close the sunroof or sun blind again.
- If the sunroof or sun blind cannot be closed due to an obstacle or some resistance, it stops at the corresponding position and then opens. For automatic closing, a new closing attempt might take place.

- If the sunroof or sun blind is still unable to close, close it without the anti-trap function.

### Closing the sunroof or sun blind without the anti-trap function

- *Sunroof*: within approximately 5 seconds of having activated the roll-back function, press the  button **>>> Fig. 84** to the second level in the direction of arrow **>>> Fig. 84**  until the sunroof closes completely.
- *Sun blind*: within approximately 5 seconds of having activated the anti-trap function, press button **>>> Fig. 85**  until the sun blind closes completely.
- **The sunroof or sun blind close without the anti-trap function intervening!**
- If the sunroof or sun blind will still not close, visit a specialised workshop.

#### **WARNING**

Closing the sunroof or sun blind without the anti-trap function can cause serious injuries.

- Always be careful when closing the sunroof and sun blind.
- No person should ever remain in the way of the sunroof or sun blind, especially when closing without the anti-trap function.
- The anti-trap function does not prevent fingers or other parts of the body from becoming trapped against the roof frame and injuries occurring.

## Lights

### Vehicle lighting

#### Control lamps

##### It lights up

Driving light totally or partially faulty.

##### It lights up

Rear fog light switched on **>>> page 109.**

##### It lights up

Left or right turn signal.  
The control lamp flashes twice as fast when a turn signal is faulty.

Hazard warning lights on **>>> page 112.**

##### It lights up

Trailer turn signals

##### It lights up

Main beam on or flasher on **>>> page 109.**

##### It lights up

The Light Assist system is on **>>> page 111.**

Several warning and control lamps light up for a few seconds when the ignition is switched on, signalling that the function is being verified. They will switch off after a few seconds.

#### **WARNING**

Observe the safety warnings **>>> ** in Control and warning lamps on page 79.



### Headlight switch



**Fig. 87** Dash panel: lights control.

- Turn the switch to the required position **>>> Fig. 87.**

Sym- bol	Ignition switched off	Ignition is switched on
0	Fog lights, dipped beam and side lights off.	Daylight running lights switched on. <b>&gt;&gt;</b>

Symbol	Ignition switched off	Ignition is switched on
<b>AUTO</b>	The "Coming home", "Leaving home" and Welcome lights may be switched on.	Automatic control of dipped beam and daytime running light.
	Side light on.	Daylight running lights switched on.
	Dipped beam headlight off	Dipped beam switched on.

The driver is personally responsible for the correct use and adjustment of the lights in all situations.

### Automatic dipped beam headlight control **AUTO\***

The automatic dipped beam control is merely intended as an aid and is not able to recognise all driving situations.

When the light switch is in position **AUTO**, the vehicle lights and the instrument panel and switch lighting switch on automatically in the following situations >>> :

- The photo sensor detects *darkness*, for example, when driving through a tunnel. They switch off when adequate lighting is detected.

- The rain sensor detects rain and activates the wipers. They switch off when the wipers have not been activated for a few minutes.

### Daytime running lights

The daytime running lights consist of individual lights, integrated in the front headlights. These lights come on when the daytime running lights are switched on. On vehicles equipped with LED tail lights, the rear side light is switched on as well >>> .

The daytime running lights turn on every time the ignition is switched on, if the switch is in position **0** or **AUTO**, according to the level of exterior lighting.

When the light switch is in position **AUTO**, a light sensor automatically switches dipped beam on and off (including the control and instrument lighting) or the daytime running lights depending on the level of exterior lighting.

### Motorway light\*



The function is connected and disconnected via the corresponding Easy Connect system menu.

- **Activation:** when going above 110 km/h (68 mph) for more than 30 seconds, the dipped beam raises slightly to increase the driver's visibility distance.

- **Deactivation:** when reducing the speed of the vehicle below 100 km/h (62 mph), the dipped beam immediately returns to its normal position.

### Audible warnings to advise the driver that the lights have not been switched off

If the key is not in the ignition and the driver door is open, an audible warning signal is heard in the following cases: this will remind you to turn the light off.

- When the parking light is on >>> page 109.
- When the light switch is in position  or .

### **WARNING**

If the road is not well lit and other road users cannot see the vehicle well enough or at all, accidents may occur.

- The automatic dipped beam control (**AUTO**) only switches on the dipped beam when there are changes in light conditions but not, for example, when it is foggy.

### **WARNING**

The side lights or daytime running lights are not bright enough to illuminate the road ahead and to ensure that other road users are able to see you.

- Always use your dipped beam headlights if it is raining or if visibility is poor.

- Never drive with daytime lights if the road is not well lit due to weather or lighting conditions.
- On vehicles with rear lights with bulbs, when activating the daytime running light the rear lights are not switched on. A vehicle which does not have the rear lights on may not be visible to other drivers in the darkness, in the case of heavy rain or in conditions of poor visibility.

## ⚠ WARNING

If the headlights are set too high and not used correctly, there is a risk of dazzling or distracting other road users. This could result in a serious accident.

- Always make sure that the headlights are correctly adjusted.

## i Note

- The legal requirements regarding the use of vehicle lights in each country must be observed.
- The dipped beam headlights will only work with the ignition on. The side lights come on automatically when the ignition is turned off.

## Fog lights

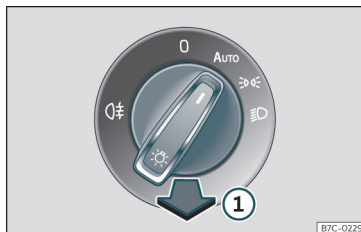

Fig. 88 Dash panel: lights control.

The warning lamp (fog lamp symbol) on the light control or the instrument panel, also shows when the fog lights are on.

- **Turning on the rear fog light** (fog lamp symbol): pull the light switch fully out >>> Fig. 88 ① from position AUTO.
- To switch off the fog lights, press the light switch or turn it to position 0.

## i Note

The rear fog light can dazzle drivers behind you. You should use the rear fog light only when visibility is very poor.

## Turn signal and main beam lever

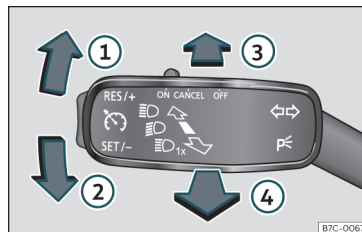

Fig. 89 Turn signal and main beam lever.

Move the lever to the required position:

- ① Right turn light or right-hand parking light (ignition switched off).
- ② Left turn light or left-hand parking light (ignition switched off).
- ③ Main beam on: control lamp lit up on the instrument panel.
- ④ Light flash: on with the lever pushed. Control lamp lit up.

Push the lever all the way down to turn off the corresponding function.

## Convenience turn signals

When the ignition is switched on, move the lever as far as possible upwards or downwards and release the lever. The turn signal will flash three times. »

The convenience turn signal is activated and deactivated in the Easy Connect system using the button  > **SETTINGS** > **Lights** > **Light assistance** > **Convenience turn signal** >>> page 80.

In vehicles that do not have the corresponding menu, this function can be deactivated in a specialised workshop.

### Parking light

The parking lights will only work with the ignition off. If said light is on, an audible warning will sound while the driver door is open.

- Switch the ignition off.
- Move the turn signal lever up or down.

When the parking light is switched on, the front side light and the tail light on the corresponding side of the vehicle turn on.

### Parking light on both sides

- Switch the ignition off.
- Place the light switch in position .
- Lock the vehicle from the outside.

In doing so, only the side lights of both headlights light up, and additionally the tail lights will do so partially.

### WARNING

Improper or lack of use of the turn signals, or forgetting to deactivate them can confuse other road users. This could result in a serious accident.

- Always give warning when you are going to change lane, overtake or when turning, activating the turn signal in good time.
- As soon as you have finished changing lane, overtaking or turning, switch the turn signal off.

### WARNING

Incorrect use of the headlights may cause accidents and serious injury, as the main beam may distract or dazzle other drivers.

### Note

- If the convenience turn signals are operating (three flashes) and the other convenience turn signals are switched on, the active part stops flashing and only flashes once in the new part selected.
- The turn signal only works when the ignition is switched on. The hazard warning lights also work when the ignition is switched off.
- If a trailer turn signal malfunctions, the control lamp will stop flashing (trailer turn signals) and the vehicle turn signal will flash at double speed.

- The *main beam headlights* can only be switched on if the dipped beam headlights are already on.
- In cold or damp weather conditions, the headlights, tail lights and turn signals may mist up inside temporarily. This is normal and in no way effects the useful life of the vehicle lighting system.
- The parking light does not activate automatically if the left- or right-hand turn signal is left on and the ignition is disconnected.

### Main beam assist (Light Assist)\*



The main beam assist acts within the limits of the system and depending on environmental and traffic conditions. Once switched on, the system is activated as of a speed of about 60 km/h (37 mph) and is deactivated below about 30 km/h (18 mph) >>> .

When the system is activated and the camera detects other vehicles that may be dazzled, the main beam is automatically switched off. Otherwise, the main beam is automatically switched on.

The main beam assist generally detects illuminated areas and deactivates the main beam when passing through a town, for example.



## Switching the main beam assist on

- Turn on the ignition and turn the light switch to the position **AUTO**.
- From the base position, press the turn signal and main beam headlights lever forwards >>> **Fig. 89**  When the lamp  is displayed on the instrument panel display, the main beam assist is switched on.

## Switching the main beam assist off

- Turn the light switch to a position other than **AUTO** >>> page 107.
- **OR:** while the main beam is on, pull the turn signal light and main beam headlights lever forwards >>> **Fig. 89** .
- **OR:** push the turn signal and main beam headlight lever forwards to manually turn on the main beam. The main beam assist will then be deactivated.

## Malfunctions

The following conditions may prevent the main beam headlight control from turning off the headlights in time or from turning off altogether:

- In poorly lit towns with highly reflective signs.
- Other insufficiently lit road users (such as pedestrians or cyclists).

- On tight bends and steep slopes (bumps) and when oncoming vehicles are partially obscured.
- When the drivers of other oncoming vehicles (such as a truck) can see over a guard rail in the centre of the road.
- If the camera is damaged or the power supply is cut off.
- In fog, snow and heavy rain.
- With dust and sand turbulence.
- With loose gravel in the field of vision of the camera.
- When the field of vision of the camera is misted up, dirty or covered by stickers, snow, ice, etc.

## WARNING

The convenience features of the main beam assist should not encourage the taking of risks. The system is not a replacement for driver concentration.

- You are always in control of the main beam and adapting it to the light, visibility and traffic conditions.
- It is possible that the main beam headlight control does not recognise all driving situations and is limited under certain circumstances.
- When the field of vision of the camera is dirty, covered or damaged, operation of the main beam control may be affected. This also applies when changes are made to

the vehicle lighting system, for example, if additional headlights are installed.

## CAUTION

To avoid affecting the operation of the system, take the following points into consideration:

- Clean the field of vision of the camera regularly and make sure it is free of snow and ice.
- Do not cover the field of vision of the camera.
- Check that the windscreen is not damaged in the area of the field of vision of the camera.

## Note

Main beam and headlight flasher can be turned on and off manually at any time with the turn signal and main beam lever >>> page 109.

## “Coming home” and “Leaving home” function

The “Coming home” and “Leaving home” function lights up the vehicle’s immediate proximity when getting into and out of it in the dark. When switched on, the front position and dipped beam lights, tail lights and license plate light come on. »

The “Leaving Home” is controlled by a photosensor.

In the vehicle settings menu of the infotainment system you can adjust the duration of the light switch-off delay, and activate and deactivate the function.

### Activating the “Coming Home” function

*For vehicles with light and rain sensors.*

- Switch off the engine and remove the key from the ignition with the light switch in position **AUTO** >>> page 107.
- The automatic “Coming Home” function is only active when the light sensor detects darkness.

*For vehicles without light and rain sensors.*

- Switch the ignition off.
- Activate the headlight flashers for *approximately 1 second*.

When the driver door is opened, the “Coming Home” lighting comes on. The *delay in switching off the headlights* is counted from when the last door or boot hatch is closed.

### The “Coming Home” lighting turns off in the following cases:

- Automatically, once the headlight turn off delay has elapsed.

- Automatically, when a vehicle door or the rear lid is still open 30 seconds after starting the engine.

- When the rotary light switch is turned to position **0** >>> page 107.
- With the ignition is switched on.

### Activating the “Leaving Home” function

- Unlock the vehicle using the remote control.
- The “Leaving Home” function is only activated when the light switch is in position **AUTO** and the light sensor detects darkness.

### The “Leaving Home” lighting switches off in the following cases:

- Automatically, when the “Leaving Home” delay period ends (default 30 sec).
- When the vehicle is locked using the remote control.
- When the light switch is turned to position **0**.
- With the ignition is switched on.

### Welcome light

The welcome light is a light located on the exterior mirrors, focused on the ground, which activates or deactivates if the light switch is in the **AUTO** position and the “Coming Home” or “Leaving Home” function is turned on or off.

### Note

To activate the “Coming Home” and “Leaving Home” function, the rotary light switch must be in position **AUTO** and the light sensor must detect darkness.

### Hazard warning lights





Fig. 90 Dash panel: hazard warning lights switch

The hazard warning lights are used to draw the attention of other road users to your vehicle in emergencies.

If your vehicle breaks down:

1. Park your vehicle at a safe distance from moving traffic.
2. Press the button to switch on the hazard warning lights >>> .
3. Switch the ignition off.
4. Apply the electronic parking brake.

5. Move the selector lever to position **P**.
6. Use the warning triangle to draw the attention of other road users to your vehicle.
7. Always take the vehicle key with you when you leave the vehicle.

All turn signals flash simultaneously when the hazard warning lights are switched on. The two turn signal turn signal lamps   and the turn signal lamp in the switch  will flash at the same time. The simultaneous hazard warning lights also work when the ignition is switched off.

### Emergency braking warning

If the vehicle brakes suddenly and continuously at a speed of more than 80 km/h (50 mph), the brake light flashes several times per second to warn the vehicles driving behind. If you continue braking, the hazard warning lights will come on automatically when the vehicle comes to a standstill. They switch off automatically when the vehicle starts to move again.

#### WARNING

- The risk of an accident increases if your vehicle breaks down. Always use the hazard warning lights and a warning triangle to draw the attention of other road users to your stationary vehicle.

- Due to the high temperatures that the catalytic converter can reach, never park in an area where the catalytic converter could come into contact with highly inflammable materials, for example dry grass or spilled petrol. This could start a fire.

#### Note

- The battery will run down if the hazard warning lights are left on for a long time, even if the ignition is switched off.
- The use of the hazard warning lights described here is subject to the relevant statutory requirements.

### Dynamic headlight range control

The headlight range is automatically adjusted according to the vehicle load status when they are switched on.

#### WARNING

Heavy objects in the vehicle may mean that the headlights dazzle and distract other drivers. This could result in a serious accident.

- Adjust the light beam to the vehicle load status so that it does not blind other drivers.

### Driving abroad

The light beam of the dipped beam lights is asymmetric: the side of the road on which you are driving is lit more intensely.

When a car that is manufactured in a country that drives on the right travels to a country that drives on the left (or vice versa), it is normally necessary to cover part of the headlight bulbs with stickers or to change the adjustment of the headlights to avoid dazzling other drivers.

In such cases, the regulations specify certain light values that must be complied with for designated points of the light distribution. This is known as “Tourist light”.

The light distribution of the halogen and full-LED headlights allows the specific “tourist light” values to be met without the need for stickers or changes in the settings.

#### Note

“Tourist light” is only allowed temporarily. If you are planning a long stay in a country that drives on the other side, you should take the vehicle to an Authorised Technical Service to change the headlights.

## Interior lights

### Lighting of the instrument panel, displays and switches

Depending on the model, the lighting of the instrument panel and controls can be adjusted in the Easy Connect system, using the button  > **SETTINGS** >>> page 80.

In certain cases, when the engine is running and the lights are not switched on; e.g., passing through a tunnel without having activated the **AUTO** function, a **Switch on the Lights** warning will appear on the instrument panel.

### Interior and reading lights<sup>1)</sup>

#### Glove compartment and luggage compartment lighting\*

When opening and closing the glove compartment on the front passenger side and the rear lid, the respective light will automatically switch on and off.

<sup>1)</sup> Depending on the features fitted in the vehicle, LEDs can be used for the following interior lights: front vanity mirror light, rear vanity mirror light, footwell light, sun blind and glove compartment light.

#### Footwell lighting\*

The lights in the footwell area below the dash (driver and front passenger sides) will switch on when the doors are opened and will decrease in intensity while driving. The intensity of these lights can be adjusted using the radio menu (see **Easy Connect > Light Settings > Interior Lighting** >>> page 80).

#### Ambient light\*

The ambient light lights up the area of the centre console, the footwell area and, depending on the version, the front door panels.

The ambient lighting in the door panels may change colour. The brightness and colour of these lights can be adjusted using the radio menu (see **Easy Connect > Light Settings > Interior Lighting** >>> page 80).

#### Note

The reading lights switch off when the vehicle is locked using a key or after several minutes if the key is removed from the ignition. This prevents the battery from discharging.

## Visibility

### Windscreen wiper and rear window wiper systems

#### Window washer lever

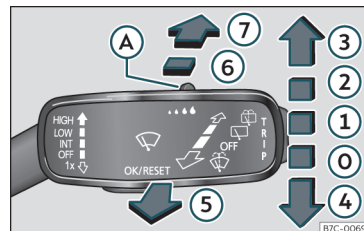





**Fig. 91** Operating the windscreen wiper and rear wiper.

#### More the lever to the required position:

 **OFF** Windscreen wipers off.

## Move the lever to the required position:

①	<b>INT</b>	Wiper intervals. Use control » Fig. 91  to set the interval (vehicles without rain sensor), or the sensitivity of the rain sensor.
②	<b>LOW</b>	Slow wipe.
③	<b>HIGH</b>	Continuous wipe.
④	<b>1x</b>	Short wipe. Brief press, short clean. Hold the lever down for more time to increase the wipe frequency.
⑤		Windscreen washer. The windscreen washer function is activated by pushing the lever towards the steering wheel, and the wipers operate simultaneously.
⑥		Interval wipe for rear window. The wiper will wipe the window approximately every six seconds.
⑦		The rear window wash function is activated by pressing the lever, and the rear wiper starts simultaneously.

## WARNING

In cold conditions you should not use the wash/wipe system unless you have warmed the windscreen with the heating and ventilation system. The windscreen washer fluid could otherwise freeze on the windscreen and obscure your view of the road.

## CAUTION

If the ignition is switched off with the windscreen wipers active, they complete their wipe before returning to the rest position. When switching the ignition back on, the windscreen wiper will continue to operate at the same wiping level. Ice, snow and other obstacles on the windscreen may damage the wiper and the windscreen wiper motor.

- If necessary, remove snow and ice from the windscreen wipers before starting your journey.
- Carefully lift the frozen windscreen wipers from the glass. CUPRA recommends a de-icer spray for this operation.
- Do not switch on the windscreen wipers if the windscreen is dry. Cleaning with the windscreen wipers while dry can cause damage.
- In icy conditions, always check that the wiper blades are not frozen to the glass before using the wipers. In cold weather, it may help to leave the vehicle parked with the wipers in service position » page 45.

## Note

- The windscreen and window wipers only function when the ignition is switched on and the bonnet or rear lid, respectively, are closed.
- The interval wipe speed varies according to the vehicle speed. The faster the vehicle

is moving, the more often the windscreen is cleaned.

- The rear wiper is automatically switched on when the windscreen wiper is on and the car is in reverse gear.

## Wiper functions

### Windscreen wipers performance in different situations

- If the vehicle is stopped, the activated position temporarily moves to the previous position.
- The air conditioner comes on for approximately 30 seconds in air recirculation mode when the windscreen washer is activated,  to prevent the smell of the windscreen washer fluid entering the inside the vehicle.
- When wiping at intervals, the intervals vary according to the speed. The higher the vehicle speed the shorter the intervals.

### Heated windscreen washer jets\*

The heating only thaws the frozen jets, it does not thaw the water in the washer hoses. When the ignition is switched on the heated windscreen washer jets automatically adjust the heat depending on the ambient temperature.



## Headlight washer system\*

The headlight washer cleans the glass of the headlights and only works when the dipped beam headlights are on. After switching on the ignition, the headlights are also washed when the automatic wiper is activated for the first time and then every fifth time.

Regularly clean dirt that has become encrusted on the headlights, e.g., remains of insects.

To ensure the headlight washers work correctly in winter, clean away any snow that may be present on the jet covers located on the bumper. If necessary, remove ice with an anti-ice spray.

### Note

- The wiper will try to wipe away any obstacles that are on the windscreen. The wiper will stop moving if the obstacle blocks its path. Remove the obstacle and switch the wiper back on again.
- If you stop the vehicle with the windscreen wiper in position 1 or 2, it will automatically change to a lower position speed. The set speed will be resumed when the vehicle pulls away.
- The windscreen will be wiped again approximately 5 seconds after the windscreen washer has been activated, provided the vehicle is moving ("drip" function). If you activate the wipers less than 3 seconds after the "drip" function, a new wash se-

quence will begin without performing the last wipe. For the "drip" function to work again, you have to turn the ignition off and then on again.

## Rain sensor

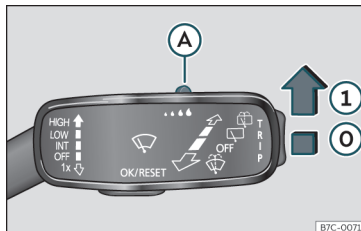

Fig. 92 Wiper lever: adjust the rain sensor (A)

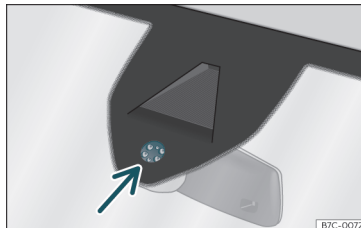

Fig. 93 Rain sensor sensitive surface

The rain sensor controls the frequency of the windscreen wiper intervals, depending on the amount of rain »» » Δ. The sensitivity of the rain sensor can be adjusted manually. Manual wipe »» » page 114.

Move the lever to the required position »» » Fig. 92:

- Rain sensor off.
- ① Rain sensor on; automatic wipe if necessary.
- Ⓐ Setting sensitivity level of rain sensor
  - Set control to the right: high sensitivity.
  - Set control to the left: low sensitivity.

When the ignition is switched off and then back on, the rain sensor stays on and starts operating again when the windscreen wipers are in position ① and the vehicle is travelling at more than 16 km/h (10 mph).

## Modified behaviour of the rain sensor

Possible causes of faults and mistaken readings on the sensitive surface »» » Fig. 93 of the rain sensor include:

- Damaged wipers: a film of water on the damaged blades may lengthen the activation time, reduce the washing intervals or result in a fast and continuous wipe.
- Insects: insects on the sensor may trigger the windscreen wiper.

- Salt on the road: in winter, salt spread on the roads may cause an excessively long wipe when the windscreen is almost dry.
- Dirt: dry dust, wax, coating on glass (Lotus effect) or traces of detergent (car wash) may reduce the effectiveness of the rain sensor or make it react more slowly, later or not at all.
- Windscreen crack: the impact of a stone will trigger a single wipe cycle with the rain sensor on. Next the rain sensor detects the reduction in the sensitive surface area and adapts accordingly. The behaviour of the sensor will vary with the size of the damage caused by the stone.

## ⚠ WARNING

The rain sensor may not detect enough rain to switch on the wipers.

- If necessary, switch on the wipers manually when water on the windscreen obstructs visibility.

## 📄 Note

- Clean the sensitive surface of the rain sensor regularly and check the blades for damage »» Fig. 93 (arrow).
- To remove wax and coatings, we recommend a window cleaner containing alcohol.
- Do not put stickers on the windscreen in front of the rain sensor\*. This may cause sensor disruption or faults.

## Mirrors

### Interior mirror anti-dazzle function

#### Rear view mirror with automatic anti-dazzle function\*

The anti-dazzle function is activated every time the ignition is switched on.

When the anti-dazzle function is enabled, the interior rear vision mirror will darken **automatically** according to the amount of light it receives. The anti-dazzle function is cancelled if reverse gear is engaged.

## ⚠ WARNING

In the event that an automatic anti-dazzle rear vision mirror breaks, an electrolyte fluid may leak. This could cause irritation to the skin, eyes and respiratory organs. If you come into contact with this liquid, it must be rinsed with large quantities of water. If necessary, get medical help.

## ⚠ CAUTION

In the event that an automatic anti-dazzle rear vision mirror breaks, an electrolyte fluid may leak. This liquid attacks plastic surfaces. Clean it with a wet sponge as soon as possible.

## 📄 Note

- If the light incident in the interior rear vision mirror is obstructed (e.g. with the sun blind\*), the anti-dazzle rear vision mirror with automatic setting will not operate perfectly.
- When the interior lights are on or reverse gear engaged, the mirrors do not darken with automatic adjustment for anti-dazzle position.
- If you have to stick any type of sticker on the windscreen, do not do so in front of the sensors. Doing so could prevent the anti-dazzle function from working well or even from working at all.

### Adjusting the exterior mirrors

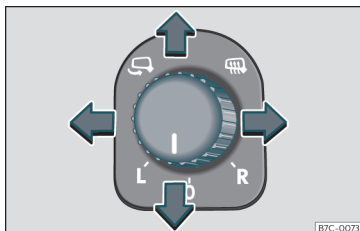



Fig. 94 Detail of the driver's door: control for the exterior mirror.

Turn the control to the corresponding position:

**L/R** Turning the knob to the desired position, adjust the mirrors on the driver side (L, left) and the passenger side (R, right) to the direction desired.

 Depending on the equipment fitted on the vehicle, the mirrors may be heated according to the outside temperature.

 Folding in mirrors.

### Synchronized regulation of the exterior mirrors

In the Easy Connect system menu, select  > **Settings** > **Mirrors and wipers** > **Mirrors** if the exterior mirrors have to be adjusted in a synchronised manner.

- Turn the knob to position **L**<sup>1)</sup>.
- Adjust the left-hand exterior mirror. The right exterior mirror will be adjusted at the same time (synchronised).
- If necessary, correct the right-hand rear-view mirror: rotate the control to position **R**<sup>1)</sup>.

### Tilt function for front passenger exterior mirror\*

When parking backwards, and in order to be able to see the kerb, the passenger side mirror can be automatically tilted towards the passenger to provide a better view of the kerb. The control must be in the position **R**<sup>1)</sup> for this feature to be operational.

The mirror returns to its original position as soon as you drive forward at over 15 km/h (9 mph) or switch off the ignition. It also returns to its original position if the position of the control is adjusted.

### Storing the rear view mirror settings for the tilt function

- Switch the ignition on.
- Using the Easy Connect system, button  > **SETTINGS** > **Mirrors and wipers** > **Mirrors** select **Lower while reversing** >> page 80 .
- Select the **R**<sup>1)</sup> position on the control.
- Select reverse gear.
- Adjust the front passenger exterior mirror so that you can see, for example, the kerb area well.
- Release the reverse gear.

- The adjusted position for the rear view mirror is stored.

### Fold the rearview mirrors when locking the vehicle\*

The Easy Connect system, button  > **SETTINGS** > **Mirrors and wipers** > **Mirrors** can be used to have the exterior mirrors fold in when the vehicle is parked and locked >>> page 80.

When the vehicle is locked with the remote control, the exterior mirrors are retracted automatically. When the vehicle is opened with the remote control, the exterior mirrors are deployed automatically.

#### **WARNING**

Convex or wide-angle\* exterior mirrors give a larger field of vision. However, they make objects look smaller and further away than they really are. If you use these mirrors to estimate the distance to vehicles behind you when changing lane, you could misjudge the distance. Risk of accident!

#### **WARNING**

Fold and unfold the exterior mirror, taking care to avoid injuries.

<sup>1)</sup> Regulation in right-hand drive vehicles is symmetrical.



- Only fold or unfold the exterior mirror when there is no-one in the way of the mirror.
- When moving the mirror, take care not to trap fingers between the mirror and the mirror bracket.

**CAUTION**

- If one of the mirror housings is knocked out of position (e.g. when parking), the mirrors must first be fully retracted with the electric control. Do not readjust the mirror housing by hand, as this will interfere with the mirror adjuster function.
- Before washing the vehicle in an automatic car wash, please make sure to retract the exterior mirrors to prevent them from being damaged. Electrically retractable exterior mirrors must not be folded in or out by hand. Always use the electrical power control.

**Note**

- If the electrical adjustment should fail to operate, both of the mirrors can be adjusted by hand by lightly pressing the edge of the mirror glass.
- The fold-in function on the exterior mirrors will not activate at speeds over 40 km/h (25 mph).

## Sun protection

### sun blind

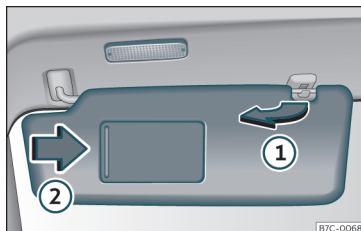

Fig. 95 Sun visor

### Options for adjusting driver and front passenger sun visors

- Lower the sun visor towards the wind-screen.
- The sun visor can be pulled out of its mounting and turned towards the door >>> Fig. 95 ①.
- Swing the sun visor towards the door, longitudinally backwards.

There is a vanity mirror on the sun visor, with a cover. When the cover is opened ② a light comes on.

The lamp goes out when the vanity mirror cover is closed or the sun visor is pushed back up.

**WARNING**

Folded sun blinds can reduce visibility.

- Always store sun blinds and visors in their housing when not in use.

**Note**

The light above the sun visor automatically switches off after a few minutes in certain conditions. This prevents the battery from discharging.

## Seats and headrests

### Adjusting seats

#### Manual adjustment of the front seats



Fig. 96 Front seats: manual seat settings.

- ① Forwards/backwards: pull the lever and move the seat. The seat must engage when the lever is released!
- ② Raise/lower: pull the lever up or push down (several times if necessary) from its home position.
- ③ Tilting the backrest: turn the hand wheel.
- ④ Lumbar support: move the lever until the required position is achieved.

#### ⚠ WARNING

Incorrect seat adjustment may lead to accidents and severe injuries.

- Only adjust the seats when the vehicle is stationary, as the seats could move unexpectedly while the vehicle is in motion and you could lose control of the vehicle. Furthermore, an incorrect position is adopted when adjusting the seat.
- Adjust the height, position and inclination of the front seats only when their movement area is empty.
- Make sure there are no objects in that area.
- Make sure that the movement and locking areas of the seats are clean.

#### ⚠ WARNING

Incorrectly using upholstery and seat covers might cause an accidental activation of the electrical seat adjustment system and make it move unexpectedly while driving. This might cause loss of control of the vehicle and thus accidents or injuries. Moreover, the electrical components of the front seats might be damaged.

- Never attach or place seat upholstery or covers on the electric controls.
- Never use upholstery or seat covers that have not been explicitly authorised for the seats of the vehicle.

#### Electric driver's seat adjustment\*

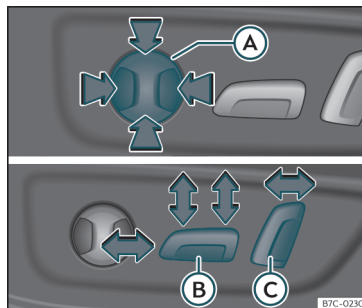

Fig. 97 Driver's seat: electric seat settings.

- Ⓐ Adjust the lumbar support: press the button according to the desired position.
- Ⓑ Seat forwards/backwards: press the button forwards/backwards.  
Seat up/down: Press the rear part of the button up/down. To adjust the angle of the seat cushion, press the front of the button up/down.
- Ⓒ Backrest further upright/further reclined: press the button forwards/backwards.

### WARNING

- If the electric front seats are used negligently or without paying due attention, it can cause serious injury.
- The front seats can also be electrically adjusted when the ignition is switched off. Never leave a child or any other person who may need help in the vehicle.
- In the event of an emergency, electrical adjustment can be stopped by pressing any control.

### CAUTION

To avoid damaging the electrical components of the front seats, please refrain from kneeling on the seat or applying sharp pressure at a single point to the seat cushion and backrest.

### Note

- It may not be possible to electrically adjust the seat if the vehicle battery is very low.
- If the engine is started while the seats are being electrically adjusted, the adjustment will stop.

## Headrest

### Introduction

The possibilities for the adjustment and disassembly of the headrests are described below. Always make sure that the seats are correctly adjusted >>> page 12.

All seats are equipped with a headrest. The central rear headrest is only intended for the central seat of the rear bench. Therefore, do not install it on any other seat.

### Correct adjustment of headrest

Adjust the headrest so that its upper edge is at the same level as the top of your head and under no circumstances below eye level. Keep the back of your head always as close to the headrest as possible.

### Adjusting the headrest for short people

Lower the headrest completely, even if your head is below its upper edge. In the lowest position, there may be a small distance between the headrest and the backrest.

### Adjusting the headrest for tall people

Push the headrest up as far as it will go.

### WARNING

If travelling with the headrests removed or improperly adjusted, the risk of severe or fatal injuries in the event of accidents and sudden braking or manoeuvres increases.

- Always travel with the headrest correctly installed and adjusted.
- To decrease the risk of cervical injuries in the event of an accident, adjust the headrest correctly based on your height, always making sure that its upper edge is at the same height as the top of the head, but never below eye level. Keep the back of your head always as close to the headrest as possible and centred.
- Never adjust the headrest while the vehicle is in motion.
- Under no circumstances should the rear passengers travel while the headrests are in the non-use position.

### CAUTION

When assembling and disassembling the headrests, do not let them meet the top lining of the vehicle, the back rest of the front seat or other parts of the vehicles. If not, this could damage the vehicle.

## Adjusting the headrests

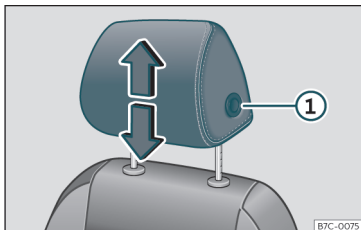

Fig. 98 Front seat: headrest adjustment.

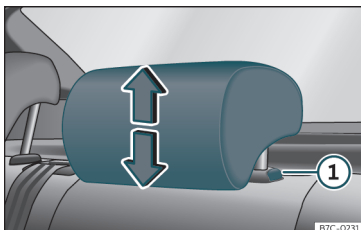

Fig. 99 Rear headrest: headrest adjustment.

### Adjusting the height of the headrests

• Grab the sides of the headrests with both hands and push upwards to the desired position. To lower it, repeat the same action, pressing the ① >>> Fig. 98 >>> Fig. 99 button on the side.

• The headrest must lock correctly in one position.

## Removing and fitting the headrests

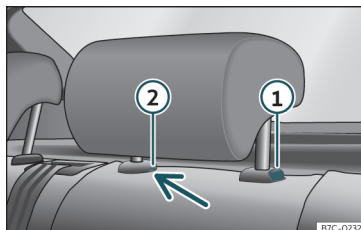

Fig. 100 Rear headrest: removal.

### Removing and fitting the front headrests

• Move the headrest upwards until it arrives to the top.

• Press the side button >>> Fig. 98 ① and remove the headrest.

• To refit, insert the headrest into the holes in the backrest, pushing it down until it engages.

### Removing the rear headrests

To remove the headrest, the corresponding backrest must be partially folded forward.

• Unlock the backrest >>> page 123.

• Move the headrest upwards until it arrives to the top.

• Press button >>> Fig. 100 ①, while simultaneously pressing on the security hole ② with a flat screwdriver a maximum of 5 mm wide, and remove the headrest.

• Move the backrest until it engages properly >>> Δ in Folding down and raising the rear seat backrest on page 123.

### Fitting the rear headrests

To mount the external headrests, the corresponding backrest must be partially folded forward.

• Unlock the backrest >>> page 123.

• Insert the headrest bars into the guides until they perceptibly engage. It should not be possible to remove the headrest from the backrest.

• Move the backrest until it engages properly >>> Δ in Folding down and raising the rear seat backrest on page 123.

### ⚠ WARNING

Remove the rear headrests only when it is necessary to fit a child seat. After removing a child seat, refit the headrest immediately.

### Seat functions

#### Folding down and raising the rear seat backrest

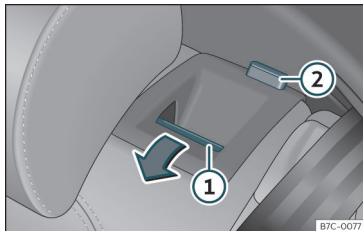

Fig. 101 Rear seat: folding the backrest.

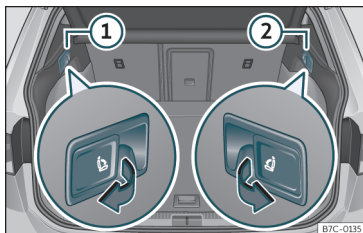

Fig. 102 In the luggage compartment: levers for remote release of the left part ① and right part ② of the rear seat backrest.

The rear seat backrest is split and each part can be lowered forward separately to extend the luggage compartment.

#### Lowering the rear seat backrest with the unlock button

- Push the headrest down as far as it will go >>> page 121.
- Pull the unlock button >>> Fig. 101 ① forward and lift the backrest at the same time. The rear seat backrest is not engaged when the red marking of the button ② is visible.

#### Folding down the backrest from the boot with the unlocking levers

- Push the headrest down as far as it will go >>> page 121.
- Open the rear lid >>> page 98.
- Pull the unlocking lever >>> Fig. 102 of the part of the backrest to fold down.
- The corresponding part of the backrest will be unlocked or will be folded forward.
- If necessary, close the rear lid >>> page 98.

#### Folding up the rear seat backrest

- Lift the backrest and press it firmly into the lock until it engages >>> ⚠.
- It should not be possible to see the red mark of the unlock button ②.
- Make sure that the seat belt is not trapped.

- The backrest must be properly engaged.
- If necessary, adjust the headrest.

#### ⚠ WARNING

Serious injuries can be caused if the rear seat backrest is lowered or lifted without due care and attention.

- When folding down the rear seat, always make sure there are no people or animals in the backrest area.
- Never lower or lift the rear seat backrest while driving.
- Do no trap or damage the seat belt when raising the rear seat backrest.
- When lowering or lifting the rear seat backrest, keep your hands, fingers, feet and other body parts out of its path.
- For the rear seat belts to offer the necessary protection all the parts of the rear backrest must be properly engaged. This is particularly important in the case of the centre rear seat. If someone is seated in a seat whose backrest is not properly engaged they will be thrown forwards, along with the backrest, during an accident or a sudden driving or braking manoeuvre.
- When the rear seat backrest is lowered or is not properly engaged nobody else can travel in the corresponding seats (not even a child).

>>

### ⓘ CAUTION

Serious damage can be caused to the vehicle and other objects if the rear seat backrest is lowered or lifted without due care and attention.

- Before folding the rear seat backrest forward, always adjust the front seats so that neither the headrests nor the cushions of the rear backrest can hit them.
- Before folding the rear seat backrest, always make sure there are no objects in the movement area of the backrest.

### Front centre armrest

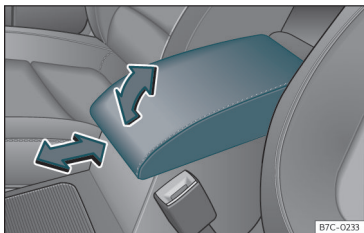

Fig. 103 Front centre armrest

To *lift* the central armrest, lift it upwards in the direction of the arrow >>> Fig. 103, setting by setting.

To *lower* the armrest, first lift it to its highest position. Then lower it down.

To *move* the armrest horizontally, move it forward >>> Fig. 103 or backward as much as possible in the direction of the corresponding arrow.

### ⚠ WARNING

The front centre armrest may obstruct the driver's arm movements, which could cause an accident and severe injuries.

- Keep the storage compartments of the centre armrest closed at all times while the vehicle is in motion.
- Never let anyone sit on the centre armrest while the vehicle is in motion, not even a child. This position is incorrect and may cause severe injuries.

## Transport and practical equipment

### Storing objects

#### Positioning the luggage and cargo

It is possible to carry objects and luggage in the vehicle, in a trailer >>> page 303 and on the roof >>> page 131. When doing so, please consider all legal provisions.

#### Placing luggage inside the vehicle safely

- Distribute the load in the vehicle as evenly as possible.
- Always place equipment and heavy objects in the boot >>> ⚠.
- Position heavy items in the boot as far forward as possible.
- Take into account the maximum authorised weight per axle, as well as the maximum authorised weight of the vehicle >>> page 355.
- Secure the objects to the fastening rings of the boot using appropriate chains or belts >>> page 128.
- Also place small objects safely.
- Adapt tyre pressure to the load. Take into account the pressure adhesive of the tyres >>> page 333.

- In vehicles equipped with tyre control system, adjust to the new load status if necessary »» page 337.

### WARNING

Loose or unsecured objects can cause serious injury in case of sudden manoeuvring or braking or in case of an accident. Particularly if the airbag hits them when deploying and they are thrown across the inside of the vehicle. Please observe the following rules to minimise the risk of injury:

- Place all objects inside the vehicle safely.
- Secure all objects, little and large.
- Place the objects in the cabin in such a way that they can never reach the airbag deployment areas while the vehicle is in motion.
- Keep the storage compartments closed at all times while the vehicle is in motion.
- Place the objects in such a way that they never force any occupant of the vehicle to sit in an incorrect position.
- When transporting objects that take up a seat, never let anyone use that seat.
- Never leave hard, sharp or heavy objects loose in open storage compartment of the vehicle, on the cover behind the rear seat or on the dashboard.
- Remove all hard, sharp or heavy objects from the fabrics and bags inside the cabin and store them safely.

### WARNING

The transport of heavy object changes vehicle handling and increases braking distance. Heavy objects that are not properly placed or secured may cause loss of control of the vehicle and thus severe injuries.

- Never put too much load in the vehicle. Both the carrying capacity as well as the distribution of the load in the vehicle have effects on the driving behaviour and braking ability.
- When transporting heavy objects, the driving behaviour of the vehicle varies due to the displacement of the centre of gravity.
- Always distribute the load in the vehicle as evenly and horizontally as possible.
- Always place heavy objects in the boot before the rear axle and as far away from it as possible.
- Objects in the luggage compartment that are unsecured could move suddenly and modify the handling of the vehicle.
- Adapt your speed and driving style at all times to suit visibility, weather, road and traffic conditions.
- Accelerate with particular care and caution.
- Avoid sudden braking and manoeuvres.
- Brake earlier than usual.

### WARNING

- Never leave your vehicle unattended, especially when the rear lid is open. Children could climb into the luggage compartment, closing the door behind them; they will be trapped and run the risk of death.
- Close and lock all the doors and the rear lid when you leave the vehicle. Before you lock the vehicle, make sure that there are no adults or children in the vehicle.

### CAUTION

Electrical wires or, depending on the features, the antenna embedded into the rear windows could be damaged, even irreparably, if they are in contact with objects.

### Note

Straps for securing the load to the fastening rings are commercially available from accessory shops.

### Luggage compartment

#### Luggage compartment shelf

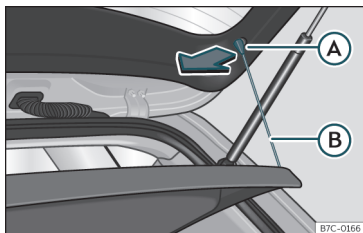

**Fig. 104** In the luggage compartment: removing and fitting the shelf.

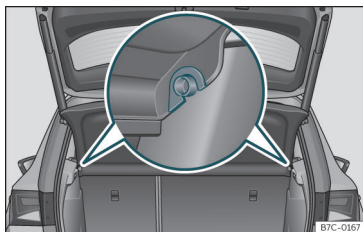

**Fig. 105** In the luggage compartment: removing and fitting the shelf.

#### Removing

- Detach the cord loops >>> **Fig. 104 B** from their hooks **A**.

- Remove the rear shelf from the side supports >>> **Fig. 105** by pulling it upwards and then take it out.

If necessary, the rear shelf can be stored under the luggage compartment double floor >>> page 127.

#### Fitting

- Insert the cover horizontally so that the “recess” fits onto the axis of the supports >>> **Fig. 105** and press down until it engages.
- Hook the loops >>> **Fig. 104 B** to the rear lid.

#### **⚠ WARNING**

Animals, loose or unsecured or objects carried on the rear shelf can cause serious injury in case of sudden manoeuvring or braking or in case of an accident.

- Do not leave hard, sharp or heavy objects or in bags on the rear shelf.
- Never transport animals on the rear shelf.

#### **⚠ CAUTION**

- Before closing the rear lid, ensure that the rear shelf is correctly fitted.
- An overloaded luggage compartment could mean that the rear shelf is not correctly seated and it may be bent or damaged.

- If the luggage compartment is overloaded, remove the tray.

#### **i Note**

Ensure that, when placing items of clothing on the luggage compartment cover, rear visibility is not reduced.



### Store the rear shelf

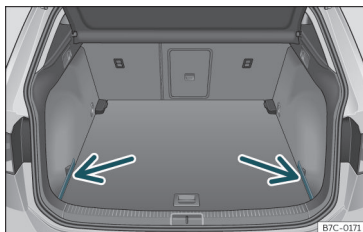

**Fig. 106** In the luggage compartment: covers for storing the rear shelf.



**Fig. 107** In the luggage compartment: fitting the rear shelf.

Depending on the equipment, once the luggage compartment shelf has been removed, it can be stored under the boot floor.

- Remove the left and right covers  
» **Fig. 106.**

- Place the rear shelf in the corresponding housing » **Fig. 107.**
- Put the left and right covers in their original position.

### Variable luggage compartment floor

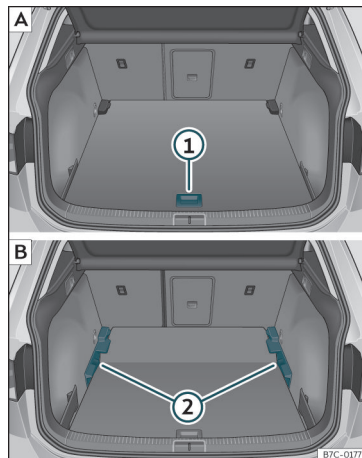

**Fig. 108** Variable luggage compartment floor: **A** raised position; **B** lowered position.

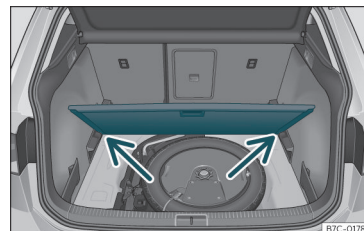

**Fig. 109** Variable luggage compartment floor: inclined position.

#### Variable floor in high position

- To move from the low position to the high position, lift the floor using the handle » **Fig. 108 ①**, and pull it back until the front of the floor has fully passed the supports **②**.
- Move the floor forward over the supports as far as the rear seat backrest and then lower the floor with the handle **①**.

#### Variable floor in low position

- To move from the high position to the low position, lift the floor using the handle » **Fig. 108 ①**, and pull it back until the front of the floor has fully passed the supports **②**.
- Now let the front part fall to the floor and slide the floor forwards as far as the rear seat backrest; lower the floor at the same time with the handle **①**.

»

### Variable floor in the tilted position

When the variable floor is tilted you can access the spare wheel or anti-puncture kit area.

- Lift the variable floor in the high position using handle »» Fig. 108 ①, pull it up and push it towards the backrest of the rear seats until it folds along the hinge line and the movable part of the floor is resting on itself.
- Rest the floor on its housings »» Fig. 109 (arrows).

### Variable floor with folded seats

- To move from the high position to the low position, lift the floor using the handle »» Fig. 108 ① and pull it back a little.
- Push the variable floor towards the folded rear seats with the handle ① using some downward pressure so that the moving part of the floor is flush with the backs of the rear seats.

#### **⚠ WARNING**

- Always secure objects, even when the luggage compartment floor is properly lifted.
- Only objects that do not protrude more than 2/3 the height of the floor may be carried between the rear seat and the raised luggage compartment floor.

- Only objects that do not weigh than approximately 7.5 kg may be carried between the rear seat and the raised luggage compartment floor.

#### **ⓘ CAUTION**

- The maximum weight that can be loaded on the luggage compartment variable floor in the top position is 100 kg.
- Do not let the luggage compartment floor fall when closing it. Always carefully guide it downwards in a controlled manner. Otherwise, the lining and the floor of the luggage compartment could be damaged.

### Fastening rings\*

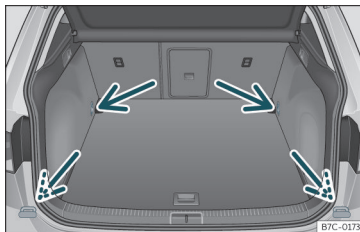

**Fig. 110** In the luggage compartment: fastening rings.

There are fastening rings »» Fig. 110 on the front and rear of the boot to secure loose

objects and luggage with fastening belts and cords.

In order to use the fastening rings, they must be lifted beforehand.

#### **⚠ WARNING**

If unsuitable or damaged belts or retaining straps are used, they could break in the event of braking or an accident. Objects could then be launched across the passenger compartment and cause serious or fatal injuries.

- Always use belts or straps that are suitable and in good condition.
- Tighten the belts and straps in a cross layout over the load placed on the boot floor and secure them to the fastening rings safely.
- Never exceed the maximum tensile load of the fastening rings when securing objects.
- Make sure that, particularly for flat objects, the upper edge of the load is higher than the fastening rings.
- Depending on the features, take into account the instruction panels on the boot on how to place the load.
- Never secure a child seat to the fastening rings.

### Note

- The maximum tensile load that the fastening rings can support is approx. 3.5 kN.
- Belts, straps and securing systems for the appropriate load can be obtained from specialised dealerships. To do so, CUPRA recommends going to a specialised CUPRA dealer or any SEAT dealership.
- The fastening rings are rendered unusable for versions with a spare wheel.

### Net bag\*

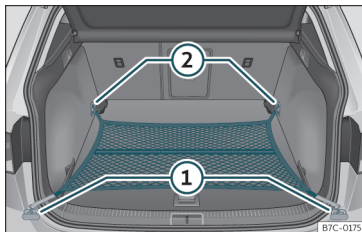

**Fig. 111** In the luggage compartment: net bag hooked up at floor level.

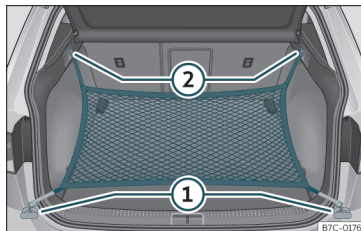

**Fig. 112** In the luggage compartment: rings ① and hooks ② for attaching the net bag.

The luggage compartment prevents light luggage from moving. The net bag has a zip and can be used to store small objects.

The net bag can be hooked up to the luggage compartment in different ways.

#### Hooking the net bag into the luggage compartment floor

If necessary, the front eyes must be unfolded first >>> page 128 .

- Secure the net hooks to the fastening rings ① and ② >>> Fig. 111 >>> ⚠. The bag zip should be facing upwards.

#### Hook the net bag next to the load threshold

- Secure the short net hooks to the fastening rings >>> Fig. 112 ① >>> ⚠. The bag zip should be facing upwards.

- Secure the straps in the bag hooks ②.

#### Removing the net bag

The hooked up net bag is taut >>> ⚠.

- Release the net bag from the fastening rings.
- Store the net bag in the luggage compartment.

### ⚠ WARNING

To secure the elastic net bag on the fastening rings of the boot it must be stretched out. Once hooked up it is taut. If the net bag is hooked up or unhooked incorrectly the hooks could cause injuries.

- Always secure the bag hooks properly so that they do not suddenly release from the fastening rings when hooking or unhooking them.
- On hooking or unhooking them, protect your eyes and face in case the hooks are released suddenly.
- Always hook up the net bag hooks in the described order. If a hook is unfastened suddenly, this may cause injuries.

## Bag hooks

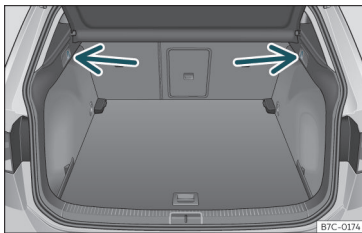

**Fig. 113** In the luggage compartment: bag hooks.

There may be hooks for hanging bags on both sides of the luggage compartment»» **Fig. 113**.

The retaining hooks have been designed to secure light shopping bags.

### **⚠ WARNING**

Never use the hooks to hang luggage or other objects. In case of sudden braking or an accident, the hooks could break.

### **ⓘ CAUTION**

Each hook is designed for a maximum load of 2.5 kg.

## Trapdoor for transporting long objects\*

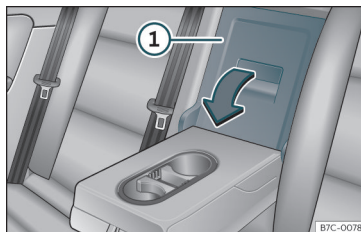

**Fig. 114** In the rear seat backrest: opening the trapdoor.

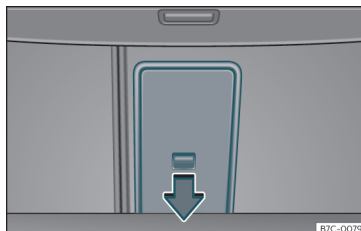

**Fig. 115** In the luggage compartment: opening the trapdoor.

On the rear seat, behind the central armrest, there is a tailboard for transporting long items in the interior, such as skis.

To avoid soiling the interior, dirty objects should be wrapped (e.g. in a blanket) before they are inserted through the tailboard.

When the armrest is down, nobody may travel in the centre rear seat.

### Opening the tailboard

- Lower the centre armrest.
- Pull the release lever in the direction of the arrow and push the tailboard cover »» **Fig. 114** ① down and forwards.
- Open the rear lid.
- Insert the long objects through the gap from the luggage compartment.
- Secure the objects with the seat belt.
- Close the rear lid.

### Closing the tailboard

- Lift the tailboard cover until it engages. The red mark on the luggage compartment side should never be visible.
- Close the rear lid.
- Lift the centre armrest if necessary.

### **i Note**

The tailboard can also be opened from the luggage compartment. To do so, press the release lever down, in the direction of the arrow, and the cover upwards »» **Fig. 115**.

## Roof carrier\*

### Introduction

The vehicle roof has been designed to optimise aerodynamics. For this reason, cross bars or conventional roof carrier systems cannot be secured to the roof water drains.

As the roof water drains are integrated in the roof to reduce air resistance, only CUPRA-approved cross bars and roof carrier systems can be used.

### Cases in which cross bars and the roof carrier system should be disassembled.

- When they are not used.
- When the vehicle is washed in a car wash.
- When the vehicle height exceeds the maximum height, for example, in some garages.

### ⚠ WARNING

- Always secure the load properly using belts or retaining straps that are suitable and in a good condition.
- Bulky, heavy, long or flat loads have a negative effect on aerodynamics, the centre of gravity and driving performance.
- Avoid sudden braking and manoeuvres.
- Adapt your speed and driving style at all times to suit visibility, weather, road and traffic conditions.

### ⚠ CAUTION

- Remove the cross bars and the roof carrier system before entering a car wash.
- Vehicle height is increased by the installation of cross bars or a roof carrier system and the load secured on them. For this purpose, check that your vehicle's height does not surpass the headspace limit, for example, for underpasses or for entering garage doors.
- Cross bars, the roof carrier system and the load secured on them should not interfere with the roof aerial or hamper the path of the panoramic sun roof and the rear lid.
- On opening the rear lid make sure that it does not knock into the roof load.

### 🌿 For the sake of the environment

When cross bars and a roof carrier system are installed, the increased air resistance means that the vehicle uses more fuel.

## Securing the crossbars and the roof carrier system

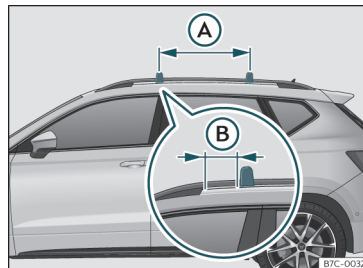

Fig. 116 Attachment points for the roof railings for the roof carrier system.

The crossbars are the basis of a series of special roof carrier systems. For safety reasons, special fixtures must be used to safely transport luggage, bicycles, skis, surf boards or boats on the roof. The appropriate accessories can be purchased at specialised CUPRA dealers or any SEAT dealership.

Always secure the crossbars and the roof carrier system properly. Always take the assembly instructions that come with the crossbars and the roof carrier system in question into account.

The crossbars are assembled on the roof railings. The distance between crossbars >>> Fig. 116 (A) should be between 70 and 90 »

cm and the distance between the crossbars and the brackets of the roof railings **B** must be 15 cm.

### WARNING

Incorrect attachment and use of the crossbars and the roof carrier system may cause the whole system to detach from the roof and cause an accident and injuries.

- Always take the manufacturer assembly instructions into account.
- Check threaded joints and attachments travelling and if necessary tighten them after you have travelled a short distance. When making long trips, check the threaded joints whenever you stop for a rest.
- Do not modify or repair the crossbars or roof carrier system.

### Note

Always read the assembly instructions that come with the crossbars and the roof carrier system carefully and keep them in the vehicle.

### Loading the roof carrier system

The load can only be secured if the crossbars and the roof carrier system are properly installed >>> .

### Maximum authorised cargo on the roof

The maximum permissible roof load is **75 kg**. This figure comes from the combined weight of the roof carrier, the cross bars and the load itself on the roof >>> .

Always check the weight of the roof carrier system, the cross bars and the weight of the load to be transported and weigh them if necessary. Never exceed the maximum authorised roof load.

If you are using cross bars and a roof carrier with a lower weight rating, you will not be able to carry the maximum authorised roof load. In this case, do not exceed the maximum weight limit for the roof carrier which is listed in the fitting instructions.

### Distributing a load

Distribute loads uniformly and secure them correctly >>> .

### Check attachments

Once the cross bars and roof carrier system have been installed, check the bolted connections and attachments after a short journey and subsequently with a certain frequency.

### WARNING

- Never exceed the maximum authorised load on the roof and on the axles or the vehicle's maximum authorised weight.

- Never exceed the load capacity of the cross bars and the roof carrier system, even if the maximum authorised roof load has not been reached.

- Secure heavy items as far forward as possible and distribute the vehicle load uniformly.

### WARNING

If the load is loose or not secured, it could fall from the roof carrier system or cause accidents and injuries.

- Always use belts or retaining straps that are suitable and in a good condition.

## Storage compartment

### Introduction

Use the storage compartments only for small or light items.

### WARNING

Objects in the driver's footwell could difficult the use of the pedals. This may cause loss of control of the vehicle and increases the risk of severe injuries.

- Make sure that nothing prevents you from using the pedals at any time.
- Always secure the mat in the footwell.

- Never place other mats or other type of covers on the factory-fitted mat.
- Ensure that no objects can fall into the driver's footwell while the vehicle is in motion.
- When the vehicle is stationary, remove the objects in the footwell.

### WARNING

If you leave lighters inside the vehicle, they might be damaged or lit inadvertently. This could lead to severe burns and damage to the vehicle.

- Before moving a seat, make sure there are no lighters in the moving part area of the vehicle.
- Before closing a storage compartment, make sure there are no lighters in the closing area.
- Never leave a lighter inside a storage compartment or any other surface of the vehicle as it could ignite due to the high temperatures on such surfaces, particularly during the summer.

### CAUTION

- Do not store heat- or cold-sensitive objects, food or medicines in the cabin. Heat and cold could damage them or render them useless.
- Objects made from transparent materials left inside the vehicle, such as glasses,

magnifying glasses or transparent suction pads stuck to the windows can concentrate sunlight and damage the vehicle.

### Glove compartment

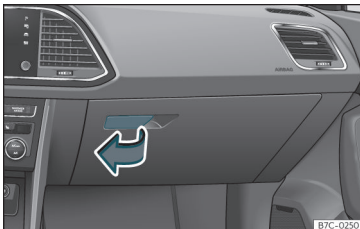

**Fig. 117** On the front passenger side: glove compartment.

Depending on the vehicle's equipment, the CD player and SD card reader are located in the glove compartment. Its operation is described in >>> page 177.

### Opening and closing the glove compartment

*Opening:* Pull the handle >>> **Fig. 117** and open the glove compartment.

*Closing:* Press the glove compartment upwards.

### WARNING

If the glove compartment is left open, the risk of causing severe injuries in the event of an accident, sudden braking or manoeuvring increases.

- Always keep the glove compartment closed while the vehicle is in motion.

### Object holder under front seats\*

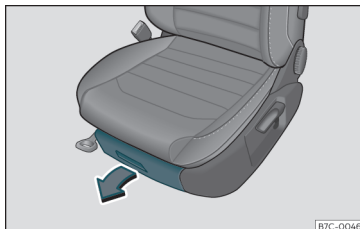

**Fig. 118** Storage compartment under the front seats.

*Opening:* Press the tab on the drawer handle and take the drawer out.

*Closing:* Push the drawer under the seat until it engages. »

### WARNING

If the drawer is left open, it could prevent use of the pedals. This may cause serious accidents and injuries.

- Always keep the drawer closed while the vehicle is in motion. Otherwise, the drawer and any objects in it could fall into the driver's footwell and obstruct the pedals.

### CAUTION

The drawer can contain 1.5 kg at most.

### Other object holders

You will find more object holders, compartments and supports in other parts of the vehicle:

- In the centre console.
- In the top of the glove compartment in vehicles that do not have a CD reader. The load of the compartment should not exceed 1.2 kg.
- Other storage compartments are found in the rear seat, to the left and the right of the seats.

There are hangers on the struts of the doors and the rear.

### WARNING

Hanging clothes may decrease the driver's visibility, which may cause serious accidents and injuries.

- Always hang clothes from hangers in such a way that the driver's visibility is not affected.
- Only hang light pieces of clothing from the hangers of the vehicle. Never leave heavy, hard or sharp objects in the pockets of these pieces of clothing.
- Do not use clothes hangers to hang up the clothing, as this could interfere with the function of the head-protection airbags.

## Drink holder

### Introduction

The storage compartments of the driver and passenger doors contain a bottle holder.

### WARNING

Incorrect use of the bottle holders may cause injuries.

- Never put hot drinks in the drink holders. In the event of sudden braking or an accident while driving, hot beverages in the bottle holders might spill and cause burns.

- Ensure that no bottles or other objects are dropped in the driver footwell while driving, as they could get under the pedals and obstruct their working.

- Never place glasses, food or other heavy objects drink holders. These heavy objects may be thrown across the cabin in the event of an accident and cause serious injuries.

### WARNING

Closed bottles may explode inside the vehicle due to cold or heat.

- Never leave closed bottles in the vehicle if the temperature inside is very high or very low.

### CAUTION

Do not leave open cans in the drink holders when the vehicle is in motion. If the drink is spilled (e.g. due to sudden braking) it may damage the vehicle and its electrical system.

### Note

The inside elements of the drink holders can be extracted for cleaning.



## Front drink holders

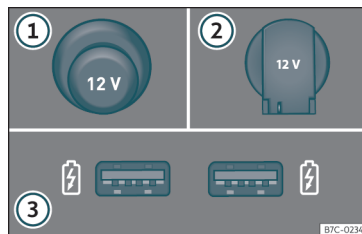

**Fig. 119** Centre console: front drinks holders.

There are two cup holders in the centre console »» **Fig. 119**.

## Power sockets

### Vehicle power sockets



**Fig. 120** Vehicle 12 volt socket.

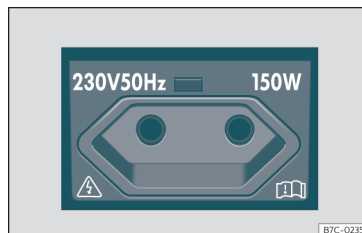

**Fig. 121** On the left side of the luggage compartment: 230 volt power socket.

12 volt power socket »» **Fig. 120**:

- ① In the centre console
- ② On the left side of the luggage compartment

- ③ In the rear part of the centre console: (USB socket).

### In the centre console

- Remove the cover from the socket, located on the centre console »» **Fig. 120** ①.
- Insert the plug of the electrical appliance into the power socket.

### In the luggage compartment\*

- Lift the power socket cover »» **Fig. 120** ②.
- Insert the plug of the electrical appliance into the power socket.

### USB power sockets

Depending on the equipment and the country, the vehicle may also have USB connections **exclusively for charging or as a power socket**.

These USB ports are located at the rear of the console, between the front seats »» **Fig. 120** ③. These connectors can work at a maximum power of up to 10.5 W per port.

They are **not** intended for file playback.

### Maximum power consumption

Power socket	Maximum power consumption
12 Volts	120 Watts



Power socket	Maximum power consumption
230 Volts	150 watts (300 watt peaks)

Electrical equipment can be connected to the 12 volt power socket.

Make sure that the maximum power consumption displayed on each outlet is not exceeded. The power consumption of devices is shown on the model plate.

When connecting two or more electrical devices at the same time, make sure that their total consumption never exceeds 190 watts >>> .

### 230 volt power socket\*

With the engine running, the power socket >>> **Fig. 121** activates automatically as soon as a connector is plugged in. If there is enough power available, the socket can still be used while the engine is off >>> .

*Connect an electrical device:* Open the cover and insert the plug into the power socket as far as possible to unlock the built-in child lock. The socket only supplies power once the child lock is unlocked.

LED on the power socket	
Steady green light:	The childproof lock is unlocked. The socket is ready to operate.

LED on the power socket	
Flashing green light:	The ignition is switched off, but there is enough power available to continue supplying the socket with current for a maximum of 10 minutes. If the connector is unplugged before this time elapses, the socket is disconnected and cannot be used again until the ignition is switched on again.
Flashing red light:	There is an anomaly, e.g. disconnection due to a current surge or overheating.

### Disconnection due to overheating

When the temperature exceeds a certain value, the 230 volt socket inverter is automatically disconnected. The disconnection prevents overheating when the power consumption of the connected devices is excessive or the ambient temperature is very high. The 230-volt power supply can be used once again after a cooling time. First unplug the connector of the connected device and then plug it back in again. This prevents the electrical device from being switched on again if this is not wanted.

 <b>WARNING</b>	
The electrical system is under high voltage!	
<ul style="list-style-type: none"> <li>Do not spill liquids onto the socket.</li> <li>Do not plug adapters or extension cords into the 230 volt power socket. Otherwise,</li> </ul>	

the integrated child lock will be unlocked and the power socket will operate.

- Do not insert conductive objects (a knitting needle, for example) into the 230 volt power socket.

### **WARNING**

The power socket works only when the ignition is on. Improper use may cause serious injury or even fire. Children should therefore not be left in the vehicle unattended if the button is also left behind. Otherwise there is a possibility that they may be injured.

### **CAUTION**

Always use the correct type of plugs to avoid damaging the sockets.

### **CAUTION**

- 230 volt power socket:
  - Do not leave devices or connectors that are too heavy (e.g. a transformer) hanging directly from the power socket.
  - Do not connect neon lamps.
  - Only connect devices to the socket if the device and socket voltage match.
  - The built-in overload disconnect function prevents any electrical devices that require a high start-up current

from turning on. In this case, unplug the electrical device's power supply and re-try the connection after about 10 seconds.

#### Note

- The use of electrical appliances with the engine switched off will cause a battery discharge.
- Should the connected appliance over-heat, immediately switch it off and disconnect it from the socket.
- Before switching the ignition on or off, unplug the appliances from the USB ports to protect them from any damage caused by fluctuations in voltage.
- Some appliances may not work properly when connected to the 230 volt sockets due to a lack of power (watts).

## Air conditioning

### Heating, ventilation and cooling

#### Introduction

The **Climatronic** cools and dehumidifies the air. They operate most effectively with the windows and the sunroof closed.

To switch a specific function on, press the appropriate button. Press the button again to switch off the function.

The LED on each control lights up to indicate that the respective function of a control has been switched on.

#### Dust and pollen filter

The dust and pollen filter with its activated charcoal cartridge serves as a barrier against impurities in the air taken into the vehicle interior.

The dust and pollen filter must be changed regularly so that air conditioner performance is not adversely affected.

If the filter loses efficiency prematurely due to use in areas with very high levels of air pollution, the filter must be changed more frequently than stated in the Service Schedule.

#### WARNING

Reduced visibility through the windows increases the risk of serious accidents.

- Always ensure that all windows are free of ice and snow, and that they are not fogged, so as to maintain good visibility of everything outside.
- Only drive when you have good visibility.
- Always ensure that you use the air conditioner and heated rear window to maintain good visibility.
- Never leave the air recirculation on for a long period of time. If the cooling system is switched off and air recirculation mode switched on, the windows can mist over very quickly, considerably limiting visibility.
- Switch air recirculation mode off when it is not required.

#### WARNING

Stuffy or used air will increase fatigue and reduce driver concentration possibly resulting in a serious accident.

- Never leave the fresh air fan turned off or use the air recirculation for long periods of time; the air in the vehicle interior will not be refreshed.

#### CAUTION

- To replace the pollen filter, always visit a service centre. »

- Switch the air conditioner off if you think it may be broken. This will avoid additional damage. Have the air conditioner checked by a specialised workshop.
- Repairs to the air conditioner require specialist knowledge and special tools. CUPRA recommends going to a specialised CUPRA Service or SEAT Official Service.

### Note

- When the cooling system is turned off, air coming from the outside will not be dried. To prevent fogging of the windows, CUPRA recommends leaving the cooling system (compressor) turned on. To do this, press

the **A/C** button. The button lamp should light up.

- The maximum heat output required to defrost windows as quickly as possible is only available when the engine has reached its normal running temperature.
- Keep the air intake slots in front of the windscreen free of snow, ice and leaves to ensure heating and cooling are not impaired, and to prevent the windows from misting over.
- The air from the vents flows through the vehicle interior and is extracted by slots in the luggage compartment designed for this purpose. Therefore, you should avoid ob-

structing these slots with any kind of object.

- Do not smoke while air recirculation mode is on, as smoke drawn into the air conditioning system leaves residue on the evaporator, producing a permanent unpleasant odour.
- It is advisable to turn on the air conditioning at least once a month, to lubricate the system gaskets and prevent leaks. If a decrease in the cooling capacity is detected, a Technical Service should be consulted to check the system.
- When the engine is under extreme strain, switch off the compressor for a moment.

## Climatronic control



Fig. 122 In the centre console: Climatronic controls.

### Automatic mode **AUTO**

Automatic adjustment of temperature, fan, and air distribution. Automatic mode is dis-

abled when the ventilation is modified manually.

### Cooling mode **A/C**

Press the button to switch on or off the cooling system.

### Temperature ①/②

The temperature of the right and left sides can be adjusted separately using the adjusters. The selected temperature is shown on the display of the climate control panel.

**Synchronisation:** press button **SYNC** so that settings on the driver's side apply to the passenger side. Use the temperature regulator for the passenger side to set a different temperature.



### Blower

The power of the fan is automatically adjusted.

The fan is also adjusted manually by turning the control.

### Air distribution

The airflow adjusts automatically for comfort. It can also be manually distributed to the desired zone by pressing the corresponding button:

-  The airflow is directed towards the chest
-  The airflow is directed towards the footwell.
-  The airflow is directed at the windscreen.

### Maximum cooling power A/C MAX

The recirculation of air and the cooling system turn on automatically and air distribution adjusts automatically to the position .

### Defrost/demist function MAX

The air drawn in from outside the vehicle is directed at the windscreen and air recirculation is automatically switched off. To defrost the windscreen more quickly, the air is dehumidified at temperatures over approximately +3°C (+38°F) and the fan runs at maximum output.

### Infotainment system: SETUP

The climate control operation and settings menu will be displayed on the Easy Connect system screen.

### Heated rear window

This only works when the engine is running and switches off automatically after a maximum of 10 minutes.

It should be switched off as soon as the glass is demisted. By saving electrical power you can also save fuel.

To avoid possible damage to the battery, an automatic temporary disconnection of this function is possible, coming back on when normal operating conditions are re-established.

### Air recirculation

>>> page 141

### Seat heating

>>> page 142

### Switching off

Press button **OFF** or manually set the fan to 0.

## Operating the Climatronic through the Easy Connect system\*

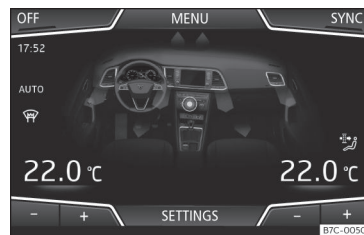

**Fig. 123** Easy Connect screen: Climate control menu.

In the Easy Connect system it is also possible to perform various adjustments to the Climatronic. »

### Open the air conditioner menu

• Press the **SETUP** button of the Climatronic control panel.

On the screen you can view and change the current settings, such as, for example, the temperature set for the driver and passenger sides. Temperatures up to +22°C (+72°F) are shown with blue arrows, and temperatures over +22°C (+72°F) with red arrows.

To switch a function on or off, or to select a submenu, you must press the corresponding function button.

#### Function button: Function

**OFF:** Climatronic is switched off.

**ON:** Climatronic is switched on.

**SYNC:** Synchronise driver and front passenger temperatures.

**SETTINGS** The air conditioning settings submenu is opened. The following settings can also be adjusted:

**Automatic supplementary heater:** to activate/deactivate the automatic activation of the auxiliary heating for colder countries (only for engines with auxiliary heating). With the option deactivated, depending on the outside temperature the heating may need more time than normal to reach a comfortable temperature.

**Automatic windscreen heating:**\* to switch the automatic windscreen heating on and off  
»» page 142.

#### Function button: Function

**Automatic air recirculation:** to switch automatic air recirculation on and off »» page 141.

**Back** : Close the submenu.

\*: It enables manual switching on or off of the windscreen heater.

: It enables activation and deactivation of the PureAir and opens the submenu.

### Climate control usage instructions

The interior cooling system only works when the engine is running and fan is switched on.

#### Economic use of the air conditioning

When the air conditioning is switched on, the compressor consumes engine power and has influence on fuel consumption.

The air conditioner operates most effectively with the windows and the panoramic sliding sunroof closed. However, if the vehicle has heated up after standing in the sun for some time, the air inside can be cooled more quickly by opening the windows and the panoramic sliding sunroof briefly.

### Change the temperature units

The temperature display can be changed from Celsius to Fahrenheit on the screen of the Infotainment system using the Infotainment button  > **Settings** > **Units**.

### The cooling system cannot be activated

If the air conditioning system cannot be switched on, this may be caused by the following:

- The engine is not running.
- The fan is switched off.
- The air conditioner fuse has blown.
- The outside temperature is lower than approximately +3°C (+38°F).
- The air conditioner compressor has been temporarily switched off because the engine coolant temperature is too high.
- Another fault in the vehicle. Have the air conditioner checked by a specialised workshop.

### Special characteristics

If the humidity and temperature outside the vehicle are high, **condensation** can drip off the evaporator in the cooling system and form a pool underneath the vehicle. This is normal and does not indicate a leak!

**Note**

After starting the engine, any residual humidity in the air conditioner could mist over the windscreen. Switch on the defrost function as soon as possible to clear the windscreen of condensation.

**Air vents**

To ensure proper heating, cooling and ventilation in the vehicle interior, the air vents must remain open.

- Turn the corresponding thumbwheel in the required direction to open and close the air vents. When the thumbwheel is in the ► position, the corresponding air vent is closed.
- Change the air direction using the ventilation grille lever.

There are other additional, non-adjustable air vents in the dash panel, in the footwells and in the rear area of the passenger compartment.



**Note**

Food, medicine and other heat or cold sensitive objects should never be placed in front of the air outlets as they may be damaged or made unsuitable for use by the air.

**Air recirculation**

Air recirculation mode prevents the ambient air from entering the interior.

When the outside temperature is very high, selecting manual air recirculation mode for a short period refreshes the vehicle interior more quickly.

For safety reasons, air recirculation mode is switched off when the button  MAX is pressed or the air distributor turned to .

**Switching the manual air recirculation mode on and off**

- Press the button  to connect or disconnect manual air recirculation.

**Automatic air recirculation mode**

With the automatic air recirculation mode activated, the entry of fresh air into the cabin interior is enabled. If the system detects a high concentration of hazardous substances in the ambient air, air recirculation mode is switched on automatically. When the level of impurities drops to within a normal range, recirculation mode is switched off.

The system is unable to detect unpleasant smells.

- Automatic air recirculation is activated and deactivated in the climate control menu >>> page 139.

The air recirculation will **not** connect automatically in versions without humidity sensor and in the following external conditions:

- The outside temperature is lower than +3°C (+38°F).
- The cooling system is switched off and the outside temperature is below +10°C (+50°F).
- The cooling system is switched off, the outside temperature is below +15°C (+59°F) and the windscreen wipers are switched on.

**WARNING**

Observe the safety warnings >>>  in Introduction on page 137.

- If the cooling system is switched off and air recirculation mode switched on, the windows can mist over very quickly, considerably limiting visibility.
- Switch air recirculation mode off when it is not required.

**CAUTION**

Do not smoke when air recirculation is switched on in vehicles with an air conditioner. The smoke taken in could lie on the cooling system vaporiser and on the activated charcoal cartridge of the dust and pollen filter, leading to a permanently unpleasant smell. »







### Note

**Climatronic:** air recirculation mode is activated to prevent exhaust gas or unpleasant odours from entering the vehicle interior when it is in reverse and while the automatic windscreen wiper is working.

### Seat heating

With the engine on, the seat cushion and the seat backrest can be heated electrically.

#### Control seat heating

- Press buttons  or  on the control panel to turn on the seat heating as high as possible.
- Press buttons  or  repeatedly to adjust it to the required level.
- To turn off the seat heating, press button  or  repeatedly until no LEDs are lit.

If the ignition is switched on again in approx. the next 10 minutes, the driver seat heating is automatically turned on to the level set the last time.

#### Cases in which the heat seating should not be switched on

Do not switch the seat heating on if any of the following conditions are met:

- The seat is not occupied.
- The seat has a cover.
- A child seat has been installed on the seat.
- The seat cushion is wet or damp.
- The outdoor or indoor temperature is greater than +25°C (77°F).

### WARNING

People who cannot perceive pain or temperature because of medications, paralysis or chronic diseases (e.g. diabetes) or have a limited perception of these, may suffer burns to the back, buttocks or legs when using seat heating.

- People with limited pain and temperature thresholds must never use seat heating.
- If an abnormality in the device's temperature control is detected, have it checked by a specialist workshop.

### WARNING

If the fabric of the cushion is wet, this can adversely affect the operation of the seat heating, increasing the risk of burns.

- Make sure the seat cushion is dry prior to using the seat heater.
- Do not sit on the seat with clothing that is wet or damp.
- Do not leave clothing that is wet or damp on the seat.
- Do not spill liquid on the seat.

### CAUTION

- To avoid damaging the heating elements of the seat heaters, please do not kneel on the seat or apply sharp pressure to a single point on the seat cushion or backrest.
- Liquids, sharps objects and insulating materials (e.g. covers or child seats) can damage the seat heating.
- In the event of smells, switch off the seat heating immediately and have it inspected by a specialised workshop.

### For the sake of the environment

The seat heating should remain on only when needed. Otherwise, it is an unnecessary fuel waste.

### Windscreen heating\*

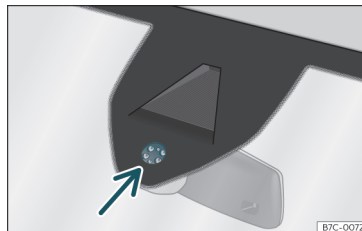

**Fig. 124** Windscreen humidity and temperature sensor.



The heated windscreen is comprised of a set of heated wires placed between the layers of the windscreen which, when electric current is supplied to them, heat up and cause the temperature of the glass to rise.

Its function is to assist the air-conditioning system to prevent the windscreen from misting up or to demist it faster if it does mist up.

The system can be switched on manually or automatically.

### Manual activation

- Press the **SETUP** button of the Climatronic control panel.
- Press the  function button to switch the windscreen heating on or off.

### Automatic activation

To facilitate use of the heated windscreen it can turn on automatically.

The Climatronic control panel can detect the danger of the windscreen misting thanks to its temperature and humidity sensors, switching the system on or off accordingly. Moreover, it will also be activated automatically when the  **MAX** button is pressed on the Climatronic control panel.

Adjust it as follows for it to switch on automatically:

- Press the **SETUP** button of the Climatronic control panel.
- Press the **SETTINGS** function button on the infotainment system.
- Switch the function on or off by pressing the **Automatic windscreen heating** function button.

## Infotainment System

### Introduction

### Safety warnings

#### Safety warnings regarding the Infotainment system

Only operate the infotainment system and its various functions when the traffic situation really permits this.

#### WARNING

- Before starting the trip, you should familiarise yourself with the different infotainment system functions.
- High audio volume may represent a danger to you and to others. Hearing may be impaired if the volume is too high, even for short periods of time.
- Changes to the Infotainment system settings should be made when the car is stopped, or by a passenger.

#### WARNING

Current traffic requires maximum attention from public road users. Distracting the driver in any way can lead to an accident and cause injuries. Operating the Infotainment

system can distract your attention from the traffic.

- Always drive carefully and responsibly.
- Select volume settings that allow you to hear sounds from outside the vehicle at all times (e.g. emergency services sirens and horns).

#### WARNING

The volume level may suddenly change when you switch audio source or connect a new audio source.

- Lower the base volume before connecting or switching audio sources.

#### WARNING

The driving recommendations and traffic indications shown on the navigation system may differ from the current traffic situation.

- Traffic signs and traffic regulations have priority over the recommendations and displays provided by the navigation system.

#### WARNING

Connecting, inserting or removing a data medium while driving can distract your attention from the traffic and cause an accident.

#### WARNING

Place the connecting cables of external equipment so that they do not interfere with the driver's mobility.

#### WARNING

External devices that are loose or not properly secured could move around the passenger compartment during a sharp manoeuvre or accident.

- Avoid placing external devices on the doors, windscreen, steering wheel, dash panel, the backs of the seats, on top of or near the area marked "AIRBAG" or between these areas and the occupants. They could cause serious injury in an accident, especially when the airbags inflate.

#### WARNING

The armrest\* must always remain closed during the journey as it could restrict the driver's movements.

#### WARNING

Opening the CD or DVD player can lead to injuries from invisible laser radiation.

- Have CD or DVD players repaired only by a qualified workshop.

### ⚠ CAUTION

The Infotainment system can be damaged by the incorrect insertion of a data storage device or the insertion of an incompatible data storage device.

- When inserting a data storage device, make sure it is correctly positioned.
- Applying force may irreparably damage the memory card slot locking mechanism.
- Only use compatible memory cards.
- When inserting and removing CDs and DVDs, always hold them at right angles to the front of the CD/DVD drive without tilting so as not to scratch them.
- If a CD or DVD is inserted while another is already in the unit or being ejected, the CD/DVD drive may be damaged. Always wait until the data medium is completely ejected.

### ⚠ CAUTION

Foreign objects stuck to a CD or DVD, or if it is not round, the player may be damaged.

- Only clean, standard 12 cm CDs or DVDs should be used.
  - Do not affix stickers or other items to the data medium. Stickers may peel off and damage the drive.
  - Do not use printable data media. Printed labels and coverings may peel off and damage the CD/DVD drive.

- Do not insert 8 cm single CDs or irregularly shaped CDs or DVDs.
- Do not insert DVD-Plus discs, Dual Discs or Flip Discs, as these are thicker than normal CDs.

### ⚠ CAUTION

The vehicle loudspeakers may be damaged if the volume is too high or the sound is distorted.

### i Note

For the proper functioning of the Infotainment system it is important that the date and time set in the vehicle are correct.

## Overview of the unit

### Navi System / Navi System Plus

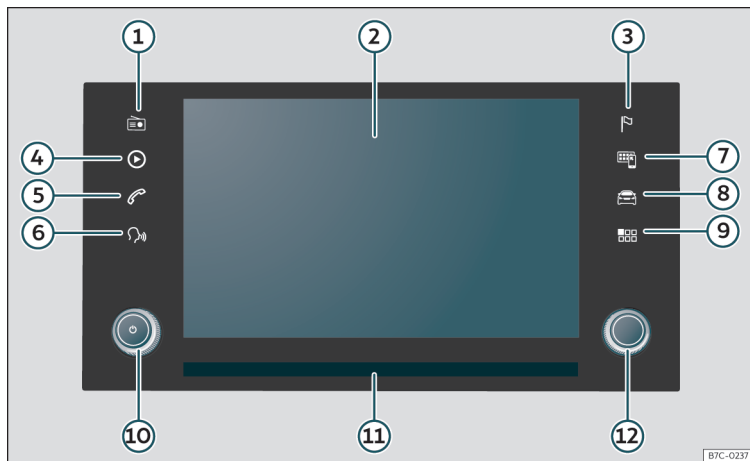

Fig. 125 Overview of the controls

- |   |   |  |
|---|---|--|
| ① Radio Mode (change of band frequency) »» page 170 | ⑥ Voice control »» page 156                 | ⑫ Settings button (search and selection) »» page 150 |
| ② Touchscreen »» page 151                           | ⑦ Full Link »» page 160                     |  |
| ③ Navigation Mode »» page 195                       | ⑧ Vehicle settings »» page 80 , »» page 209 |  |
| ④ Media mode (audio sources) »» page 177            | ⑨ Main menu »» page 150                     |  |
| ⑤ Phone Mode »» page 213                            | ⑩ Volume. Off/on »» page 150                |  |
|   | ⑪ Proximity sensor »» page 153              |  |

## Main menus

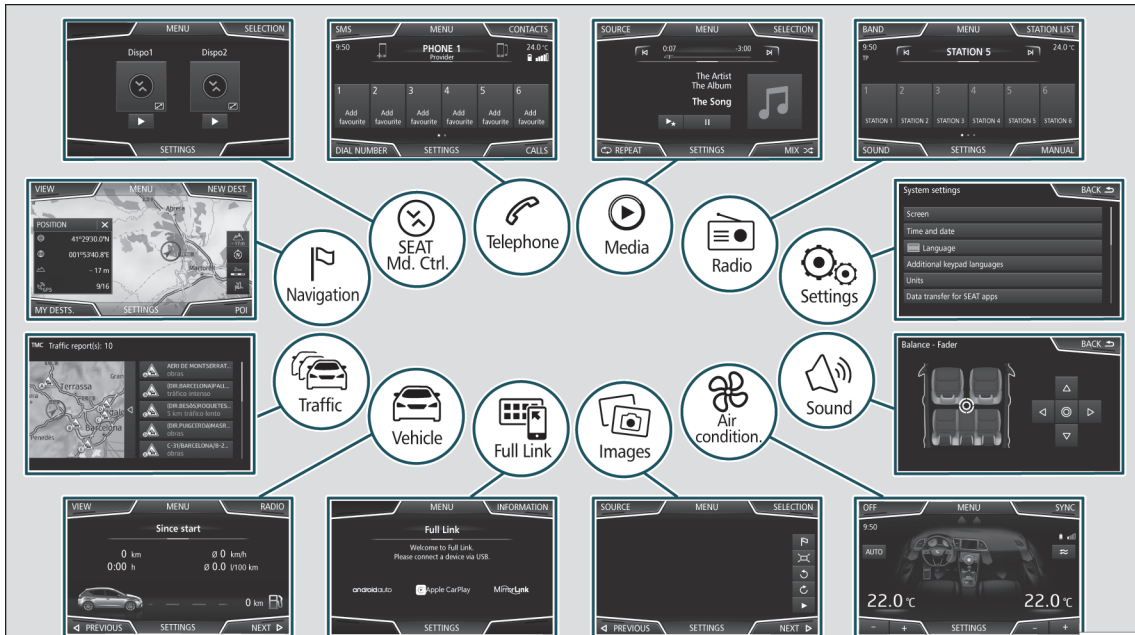

Fig. 126 Menu summary.

BRC-0003



## Radio »» page 170

- RADIO main menu »» page 170
- RDS radio data services »» page 171
- Digital radio mode »» page 172
- Memory buttons »» page 173
- Save station logos »» page 174
- Select, tune and save stations »» page 174
- SCAN automatic playback »» page 175
- TP traffic information »» page 175
- Setup »» page 176

## Media »» page 177

- Data and file formats »» page 178
- Playback order »» page 181 »» page 181
- Change the media source »» page 183
- Change track »» page 184
- Selecting an album by cover »» page 184
- Selecting a track from a track list »» page 185
- Data bank view »» page 186
- Insert or remove a CD or DVD »» page 186
- Memory card »» page 187
- External data storage device connected to the USB port »» page 187
- External audio source connected to the AUX-IN multi-media socket »» page 188
- External audio source with Bluetooth® »» page 189
- Images »» page 194
- Setup »» page 195

## Navigation »» page 195

- New destination »» page 197
- Route options »» page 198 »» page 199
- My destinations »» page 199
- Special destinations (POI) »» page 201
- View »» page 201
- Split screen »» page 202
- Map display »» page 202
- Traffic bulletins and dynamic guide »» page 203
- Predictive navigation »» page 204
- Import vCards »» page 204
- Importing Personal POI »» page 204
- Navigation with images »» page 205
- Road signs »» page 205
- Route guidance in Demo mode »» page 205
- Setup »» page 205
- Offroad mode »» page 207

## Vehicle

- Instrument panel »» page 209
- Sport »» page 210
- Offroad »» page 210
- Consumers »» page 211
- Driving data »» page 211
- Ecotrainer »» page 212
- Vehicle status »» page 213

 **Traffic** »» page 203

Traffic information (TP) »» page 175

Traffic bulletins and dynamic guide »» page 203

 **Telephone** »» page 213

Bluetooth® »» page 214

Tethering »» page 215

Function buttons »» page 216

Enter number »» page 218

Agenda »» page 219

Short messages (SMS) »» page 220

Call list »» page 221

Quick dial keys »» page 221

Setup »» page 222

 **Sound** »» page 155

 **Full Link** »» page 160

Requirements »» page 161

Activation of Full Link »» page 162

Tethering of portable devices »» page 163

MirrorLink® »» page 164

Apple CarPlay™ »» page 164

Android Auto™ »» page 165

Frequently Asked Questions »» page 166

 **Media Contr.** »» page 166

WLAN access point »» page 167

 **Images** »» page 194

 **Control** »» page 139

 **Setup** »» page 154

## General instructions for use

### Introduction

If the setup is changed, this may change the display on the screen and the Infotainment system may behave in a manner different to that described in this manual.

#### Note

- Just press a button or the screen to use the infotainment system's functions.
- The equipment's software depends on the market in question, so it is possible that not all of the function buttons or described functions are available. The equipment is not faulty if a function button is missing.
- Due to country-specific legislation, certain functions may not be available on the screen when the vehicle is travelling above a certain speed.
- Using a mobile telephone inside the vehicle may provoke noise in the speakers.
- Restrictions on the use of devices using Bluetooth® technology may apply in some countries. For further information, contact the local authorities.
- On vehicles with ParkPilot, the audio volume is automatically lowered when reverse gear is selected. The volume can be lowered in the menu **Sound > Volume**.

### Diagram of the menus



Fig. 127 Main menu

The Infotainment system touchscreen can be used to select the different main menus.

Press the Infotainment button  to open the menus summary.

The display of the touchscreen's main menu can be switched between "grid" and "carousel" and vice-versa using the menu **Settings > Screen** >>> page 154.

#### Note

Depending on the infotainment version, there may be more icons on the second page. In this case, to see the remaining icons press the function button >>> Fig. 127 (arrow) or slide your finger horizontally across the screen.

### Rotary push buttons and infotainment buttons

#### Rotary/push buttons

The left rotary push button  is the on/off button if pressed and the volume knob if turned.

The right rotary pushbutton is the search button if turned and the selection button if pressed.

#### Infotainment buttons

The Infotainment buttons are used by *pressing them or pressing and holding*.

### Switching on and off

When the system is turned on, it starts up with the volume at which it was turned off, as long as it does not exceed the preset maximum start-up volume. Select **Sound > Volume**.

The unit will switch off automatically when the key is removed from the ignition or when the on/off button is pressed (depending on the equipment fitted or the vehicle). If the Infotainment system is switched on again, it will switch off automatically after approximately 30 minutes (switch-off delay).



### Note

- The Infotainment system is a part of the vehicle. It cannot be used in any other vehicle.
- If the battery has been disconnected, the ignition must be activated before switching on the Infotainment system.

## Changing the basic volume

Increasing or decreasing the volume or muting the sound

**Raise the volume:** turn the volume control ⏻ clockwise or move the left thumbwheel on the multifunction steering wheel upward ▲.

**Lower the volume:** turn the volume control ⏻ clockwise or move the left thumbwheel on the multifunction steering wheel downward ▼.

Changes in volume are indicated by a volume bar on the screen. The volume can be controlled using the steering wheel controls. In this case, the changes in volume are displayed on the instrument panel by a volume bar.

It is possible to preset certain volume settings and adjustments. Select **≡** > **Sound** > **Volume**.

## Muting the Infotainment system sound

- Turn the volume control ⏻ anti-clockwise until it displays 🔇.
- **OR:** press the left wheel of the multifunction steering wheel.

Playback is paused while in Media mode (except AUX). The screen displays 🔇.

## Operation of the function buttons and the instructions on the screen

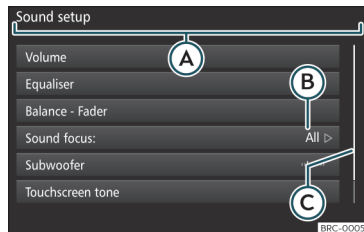

**Fig. 128** View of some of the function buttons on the screen.

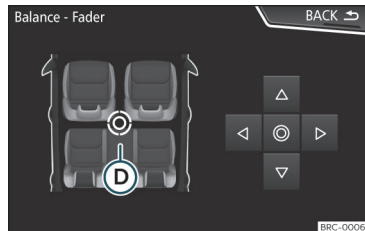

**Fig. 129** Sound setup menu

Active areas of the touchscreen that call up a certain function are called “function buttons”. These buttons are operated by *pressing them* on the screen or *holding them down*.

The function buttons appear in this manual as a “function button” and a button symbol (inside a rectangle).

These activate functions or open submenus. The currently selected menu is displayed in the title bar >>> **Fig. 128 A** of the submenus.

Inactive (grey) function buttons cannot be selected.

## Increase or decrease the size of the images displayed on the screen

The size of the navigation map image and image views can be enlarged or reduced. To do this, slide 2 fingers across the screen to separate them or bring them together. »

## Overview of screen and function buttons

### Display and function buttons: operation and effect

**(A)** The title bar shows the selected menu and other function buttons.

**(B)** Press it to open another menu.

**(C)** The scroll bar is shown on the right. Scroll the bar by sliding your finger vertically on it >>> page 152, Open list entries and search in lists.

**Movable cursor:** Move the cursor by sliding your finger across the screen.

**OR:** Press a point on the screen where you want the sound to be directed.

**(D)** **Fixed crosshair:** Press on the arrows to move the sound around according to your preferences.

**OR:** Press the central button to centre the stereo sound in the centre of the passenger compartment

 Press it on some lists to move up a level, one by one.

**BACK**  Button to return to the previous menu or move up through the folder structure.

 When pressed, a pop-up window opens (options window) which displays other set-up options.

/  Some functions are activated  or deactivated  by pressing this box.

### Display and function buttons: operation and effect

**OK** Press to confirm an entry or a selection.

**x** Press to close a pop-up window or an input window.

**+ / -** Press them to change the setup adjustments one at a time.

 Move the scroll button across the screen by sliding your finger.

## Open list entries and search in lists

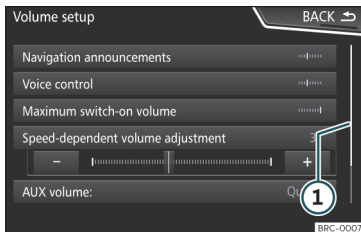

**Fig. 130** Entries on a setup menu list.

The entries on a list can be activated by pressing them on the screen or by using the settings button.

## Mark list entries using the setup button and open them

- Turn the adjustment knob to search and select from the list.
- Press the setup button to activate the marked entry on the list.

## Search lists (scrolling the screen)

The scroll bar is shown on the right and its size depends on the entries in the list >>> **Fig. 130** .

- *On the bar:* Press above or below the mark or slide your finger vertically over the mark until you reach the desired position.

## Input window with on-screen keypad



**Fig. 131** Input window with on-screen keypad.

The on-screen keypad is used for functions such as entering a memory name, selecting

a destination address or entering a search term for searching long lists.

The input line with cursor is located in the top bar of the screen. All inputs are displayed here.

### Input windows for “free text input”

In the input masks for open text, you may enter letters, numbers and characters in any combination.

### Input windows for selecting a saved entry (e.g. selection of a destination address)

It is only possible to enter a sequence of letters, numbers and characters that matches a stored entry.



Matches are suggested on the input line >>> **Fig. 131** (4). In the case of compound names, it is necessary to enter a space.

### Overview of the function buttons\*

#### Function icon and text: operation and effect

Letters and digits	Press them to copy them into the input line.
①	Press to change the keypad to another language. Keypad languages can be selected from the menu <b>System settings &gt; Speech</b> .
②	Press to show symbols on the keypad.

#### Function icon and text: operation and effect

③	If there are fewer than 99, it shows the number of entries that can be selected. Pressing opens the list according to the entry.
④	Scroll bar, the size of which depends on the number of matching entries.
⑤	If the button is held down, special characters based on that letter are displayed. Press the desired character to enter it. Some special characters can be written out instead (e.g. “AE” for “Ä”).
	Space bar
	Deletes characters on the input line from right to left. Press and hold to delete several characters.
BACK 	Close the input window.

### Proximity sensor

The Infotainment system is equipped with an integrated proximity sensor >>> **Fig. 125** (1).

The screen switches from display mode to automatic operation when your hand moves toward it. In operation mode, the function buttons are automatically highlighted to facilitate their use.

### Motion sensors (gesture control)\*

Depending on the version, the infotainment system has motion sensors that can be used to change certain functions, e.g. next station, next memory bank, previous track, etc.

- Press the infotainment key  > **Settings > Screen > activate/deactivate proximity sensor**.

If the sensors are active, when you move your hand close to the screen the silhouette of a hand will be displayed in the lower right corner.

With this function the system switches to the previous or next station, track, memory bank, etc., when you move your hand from left to right, or vice-versa, in front of the screen. An audible warning also sounds.

### Additional information and display options

The displays appearing on the screen may vary depending on the settings, and may differ from those described here.

The status bar on the screen can display, for example, the current time and outside temperature.

All displays can be viewed only after completely restarting the Infotainment system.

## Initial configuration wizard

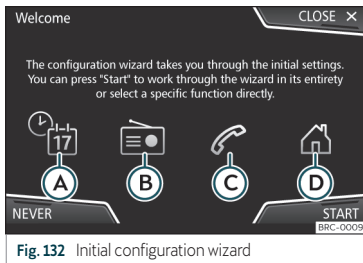

Fig. 132 Initial configuration wizard

It will help you to set up your Infotainment system the first time you switch it on.

Every time you switch on the Infotainment system, the initial setup screen will appear >>> Fig. 132 if any parameters have not been set or if the **NEVER** function button has not been pressed.

### Function button: function

<b>CLOSE</b>	Closes the Configuration Wizard, and the main menu or last mode in which you used the Infotainment system will appear.
<b>NEVER</b>	Disables the possibility of changing the settings of the Infotainment system. To configure the system go to: <b>System settings</b> and select <b>Configuration wizard</b> .

### Function button: function

<b>START</b>	Starts up the Configuration Wizard.
<b>(A)</b>	If the system includes navigation, the date and time are set automatically by the GPS.
<b>(B)</b>	Search and save the radio stations with the best reception at that time in all available bands.
<b>(C)</b>	Link your mobile phone to the Infotainment system.
<b>(D)</b>	Add your home address using your current position or by manually entering an address.
<b>PREVIOUS</b>	Previous or next parameter to configure. When a parameter has been configured, the only way to reconfigure it is by clicking on it on the main menu, not by using the Previous/Next buttons.
<b>NEXT</b>	When you configure a parameter, <input checked="" type="checkbox"/> will be displayed over it.
<b>FINISH</b>	Once one or more settings have been applied, finalise the configuration in the main menu of the wizard. If you have not set all the parameters, the Initial Configuration Wizard will start the next time you turn the Infotainment system on.

## Menu and system settings

The settings that can be selected varies depending on the country and the equipment in question, and on the vehicle's equipment.

- Press the Infotainment button and then press the **(SETTINGS)** function button.

Press the function button of the main menu or the functions for which you want to change the settings. All settings are automatically applied when the menus are closed.

### Function button: function

**(Screen)**: To change the screen settings.

**(Menu)**: To select the main menu display mode (**Mosaic** or **Carouse1**).

**(Switch off screen (in 10 seconds))**: If this function is active and the infotainment system is not used, the screen will automatically switch off after approx. 10 seconds. Pressing the screen or pressing one of the infotainment buttons will turn the screen on again.

**(Brightness)**: To select the brightness level of the screen.

**(Day / Night)**: To select the type of display (**Day**, **Night** or **Automatic**).

**(Touchscreen tone)**: The confirmation tone when a function button is pressed is active.

**(Proximity sensor)**: The proximity sensors are active. Also see >>> page 153, Proximity sensor.

## Function button: function

**Show clock in standby mode**: In standby mode, the time is displayed on the infotainment system screen.

**Date and time**: Change the time and date settings.

**Clock time source**: To select the time source (GPS or manual).

**GPS**: The time and date can be selected using the **Time zone** function button. In this case, the **Time** and **Date** function buttons for manual entry will not be active.

**Manual**: The time and date can be set manually using the **Time** and **Date** function buttons.

**Time**: To set the time manually.

**Time zone**: To adjust the desired time zone.

**Time format**: To select the time display format (12 or 24 hours).

**Date**: To set the current date.

**Date format**: To select the date display format (DD.MM.YYYY, YY-MM-DD or MM-DD-YY).

**Language**: To select the desired language for texts and phrases in the voice control system.

**Additional keypad languages**: To select additional keyboard languages.

**Units**: To set the units of measurement of the vehicle's displays: distance, speed, temperature, volume, consumption and pressure.

**Data transfer for SEAT apps**

## Function button: function

**Data transfer for SEAT apps**: This allows data to be exchanged between the vehicle and SEAT apps. They are not personal data.

**Operation via apps**: Change the level of interaction with apps.

**Deactivate**: This limits specific functions that require a higher level of security.

**Confirm**: Allows 100% of functions of the app, and certain specific actions on the Infotainment system have to be confirmed.

**Allow**: Allows all available functions to be executed from the app.

**Voice control**: To change the voice control settings >>> page 156.

**Remove safely**: To eject the data medium (SD/USB card) from the system. After correctly ejecting the data storage device from the system, the function button becomes inactive (grey colour).

**Factory settings**: When the original factory settings are restored, all **inputs and settings** that are made are **deleted**, depending on the selected settings.

**Bluetooth**: To change the Bluetooth\* >>> page 222 settings.

**WLAN**<sup>a)</sup>: To change the WLAN access point settings >>> page 192.

**System information**: Display of the system information (device number, hardware and software versions).

**Update**: To update the navigation data, do >>> page 195 **No** remove the memory card while the navigation data are being installed.

## Function button: function

**Copyright**: Information about copyright.

**Configuration wizard**: Opens the Infotainment system's initial configuration wizard.

<sup>a)</sup> Only available for the model: Navi System Plus.

## i Note

**For the proper functioning of the Infotainment system it is important that the date and time set in the vehicle are correct.**

## Volume and sound settings

The settings that can be selected varies depending on the country and the equipment in question, and on the vehicle's equipment.

- Press the Infotainment button  and then press the **Sound** function button.
- Press the main menu function button for the settings that have to be changed. All settings are applied instantly.

## Overview of screen and function buttons

## Function button: function

**Volume**: To change the volume settings.

**Warnings**: To set the playback volume of warnings, such as traffic announcements. >>

## Function button: function

**Navigation announcements**: To set the playback volume of audio driving recommendations.

**Voice control**: To set the playback volume of voice control.

**Maximum switch-on volume**: To set the equipment's maximum switch-on volume.

**Speed-dependent volume adjustment** (GALA): To set the extent to which the volume is adjusted depending on the speed. The volume of the audio will increase automatically as the speed of the vehicle increases.

**Entertainment fading when parking**: To adjust the desired reduction in audio volume when ParkPilot is active.

**Entertainment fading (nav. announcements)**: Adjusts the playback volume when the navigator is speaking.

**Volume**: To set the playback volume of audio sources connected via the AUX-IN multimedia jack (**Low**, **Medium** or **High**). Also see »» page 155, Overview of screen and function buttons.

**Bluetooth audio**: To set the playback volume of the audio sources connected by Bluetooth® (**Low**, **Medium** or **High**). Also see »» page 155, Overview of screen and function buttons.

**Equaliser**: To adjust the sound properties.

## Function button: function

**Balance - Fader**: To adjust the sound distribution. The cursor indicates the current sound distribution in the passenger compartment. To modify the sound distribution, briefly press on the desired position in the passenger compartment view or use the arrow keys for a step-by-step modification. To centre sound distribution in the passenger compartment view, press the central function button located between the arrows.

**Sound focus**: Optimizes the sound in the passenger compartment.

**Subwoofer**\*: Adjusts the volume of the subwoofer.

**Touchscreen tone**: The confirmation tone when a function button is pressed is active.

**No navigation announcements during calls**: During a telephone conversation, audio driving recommendations will not be given.

## Adjust the playback volume of external audio sources

If you need to increase the playback volume for the external audio source, first lower the base volume on the infotainment system.

If the sound from the connected audio source is **very low**, increase the **output volume** on the external audio source. If this is not enough, change the **input volume** to **medium** or **high**.

If the sound from the connected external audio source is **too loud or distorted**, lower the **output volume** on the external audio

source. If this is not enough, change the **input volume** to **medium** or **low**.

## Voice control

### How it works

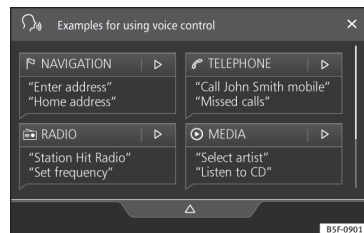



**Fig. 133** Voice control: main screen

Many of the radio, media, telephone and navigation functions can be changed by voice commands.

The voice control of the infotainment system will only be available for the language selected in *System settings* »» page 154.

- Voice control settings »» page 159.

### Start and stop voice control

- To activate voice control, briefly press the button on the multifunction steering wheel  or the infotainment system.
- When activating voice control, a dialogue start tone will sound and the main voice control screen will be displayed. >>> **Fig. 133**, (the main screen will appear in the format selected in Voice control settings >>> page 159). The spoken indications guide you through the following “dialogue”.
- Speak the desired command and follow the instructions in the “dialogue”. Often a function can be activated by different spoken commands. If in doubt, try speaking a command or say **Help**.
- When an action is taken (e.g., call a contact), the voice control ends automatically and you must activate it again if you want to continue with it. There are certain commands after which the voice control does not end, and it waits by saying **Next command?**
- To manually end voice control, press and hold the button  until the corresponding confirmation signal sounds, or briefly press the  button twice, or press the function button X in the upper right corner of the screen.
- You can also end the voice control by speaking the following commands: **Stop** or **Cancel**.





### Voice control help

It is recommended to listen to the Help the first time you use the voice control.

- Activate voice control .
- Say the command **Help** to start it in the language indicated **System Settings**, and follow the instructions in the dialogue. The **Help** command can also be spoken followed by a function of the infotainment system, such as “**Help with navigation**”.

### Interacting with the dialogue mode

Icons in upper left corner:

-  The system waits for a user's command.
-  The system has recognised a command and will act shortly.
-  The system transmits a spoken command and confirms the command that has been given.
-  The system is in paused mode. (max. 3 minutes).
-  Hide / show the voice control menu >>> **Fig. 133**.

### Operation during the dialogue

While the infotainment system transmits a spoken instruction, the symbol  will be displayed on the screen.

- You can stop the speech by pressing the upper left icon on the screen or button  and voice recognition will resume for the user.

**IMPORTANT: The system will ONLY recognize a command when the symbol  is displayed as “active” on the panel or on the touchscreen.**

If you make a mistake when speaking a command, or pronounce it incompletely and it has no effect, you may repeat the command. The symbol  remains activated.

- Briefly press button  to repeat the command.

### Voice control instructions

Follow the instructions shown below for optimal operation of the voice control.

- Speak slowly and clearly if possible. The system will not recognise words that are unclearly pronounced, or words and numbers that are missing syllables.
- Telephone numbers should be spoken digit by digit, or by blocks units, tens or hundreds.
- Speak at a normal volume, without exaggerated pronunciation or long pauses.
- Avoid outside and nearby noise (for example, conversations inside the vehicle). Close all doors, windows and the sliding sunroof. »

- Do not direct the air from the outlets towards the roof of the passenger compartment.
- If you are driving at high speed, talk a little louder.

By activating voice control the system takes you to the main screen »» Fig. 133, which will display the contexts in which the system operates and the main commands.

From here you can command the system based on the context that you want to operate, or give a voice command directly.

When selecting each of the contexts (Navigation, Telephone, Radio, Media, Voice control) a menu will be displayed listing the main commands, and providing brief explanations of how to give each of them, as a help mode.

## Voice control (RADIO)

Effect	Voice command
LISTEN TO THE RADIO	Listen to the radio
SELECT STATION	Station STATION NAME 1
	Set station
SELECT FREQUENCY	Frequency 87.9
	Set frequency
CHANGE BAND	Band FM
	Change band

## Voice control (MEDIA)

Effect	Voice command
SOURCE SELECTION	Play Jukebox <sup>a)</sup>
	Listen to CD
MUSIC SELECTION	Select track / album / artist / genre
PLAY SIMILAR TITLES <sup>a)</sup>	Play similar titles

<sup>a)</sup> Only available for the model: Navi System Plus

## Voice control (TELEPHONE)

Effect	Voice command
CALL CONTACTS	Call Name Surname Home
	Call Name Surname Mobile
CALL NUMBERS	Call 01234
	Call number
CALL LIST	Show all calls
	Missed calls
REDIAL	Redial
CALL MAILBOX	Call mailbox
SMS	Read out text message
SERVICE	Breakdown call
INFORMATION	Information call

## Voice control (NAVIGATION)\*

Effect	Voice command
ENTER THE ADDRESS	Enter address
	Guide to City, Street, number <sup>a)</sup>
SEARCH FOR SPEC. DESTINATION <sup>a)</sup>	Search for car parks
	Search for restaurants near destination
HOME ADDRESS	Home address
LAST DESTINATIONS	Last destinations
NAVIGATION TO CONTACTS	Navigate to Name Surname
	Start route guidance
ROUTE GUIDANCE	Route information

<sup>a)</sup> Only available for the model: Navi System Plus

## Voice control

Effect	Voice command
VOICE CONTROL	Pardon?
	Back
	Main menu
	Cancel voice control
	Pause voice control



Effect	Voice command
HELP	Help
	What can I say?
VOICE BUTTON	

### Note

Voice control is not available when parking

### Function button: function

**End tone in voice dialogue**: the end tone to confirm an order is deactivated.

a) Available depending on equipment

## Voice control settings

- Press the infotainment button  > **Settings** > **Voice control**.

When closing a menu, the changes will be made automatically.

### Function button: function

**Example commands (infotainment system)**: Display voice control examples on the infotainment system screen.

**Example commands (instrument cluster)**<sup>a)</sup>: Display voice control examples on the instrument panel.

**Voice control session start tone**: a signal will sound when activating voice control. Press to deactivate the signal.

**Voice control session end tone**: a signal will sound when deactivating voice control. Press to deactivate the signal.

**Input tone in voice dialogue**: the input tone to confirm an order is activated.

## Connectivity

### Data transfer

#### Introduction

This communication can allow data to be read and/or written.

From the menu **SETTINGS > Data transfer for SEAT apps**, there is a checkbox to activate/deactivate the function and a drop-down menu called **Operation via apps** which controls the level of interaction between the apps and the system.

### Full Link\*



#### Full Link technology description

The Full Link connection is made through a USB cable.

The Full Link system brings together technologies that allow communication between the Infotainment System and mobile devices:

- MirrorLink®
- Android Auto™
- Apple CarPlay™

#### Interfaces

To access the Full Link system, press the Infotainment button  or press the infotainment button  and then select the **Full Link** context.

#### WARNING

Any applications that are not suitable or execute incorrectly may cause damage to the vehicle, accidents and serious injuries.

- CUPRA recommends the use of the Apps that SEAT provides for this vehicle.
- To make full use of SEAT Apps, you must activate the **Settings > Data transfer for SEAT apps** option.
- The interaction level of the Apps on the system must be: **Allow**.
- Protect the mobile terminal with its applications from improper use.
- Never make modifications to the applications.
- Consult the instruction manual for the mobile terminal.

#### WARNING

The use of applications while driving can distract your attention from the traffic. Distracting the driver in any way can lead to an accident and cause injuries.

- Always drive carefully and responsibly.

#### CAUTION

- In areas where special regulations apply or the use of mobiles forbidden, it must be switched off at all times. The radiation produced by the mobile when switched on may interfere with sensitive technical and medical equipment, possibly resulting in malfunction or damage to the equipment.
- CUPRA cannot be held liable for any damage caused to the vehicle as a result of the use of applications that are of poor quality or are defective, the inadequate programming of the applications, the insufficient coverage of the network, the loss of data during transmission or the improper use of mobile terminals.

#### Note

- The use of Full Link technology could increase the amount you pay for data.
- CUPRA recommends having a high battery charge on the device when connected to Full Link.
- CUPRA recommends that to use Full Link, the “Date and time” should be correctly configured. Select **Settings > Date and Time**.
- SEAT apps are designed to communicate with the vehicle and interact with it through the Full Link connection.
- Information about the technical requirements, compatible devices, adapted applications and availability can be obtained at

[www.cupraofficial.com](http://www.cupraofficial.com), at specialised CUPRA dealers or any SEAT dealership.

### Is Full Link blocked?

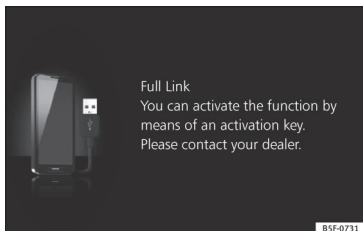

**Fig. 134** Message on Infotainment system screen.

Your vehicle does not have Full Link, you must purchase it as an accessory at your specialised CUPRA dealer or any SEAT network dealer >>> **Fig. 134**.

### Requirements for Full Link

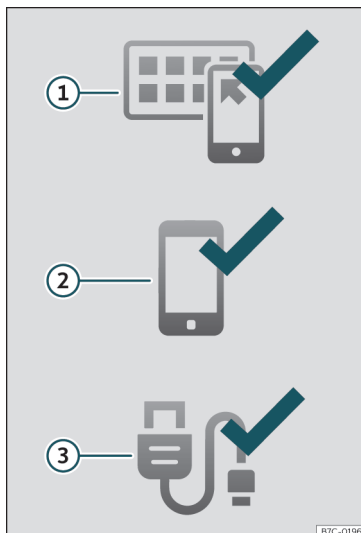

**Fig. 135** Full Link Requirements

- ① **Full Link Activated:** If you do not have Full Link in your vehicle you can acquire it as an accessory at your Authorised Service.
- ② **Compatible Phones.** Go to the MirrorLink®, Android Auto™ or Apple CarPlay™

websites to confirm whether your phone is compatible with the system.

#### Mirror Link

- Check smartphone compatibility: [www.mirrorlink.com/phones](http://www.mirrorlink.com/phones)
- MirrorLink® 1.1 or higher
- Some of the Apps certified by SEAT or the CCC must be installed in the device.

#### Android Auto

- Check smartphone compatibility. Android Auto™: [www.android.com/auto/](http://www.android.com/auto/)
- Android 5.0 (Lollipop) or higher
- Install Android Auto™ app

#### Apple CarPlay

- Check smartphone compatibility. Apple CarPlay™: [www.apple.com/ios/carplay](http://www.apple.com/ios/carplay)
- iPhone 5 or higher and iOS 7.1 or higher
- Turn on the SIRI personal assistant (see phone settings)

- ③ **USB cable connecting car to phone:** Use the approved USB cable supplied with the phone.

## Activation of Full Link

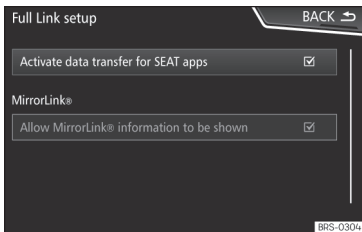

Fig. 136 Full Link Setup

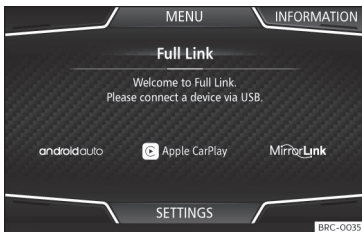

Fig. 137 Full Link menu

Data connection via Wi-Fi or SIM is not necessary to establish the connection between the smartphone and Full Link.

Data connection via Wi-Fi or SIM is necessary to enable all of the app features<sup>1)</sup>.

Proceed as follows to use Full Link:

- Switch on the Infotainment system
- Connect the smartphone to the vehicle's USB port using a USB cable >>> page 224.
- In the main menu for the Full Link setup, select **Activate data transfer for SEAT apps** >>> Fig. 136.

Finally, a message will appear stating that data transfer will commence when the device is connected. Please note that data is transferred over connections between your vehicle and mobile device. Press **OK**. Once selected, the technology compatible with your device can be used.

### Note

Depending on your smartphone, it may have to be unlocked for the connection to occur.

## What should I do if it does not connect?

Restart the mobile device.

**Check the USB cable.** Check whether the USB cable is damaged. Check that neither connection (USB/micro USB) is damaged or worn.

**Check that the USB ports are correctly connected.** Check that the USB port of the vehicle and the device are not damaged and/or deteriorated.

- Clean the USB ports (device and vehicle).
- Try with another compatible mobile device.
- Have the USB port replaced at an authorised dealership.
- Have the mobile device repaired or replace it.

<sup>1)</sup> Using the data connection to transfer the smartphone apps to Full Link may involve additional charges. Please check the charges with your operator.

## Tethering of portable devices that support MirrorLink®, Android Auto™ and/or Apple CarPlay™ technologies



Fig. 138 Full Link menu

When you enter Full Link for the first time, the technologies available for pairing the portable device are displayed.

Once the device connects via USB, the system will offer you the technologies available for establishing a connection.

In the event of simultaneous connections between two devices with different operating systems, a choice will be presented for which one to make the connection with >>> **Fig. 138.**

<sup>1)</sup> Unless the device requires the screen to be unlocked in order to establish the connection.

### View of the device list

iPhone™ devices only support Apple CarPlay™.

There are some Android devices that support MirrorLink® and Android Auto™.

Bear in mind that once the device is connected it will not be available as an audio source.

### Full Link Settings

#### Function button: function

(Activate data transfer for SEAT apps): allows the exchange of information between the vehicle and applications authorised by SEAT.

### Last Mode

If the telephone connection is terminated only by unplugging the cable, the next time the device is connected, the session will start without the user having to take any action<sup>1)</sup>.

### Information

Consult the mobile device manual.

Depends on each technology:

1. Availability in a country
2. Third party applications

### For further information:

MirrorLink®:  
www.mirrorlink.com

Apple CarPlay™:  
www.apple.com/ios/carplay

Android Auto™:  
www.android.com/auto

#### **i** Note

- In order to use Android Auto™ technology it is necessary to download the Android Auto™ application, located on Google Play™.
- Only compatible applications can be used, in accordance with the technology connected.

## MirrorLink®



Fig. 139 Function buttons in the general view of compatible applications.



Fig. 140 Other MirrorLink function buttons.

MirrorLink® is a protocol which enables communication between a device and the Infotainment system.

This makes it possible to display and operate content and functions on the device from the screen of the infotainment system.

To avoid distracting the driver while driving, only specially adapted applications can be used >>> [△](#) in Full Link technology description on page 160.

### Requirements

In order to use MirrorLink®, the following requirements must be met:

- The device must be compatible with MirrorLink®.
- Depending on the device that is used, a suitable application must be installed for the use of MirrorLink®.

### Initiating the connection

- In order to initiate the connection with the device, just connect it to the Infotainment system via the USB cable.
- A pop-up screen will appear, which will request that you accept the device.

### Function buttons and possible messages

#### Function button: function

FULL LINK	To return to the Full Link main menu.
CLOSE APPS	Press to close the open apps. Then press the apps to be closed or the <a href="#">Close all</a> function button to close all the open applications.

#### Function button: function

1 : 1	Press to change to the mobile device screen.
SETTINGS	To open the Full Link setup
>>> Fig. 140 ①	Press to return to the MirrorLink® main menu.
>>> Fig. 140 ②	Press to display all the function buttons in the lower or upper right-hand margin of the screen.
>>> Fig. 140 △ / ▷ OR: Right adjustment button	Allows buttons ① and ② to be hidden or shown.

### MirrorLink® setup

#### Function button: function

[Activate MirrorLink pop-up windows](#): Allows MirrorLink® pop-up windows in applications that support it.

### Apple CarPlay™\*

✓ Valid for compatible iPhone™ mobile telephones. Also, iPhone™ mobile telephones only support Apple CarPlay™

Apple CarPlay™ is a protocol which enables communication between a device and the infotainment system.

This makes it possible to display and operate content and functions on the device from the screen of the infotainment system.

## Requirements

In order to use Apple CarPlay™, the following requirements must be met:

- Make sure that you do not have Apple CarPlay™ restricted on your device, at: **Settings > General > Restrictions > CarPlay > ON.**
- The mobile device must be compatible with Apple CarPlay™.

## Initiating the connection

In order to initiate the connection with the device, just connect it to the Infotainment system via the USB cable.

- A pop-up screen will appear, which will request that you accept the device.
- If you start the session using Apple CarPlay™ technology, it will not be possible to pair another device via Bluetooth®. The following message will appear in the main *Phone* menu:

**Please disconnect Apple CarPlay first to connect a different mobile phone.**

Holding down the  button will start the Apple™ voice “engine”.

To return to the basic contents of the Infotainment system, press the **SEAT** icon.

## Android Auto™\*

- ✓ Valid for compatible Android mobile phones.

Android Auto™ is a protocol which enables communication between a device and the infotainment system.

This makes it possible to display and operate content and functions on the device from the screen of the infotainment system.

## Requirements

In order to use Android Auto™, the following requirements must be met:

- The mobile device must be compatible with Android Auto™.
- The Android Auto™ application should already be downloaded and installed on the mobile device.

## Initiating the connection

In order to initiate the connection with the device, just use the USB cable to connect it to the infotainment system and follow the instructions on the device to be paired.

- The first connection to Android Auto™ must be done while the vehicle is stationary.
- Once the first pop-up window about accepting data transfer between the car and the device has been accepted, a message will appear requesting that you check your

mobile device for the confirmations needed to pair it with the Infotainment system.

- If you are starting the session using Android Auto™ technology, the device also automatically connects to the Infotainment system via Bluetooth® and it will not be possible to pair another device via Bluetooth®.

Holding down the  button will start the Android™ voice “engine”.

To return to the basic contents of the Infotainment system, press the  button.

### Note

**Some devices require a change in the USB connection mode in order to use Android Auto™.**

- **Make sure that your device is in “Media Transfer Protocol (MTP)” mode before it is connected to the Infotainment system.**

### Note

**Android Auto™ requires the use of Google™ services, as well as certain basic applications of the Android system.**

- **Make sure that you always have Google™ services updated in order to use this technology.**

## Frequently asked questions about Full Link

### What connection method is used?

USB Cable.

### Will the USB cable be supplied with the vehicle?

No. The USB cable supplied with the device should be used.

### Is it possible to navigate?

Navigation is possible in each one of the Full Link technologies if the technology is available in your country and if you have the Navigation app.

### What is the difference between using the Full Link system navigator (via a device) instead of another navigator?

Advantages: Daily updates.  
Issues: data consumption, reception problems.

### Can I send voice messages?

With certified applications, you can reply, not send.

### What applications will be visible while driving?

Depending on the technology:  
– for MirrorLink®: Apps certified by SEAT and the CCC,  
– for Android Auto™: Apps selected by Google™,  
– for Apple CarPlay™: Apps selected by Apple™.

### Where can I find compatible Apps?

Compatible apps are listed at the following links:  
[www.mirrorlink.com/](http://www.mirrorlink.com/)  
[www.android.com/auto/](http://www.android.com/auto/)  
[www.apple.com/ios/carplay/](http://www.apple.com/ios/carplay/)

### Where can I download the apps?

On Google Play™ for Android Auto™/MirrorLink® and on Apple Store™ for Apple CarPlay™.

### If Full Link stops working, where can I go to repair it?

If the problem is in the car, you should go to the dealer.  
If the problem is in the mobile device, you should see your mobile telephone vendor.

### Will WhatsApp be certified?

The WhatsApp situation depends on the technology.

### Is MirrorLink® available in my country?

Yes, MirrorLink® is available in all countries and regions where CUPRA is located.

### What are the differences between MirrorLink®, Android Auto™ and Apple CarPlay™?

MirrorLink® is not compatible with Android Auto™ and Apple CarPlay™, as they are different technologies. They all coexist in Full Link, although Android Auto™ is designed for mobile devices with the Android™ operating system, and Apple CarPlay™ for iPhone.

### Can MirrorLink® be installed in a previous CUPRA model?

No, it is not possible.

### Where can I find more information about Full Link?

If you have any questions, please see our *Innovation/Connectivity* sections on our website: [www.seat.es](http://www.seat.es) or [www.seat.com](http://www.seat.com) or e-mail [seat-respond@seat.es](mailto:seat-respond@seat.es)

## Media Control\*

### Introduction

The **Media Control**<sup>1)</sup> app can be used to remotely operate some partial functions in *Radio*, *Media* and *Navigation* mode. Information can be exchanged between a device and the Infotainment System.

The functions are operated by means of a Tablet or partially by a mobile phone.

### Operating requirements:

- A tablet or mobile phone.
- The app must be available on the corresponding device.

<sup>1)</sup> Availability depends on the country.



- There must be a WLAN connection between the Infotainment System and the device. Select **Menu > Media > Settings > WLAN > Share connection over WLAN > Configuration**.

Make sure that data transfer for apps is activated:

- From the SETTINGS menu > **Data transfer for SEAT apps**, there is a checkbox to activate/deactivate the function and a drop-down menu called **Operation via apps** which controls the level of interaction between the apps and the system. Select **Menu > Settings > Transfer data from mobile devices**.

You can obtain information about the technical requirements in the CUPRA website, in specialised CUPRA dealers or any SEAT dealership.

Telephone functions do not form part of this app.

## Data transmission and control functions



Fig. 141 Media Control Main menu

With **Media Control** you can operate the Infotainment System from other seats in the vehicle in *Radio* and *Media* modes and, depending on the country and the equipment, you can switch the following information between a device and the Infotainment system:

- Navigation destinations.
- Traffic information.
- Social media contents.
- Audio transmission.
- Vehicle data.
- Location-specific information, for example, POIs.

## WLAN access point\*

### Introduction

The Infotainment System can be used to share a WLAN connection with up to 8 devices >>> page 168, Configuration for sharing a connection over WLAN.

The Infotainment System can also use the WLAN hotspot of an external device to provide Internet to the devices connected to the hotspot (WLAN client) >>> page 168, Configure Internet access.

### Note

- **Data transmission may incur charges.** Due to the high volume of data exchanged, CUPRA recommends the use of a flat rate tariff for data transmission. Mobile phone operators can provide the relevant information.
- **The exchange of data packages may generate additional costs, depending on your mobile phone rate, particularly if you are abroad (for example, roaming rates).**

## Configuration for sharing a connection over WLAN

### Establishing the connection with the wireless network (WLAN)

- Press the Infotainment button  and then press the **Settings** menu.
- Activate the wireless network. To do so, press the **WLAN** function button.
- Activate the wireless network (WLAN) on the device that is to be connected. If necessary, refer to the manufacturer's instruction manual.
- Activate the mobile device assignment on the Infotainment System. To do so, press the **Enable WLAN connection** button and activate the checkbox.
- Enter and confirm the network key displayed on the device.

The following settings can also be made on the menu **Share connection**:

**Security level:** WPA2 encryption automatically generates a network key.

**Network key:** Network key automatically generated. Press the function button to manually change the network key. The

network key must have a minimum of 8 characters and a maximum of 63.

**SSID:** WLAN Network name (maximum of 32 characters).

**Do not send network name (SSID):** Activate the checkbox to deactivate the visibility of the wireless (WLAN) network.

The wireless (WLAN) connection is established. To complete the connection, it may be necessary to enter other data into the device.

Repeat this process to connect other devices.

### Wi-Fi Protected Setup (WPS)<sup>1)</sup>

*Wi-Fi Protected Setup* can be used to create a ciphered local wireless network quickly and simply.

- Establish the connection with the wireless network (WLAN) >>> page 191.
- Press the WPS button on the WLAN router until the warning light on the router starts flashing. If the WLAN router does not support WPS the network must be configured manually.

• **OR:** Press and hold the WLAN button on the WLAN router until the WLAN light on the router starts flashing.

• Press the WPS button on the WLAN device. The wireless (WLAN) connection is established.

Repeat this process to connect other devices.

### Configure Internet access

The Infotainment System can use the WLAN hotspot of an external device to establish an internet connection.

### Establishing the connection with the wireless network (WLAN)

- Activate and check the wireless hotspot on the external device. If necessary, refer to the manufacturer's instruction manual.
- Press the Infotainment  button and then press the **Settings** menu; **OR** access *Media* or *Media Control* mode and press the **SETTINGS** menu.
- Press on the menu **WLAN > Enable WLAN connection** and check the verification box.

<sup>1)</sup> This function depends on the equipment and the country in question.

- Press the **Find** function button and select the device you want from the list.
- If necessary, enter the network key of the device in the Infotainment System and confirm with **OK**.

*Manual settings:* To manually enter the network settings of an external (WLAN) device.

The wireless (WLAN) connection is established. To complete the connection, it may be necessary to enter other data into the device.

### Note

**Due to the large number of devices on the market, it is not possible to guarantee fault-free operation of all functions.**

## Operating modes

### Radio

#### RADIO main menu





Fig. 142 RADIO main menu.



Fig. 143 Radio mode: station list (FM).



Press the infotainment button  to open the Radio main menu >>> Fig. 142.

#### RADIO main menu function buttons

Function button: function	
	Memory buttons (1 to 18 memories, 3 banks (screens) >>> page 173)
<b>BAND</b>	Select the band.
<b>STATION LIST</b>	List of radio station that can be tuned.
<b>MANUAL</b>	Selecting the frequency manually.
<b>VIEW</b>	Selecting the information shown on the screen. Only available in DAB mode.
<b>SETTINGS</b>	Settings menu for the current frequency band.
	Previous or next station that is stored or on the station list. See Settings >>> page 176.
<b>Scan</b>	Stops the station search (visible only if it is running >>> page 176).

#### Indications and possible icons

Display: Meaning	
	Frequency or name of the station or radio text. The name of the radio station and the radio text will only be displayed if RDS is active.
<b>RDS off</b>	The RDS radio data service is deactivated.

Display: Meaning	
<b>TP</b>	Traffic information can be retrieved: select <b>Radio &gt; Settings &gt; Traffic station (TP)</b> .
	No stations with traffic news are available.
	The radio station is stored on a memory button.

Note	
	<ul style="list-style-type: none"> <li>The AM and DAB bands will be available according to countries and/or equipment. In this case, the BAND function button will not be displayed.</li> <li>Being underground, in tunnels, in areas with tall buildings or mountains can interfere with the radio reception.</li> <li>Foil or metal-coated stickers attached to the windows may affect reception on vehicles with a window aerial.</li> <li>Radio stations are responsible for the content of the information they transmit.</li> </ul>

## Radio data services RDS (FM band)

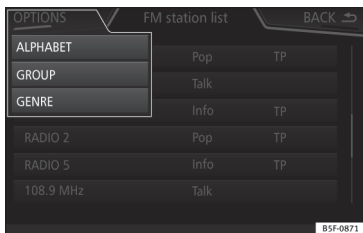

Fig. 144 Standard representation: FM station list-menu

The RDS (Radio Data System) or radio data service offers additional FM information such as the display of the station name, automatic station tracking (AF), texts broadcast by radio (Radio text), traffic announcements (TP) and the type of station (PTY).

Depending on the country and the equipment in question, RDS can be deactivated in the **FM Settings** menu »» page 176.

In general, no **radio data services** are available **without RDS**.

## Station name and automatic station tracking

If the RDS function is available, the names of the stations can be displayed on the **RADIO** main menu and on the **Station List**.

FM stations temporarily or permanently broadcast different contents on different regional frequencies under the same name (for example, Station 3).

In general, automatic station tracking takes charge of switching to the frequency with the best reception of the station that is tuned at any given time, while driving. However, this may cause a regional broadcast to be interrupted.

Automatic frequency switching and automatic station tracking can be deactivated in **FM Settings** »» page 176.

## Set a station name

In certain cases the station name is excessively long. This text can be locked / unlocked by pressing on the name of the station for about 3 seconds until an audible warning is heard (a point will flash to the right and left of the station name).

## Radio text

Some stations that have RDS transmit additional information in text, the so-called radio text.

The radio text is displayed in the upper half of the screen above the memory buttons »» Fig. 142 (A).

The radio text display can be deactivated in the **Settings** »» page 176.

## Order of the station list

The stations available at any given time are displayed on the station list screen (**STATIONS** function button). This list can be sorted by broadcast group, genre or alphabetically »» Fig. 144.

## Note

The RDS functionality will be limited in some countries for infrastructure reasons, and traffic announcements (TP), automatic station tracking (AF) and station type (PTY) may not be available.<sup>1)</sup>

<sup>1)</sup> Depends on the market and unit in question.

## Digital radio mode (DAB, DAB + and DMB audio)\*



Fig. 145 Display of memory buttons in DAB mode.



Fig. 146 Station information display in DAB mode.

The DAB radio tuner supports the DAB, DAB + and DMB audio transmission standards.

In Europe, digital radio is transmitted over band III frequencies (from 174 MHz to 240 MHz).

The frequencies are called “channels” and have an abbreviation (eg 12 A).

In a channel, several available DAB stations are grouped together in an “ensemble”.

### Starting the Digital radio mode

- In the **RADIO** main menu, press the **BAND** function button and select **DAB**.

The last DAB station that was selected will be played, if it can still be tuned in that location.

The selected DAB station is displayed in the top bar of the screen, the group of selected stations is shown below »» Fig. 145.

### Additional DAB stations (Secondary Service Components)

Some DAB stations temporarily or permanently offer **additional stations** (for example, for the transmission of sporting events).

DAB stations containing additional stations are identified on the station list by the symbol ▶.

### Select additional stations

Press the name of the main station on the DAB main menu to select an additional station. Or, select the additional station from the station list.

On the DAB main menu, the name of the additional tuned station is displayed next to the abbreviated name of the main DAB station.

Additional stations can not be saved.

### Automatic station tracking

DAB radio is not currently available everywhere. DAB radio mode displays the areas without DAB coverage 📶.

If the DAB station that is being listened to can no longer be tuned (e.g. there is no DAB coverage), the infotainment system tries to find and tune the same station in the different available frequency bands. If the station can not be found again, the radio sound is muted. Automatic station tracking can be activated in the DAB Settings in the following modes »» page 177:

- **DAB - DAB station tracking:** The radio tries to tune to the same station on an alternative DAB frequency. To allow station tracking, both DAB stations need to broadcast the same station identification, or to signal the other corresponding DAB station through DAB.
- **DAB - FM Automatic switching:** The radio tries to tune to the same station in the FM frequency band. To allow station tracking, the DAB station and the FM station need to broadcast the same station identification, or to signal the other corresponding FM station through DAB. When the corresponding FM

station has been found, “FM” is displayed behind the name of the station. If the corresponding DAB station becomes available again, it returns to DAB mode after a while and the “FM” identification is concealed.

- **Switch to a similar station:** This allows service providers to indicate alternative stations with similar content. In this way, if the radio loses coverage of a DAB station and does not find an alternative FM or DAB frequency, it is possible to tune to a station with similar content.

### Radio text

Some stations transmit additional text information, the so-called radio text.

Radio text is displayed in the upper half of the screen above the memory buttons >>> **Fig. 145** or on the Station Information or Radio text screens of the **Display** menu >>> page 173.

The radio text display can be deactivated in the DAB Settings >>> page 177.

### Slideshow

Some stations transmit additional visual information in the form of images.

These images are displayed as a slideshow on the **Stations** or **Slideshow** screens of the **Screen** menu >>> page 173.

The slideshow can be displayed in full screen by pressing on the current image.

### Screen Menu

The function buttons refer to the menu that is displayed when the **View** button is pressed >>> **Fig. 145**.

#### Function button: function

**Preset list:** Viewing the preset buttons >>> **Fig. 145**.

**Station List:** Simultaneous display of radio text and slideshows instead of memory keys >>> **Fig. 146**.

**Radio text:** The radio text is displayed instead of the memory buttons.

**Slideshow:** Slideshows are shown in full screen mode.

#### **i** Note

**Not all DAB stations broadcast radio text and slideshows.**

## Memory buttons



**Fig. 147** RADIO main menu.

In the *Radio* main menu, you can store stations from all available frequency wavelengths on the numbered function buttons. These function buttons are called “memory buttons”.

### Storing the station on the memory buttons

See: Preset stations >>> page 175.

### Change the memory bank (screens)

- Move your finger over the screen from left to right or vice-versa.
- **OR:** Press one of the function buttons >>> **Fig. 147** **A** »

## Selecting the station from the memory buttons

- Press the memory button corresponding to the desired station.

The stored stations can only be played by pressing the corresponding memory button provided it can be received at your current location.

## Storing the station logo on the memory buttons

Saved stations can be assigned logos >>> page 174.

## Save station logos

### Save automatically (only in FM and DAB mode)

When a station is saved, the station logo is automatically assigned.

If there are 2 or more logos in the database, there is the option to choose the appropriate one.

### Saving manually

Station logos can be imported from a compatible data medium (for example, memory card or memories with a USB port).

- Press the function button **Settings** and then **Station logos**.
- Press the stored station button that you want to use to store a station logo.
- Select the source in which the logo has been memorized (for example, **SD Card 1**). It is recommended that the logos should be put in the root directory of the memory unit.
- Select the station logo.
- Repeat the process to assign other logos; press the infotainment button **☰** to return to the Radio main menu.
- If you want to change the logo of a memory button where a button has already been saved, it must first be deleted from the button in question.

### Note

**Not all stations are in the database, so it is not always possible to assign logos automatically.**

## Select, tune and save stations

### Selecting stations

Select the station using the arrow keys

Press the function button **⏪** or **⏩** >>> **Fig. 142**. This switches between stations available for tuning >>> page 176.

### Selecting stations

Selecting stations from the station list

Press the **Stations** >>> **Fig. 142** function button to open the station list.

Browse the list and tune to the station you want by pressing it.

Press the **BACK** >>> **Fig. 143** function button to close the list. If it is not used, the list will close automatically after a while.

### Manually tuning a station frequency

Display the frequency band

Press the **Manual** function button >>> **Fig. 142**.

Changing the frequency step by step

Turn the adjustment knob.

**OR:** Press the **+** or **-** keys on the dial displayed on the screen.

Quickly track the frequency band

Press and hold one of the arrow buttons on the left of the multifunction steering wheel. Releasing the button switches to the next radio station that can be tuned.

**OR:** Keep your finger on the scroll button in the frequency band and move your finger to move the button.

Hide the frequency band

Briefly press the settings button.

Selecting a station using the memory button also ends the manual selection of frequencies. If no operations are performed, the frequency band is hidden after a while.



## Presetting stations

Saving the station that is being listened to.	<p>Press and hold the desired preset button &gt;&gt;&gt; Fig. 142 until an audible signal is heard.</p> <p>The tuned station is stored on a preset button.</p>
Saving a station from the stations list	<p>Press the (Stations) &gt;&gt;&gt; Fig. 142 function button to open the station list.</p> <p>The stations that are already stored on a memory key are marked on the station list with the symbol ☆ &gt;&gt;&gt; Fig. 143.</p> <p>Select the desired station by pressing and holding it down on the screen. A screen opens for saving the station on the memory buttons.</p> <p>Press the memory key where the station will be saved.</p> <p>A sound is heard and the station is saved on the memory button. Repeat the process to continue saving other station on the list.</p>
Delete preset stations	<p>The Settings menu can be used to delete all of the saved stations together, or separately &gt;&gt;&gt; page 176.</p>

## Automatic playback (SCAN)

When automatic playback is active, all tuneable stations in the selected frequency band are played for approximately 5 seconds each.

## Start and end automatic playback

Start automatic playback	<p>Press the (Settings) function button and then select (Scan).</p>
End automatic playback	<p>Press the (SCAN) function button to stop automatic playback on the station that is being played.</p> <p>Automatic playback also ends when a station is selected manually using the memory buttons, or when the screen is changed.</p>

## Traffic information (TP)

It is only possible for traffic information to be tracked with the TP function if the station in question can be tuned. Stations with the traffic information function are shown on the RADIO main menu and on the station list with the symbol TP >>> Fig. 142 and >>> Fig. 143.

Some stations without their own traffic information support the TP function by broadcasting traffic announcement from other stations (EON).

### Activating and deactivating the TP function

- In the Settings (FM, AM, DAB) menu, activate  or deactivate  the (Traffic programme (TP)) function button by pressing it >>> page 176.

## Active TP function and station selection

Traffic announcements are played in Audio mode.

If a station without the TP function in FM mode is selected, the radio tries to find stations with this function in the background. If none are found, it will be displayed half way up the left hand side of the screen .

In AM mode or in Media mode, a traffic station is automatically tuned in the background as long as there is one available. Depending on the situation this operation may take some time.

### Incoming traffic announcement

In Audio mode, traffic announcements are played automatically when they are received.

While the traffic announcement is playing, a pop-up window is displayed and the radio switches, if necessary, to the traffic information station.

Media mode is interrupted and the volume is set as adjusted >>> page 155.

The volume of the traffic announcement can be changed with the volume control . The modified volume remains as set for subsequent warnings.

- Press the (Cancel) function button to end the current travel warning. The TP function remains active.

- **OR:** Press the **Deactivate** function button to end the current traffic announcement and deactivate the **TP** function permanently. The function can be reactivated in the **Settings** menu.

## Settings (FM, AM, DAB)

### FM settings

Select the **FM** frequency band by pressing the infotainment key .

**OR:** Press the **BAND** function button and select the **FM** frequency band.

Press the **SETTINGS** function button to open the **FM settings** menu.

### Function button: function

**Sound**: Sound settings >>> page 155.

**Scan**: Automatic playback (SCAN function). When automatic playback is active, each of the tuneable stations in the selected frequency band are played for approximately 5 seconds each >>> page 175.

**Seek mode**: To set the settings for the arrow buttons **K** and **D**. The setting applies to all frequency bands (FM, AM and DAB).

**Preset list**: The arrow keys are used to switch between all of the saved stations in the selected frequency band.

### Function button: function

**Station List**: The arrow keys are used to switch between all of the tuneable stations in the selected frequency band.

**Traffic programme (TP)**: The TP function (tracking of traffic information stations) is active >>> page 175.

**Delete presets**: To erase all or some of the preset stations.

**Station logos**: To assign or delete manually the station logos saved in the memory keys >>> page 174.

**Radio text**: The radio text is active >>> page 171, Radio text.

**Advanced settings**<sup>a)</sup>: Radio data services (RDS) settings.

**Autostore station logos**<sup>a)</sup>: The stations saved on the memory buttons are automatically assigned radio station logos if they are available in the infotainment system. Also see >>> page 174.

**Station logo region**<sup>a)</sup>: This allows the vehicle's region (country) to be selected. This optimizes the automatic assignment of station logos. The option also allows the system to select the region automatically.

**Automatic frequency control (AF)**<sup>a)</sup>: Automatic station tracking is active. When there is no check in check box , the function button **RDS regional** will be inactive (grey).

**Radio data system (RDS)**<sup>a)</sup>: The Radio Data System (RDS) is deactivated >>> page 171. If there is no check in check box , the traffic information station (TP), radio text, station name and program type functions will not be available.

### Function button: function

**RDS regional**<sup>a)</sup>: Set the **RDS automatic station tracking** >>> page 171.

**Fixed**: Only alternative frequencies of the set station with an identical region program are set.

**Automatic**: It always changes to the frequency of the set station that has the best signal at the time, even if a regional broadcast that is in progress is interrupted.

<sup>a)</sup> This depends on the country and unit in question.

### AM settings

Select the **AM** frequency band by pressing the infotainment button .

**OR:** Press the **BAND** function button and select the **AM** frequency band.

Press the **SETTINGS** function button to open the **AM settings** menu.

### Function button: function

**Sound**: Sound settings >>> page 155.

**Scan**: Automatic playback (SCAN function). When automatic playback is active, each of the tuneable stations in the selected frequency band are played for approximately 5 seconds each >>> page 175.

**Seek mode**: To set the settings for the arrow buttons **K** and **D**. The setting applies to all frequency bands (FM, AM and DAB).

### Function button: function

**Preset list**: The arrow keys are used to switch between all of the saved stations in the selected frequency band.

**Station List**: The arrow keys are used to switch between all of the tuneable stations in the selected frequency band.

**Traffic programme (TP)**: The TP function (tracking of traffic information stations) is active >>> page 175.

**Delete presets**: To erase all or some of the preset stations.

**Station logos**: To assign logos to stations stored on memory buttons >>> page 174.

### DAB settings

Select the **DAB** frequency band by pressing the infotainment button .

**OR**: Press the **(BAND)** function button and select the **DAB** frequency band.



Press the **(SETTINGS)** function button to open the **DAB settings** menu.

### Function button: function

**Sound**: Sound settings >>> page 155.

**Scan**: Automatic playback (SCAN function). When automatic playback is active, each of the tuneable stations in the selected frequency band are played for approximately 5 seconds each >>> page 175.

### Function button: function

**Seek mode**: To set the settings for the arrow buttons  and . The setting applies to all frequency bands (FM, AM and DAB).

**Preset list**: The arrow keys are used to switch between all of the saved stations in the selected frequency band.

**Station List**: The arrow keys are used to switch between all of the tuneable stations in the selected frequency band.

**Traffic programme (TP)**: The TP function (tracking of traffic information stations) is active >>> page 175.

**Delete presets**: To erase all or some of the preset stations.

**Station logos**: To assign logos to stations stored on memory buttons >>> page 174.

**Radio text**: The radio text is active >>> page 171, Radio text.

**Advanced settings**: DAB services settings.

**Autostore station logos<sup>a)</sup>**: Station logos are assigned automatically when the radio stations are stored on the memory buttons >>> page 174.

**DAB traffic announcements**: DAB traffic announcements are played in the same way as TP traffic announcements in any equipment mode.

**Other DAB announcements**: DAB announcements (news, sports information, weather, warnings, etc.) are played while the DAB Radio mode is active.

**DAB - DAB station tracking**: Automatic station tracking within the DAB frequency range is active.

### Function button: function

**Automatic DAB - FM switching**: Switching to the FM frequency band is permitted for automatic station tracking.

**Switch to a similar station**: This allows service providers to indicate alternative stations with similar content.<sup>b)</sup>

<sup>a)</sup> This depends on the country and unit in question.

<sup>b)</sup> Only available for the model: Navi System Plus

## Media

### Introduction

Audio or image sources containing files in different media are known as “**media sources**”. These audio files can be played through the corresponding players or the infotainment system's audio inputs.

Only supported files are displayed and played. Other files are ignored.

### Copyright

Consider the legislation on the intellectual property of audio and video files. »

### Note

- MPEG-4 HE-AAC audio coding technology and patents are licensed by Fraunhofer IIS.
- This product is protected by certain Microsoft Corporation copyright and property

rights. The use or commercialization of technology of this type outside the configuration of this product, without a licence from Microsoft or an authorised Microsoft branch is prohibited.

- The infotainment system only plays compatible undamaged audio files; other files are ignored.
- Check the list of compatible devices on the SEAT website.

### Requirements for data media and files

The factory-fitted CD and DVD players are class 1 according to DIN IEC 76 (CO) 6 / VDE 0837.

Only standard 12 cm CD/DVDs and 32 mm x 24 mm x 2.1 mm or 1.4 mm memory cards can be inserted in the infotainment system.

Any playable file formats on the list will hereinafter be known as “audio files”. A CD containing these types of audio files is called an “audio data CD”.





## Valid for the model: Navi System Plus

Data media	Playback requirements	
	Audio files	Video files
<p><b>Optical discs:</b></p> <ul style="list-style-type: none"> <li>– Audio CD (up to 80 min).</li> <li>– Standard video DVD and compatible audio DVD.</li> <li>– CD-ROM, CD-R, CD-RW with audio data up to a max. of 700 MB (megabyte) with the ISO 9660 Level 1 and 2, Joliet or UDF 1.02, 1.5, 2.01 file system.</li> <li>– DVD +/- R / RW up to a maximum of 4.7 GB and double layer DVD up to max. 8.5 GB in the Joliet file system (single session only); UDF.</li> </ul> <p><b>Memory cards:</b></p> <ul style="list-style-type: none"> <li>– SD and MMC in the file system must be FAT12, FAT16, FAT32 or VFAT (max 2 GB).</li> <li>– SDHC (max 32 GB) and SDXC (max 2 TB) with the exFAT and NTFS file systems.</li> </ul> <p><b>USB data media:</b></p> <ul style="list-style-type: none"> <li>– Devices with USB 2.0 and 3.0 specifications.</li> <li>– FAT16, FAT32, exFAT and NTFS file system.</li> <li>– Different generations of iPods<sup>™</sup>, iPads<sup>™</sup> and iPhones<sup>™</sup>.</li> <li>– MTP players with the trademarks “PlaysForSure” or “ReadyForVista”..</li> </ul> <p><b>Jukebox</b> (internal SSD memory).</p>	<ul style="list-style-type: none"> <li>– Digital Audio Specification.</li> <li>– MP2 (.mp2) and MP3 (.mp3) files with transfer rates from 32 to 320 kbit/s or variable transfer rate.</li> <li>– WAV files (.wav).</li> <li>– WMA files (.wma) up to 10 mono / stereo without copy protection and transfer rates of up to 384kbit/s.</li> <li>– AAC files (.m4a, .m4b and .aac) without copy protection.</li> <li>– OGG-Vorbis 1 (.ogg) files with transfer rates of up to 256kbit/s.</li> <li>– FLAC files (.flac).</li> <li>– Matroska container files (.mka).</li> </ul>	<ul style="list-style-type: none"> <li>v Maximum resolution 720 x 576 pixel and 25-30fps (frames per second).</li> <li>– MPEG-1 and MPEG-2 formats (.mpg, .mpeg, .m2ts, .avi and .mkv) with a maximum resolution of 352x288 pixels.</li> <li>– ISO MPEG-4 format (.mp4, .m4v, .avi, .mov, .3gp and .mkv).</li> <li>– MPEG-4 ASP DivX format 4, 5 and 6 (.avi, .divx and .mkv).</li> <li>– Xvid MPEG-4 format (.avi and .mkv).</li> <li>– MPEG-4 H.264 format: (.mp4, .m4v, .mov, .3gp, .avi, .m2ts, .mkv, .flv, .f4v and .webm).</li> <li>– Windows Media Video 9 format (.wmv, .asf, .mp4, .m4v, .mov, .3gp and .avi).</li> <li>– MJPEG format (.avi, .mov, .mp4 and .m4v).</li> <li>– Theora format (.ogv).</li> </ul>
<b>AUX</b> Playback of audio files through the AUX-IN jack.	– The external audio source must meet a series of playback conditions »» page 188.	
⑧ Playing audio files via Bluetooth <sup>®</sup> .	– The external media player must be compatible with the A2DP Bluetooth <sup>®</sup> profile »» page 189.	
📶 Playing audio files over WLAN.	– The external audio source must meet a series of playback conditions »» page 191	

a) iPod<sup>™</sup>, iPad<sup>™</sup> and iPhone<sup>™</sup> are protected trademarks of Apple Inc.

b) Bluetooth<sup>®</sup> is a registered trademark of Bluetooth<sup>®</sup> SIG, Inc.

## Valid for the model: Media System Plus/Navi System

Data media	Requirements for playing audio files
<p> <b>Optical discs:</b></p> <ul style="list-style-type: none"> <li>– Audio CD (up to 80 min).</li> <li>– CD-ROM, CD-R, CD-RW with audio data up to a max. of 700 MB (megabyte) with the ISO 9660 Level 1 and 2, Joliet or UDF 1.02, 1.5, 2.01 file system.</li> </ul> <p> <b>Memory cards:</b></p> <ul style="list-style-type: none"> <li>– SD and MMC in the file system must be FAT12, FAT16, FAT32 or VFAT (max 2 GB).</li> <li>– SDHC (max 32 GB) and SDXC (max 2 TB) with the exFAT and NTFS file systems.</li> </ul> <p> <b>USB data media:</b></p> <ul style="list-style-type: none"> <li>– Devices with USB 2.0 and 3.0 specifications.</li> <li>– FAT16, FAT32, exFAT and NTFS file system.</li> <li>– Different generations of iPods<sup>TMa)</sup>, iPads<sup>TMa)</sup> and iPhones<sup>TMa)</sup>.</li> <li>– MTP players with the trademarks “PlaysForSure” or “ReadyForVista”..</li> </ul>	<ul style="list-style-type: none"> <li>– Digital Audio Specification.</li> <li>– MP2 (.mp2) and MP3 (.mp3) files with transfer rates from 32 to 320 kbit/s or variable transfer rate.</li> <li>– WAV files (.wav).</li> <li>– WMA files (.wma) up to 10 mono / stereo without copy protection and transfer rates of up to 384kbit/s.</li> <li>– AAC files (.m4a, .m4b and .aac) without copy protection.</li> <li>– OGG-Vorbis 1 (.ogg) files with transfer rates of up to 256kbit/s.</li> <li>– FLAC files (.flac).</li> </ul> <ul style="list-style-type: none"> <li>– Playlists in the M3U, PLS, ASX and WPL formats.</li> <li>– Playlists must not exceed 20 kB or more than 1000 entries.</li> <li>– File names and routes that do not exceed 256 characters.</li> <li>– On memory cards, a maximum of 4000 files and a maximum of 1000 files per directory.</li> </ul>
<p><b>AUX</b> Playback of audio files through the AUX-IN jack.</p>	<ul style="list-style-type: none"> <li>– The external audio source must meet a series of playback conditions &gt;&gt;&gt; page 188.</li> </ul>
<p> Playing audio files via Bluetooth<sup>®b)</sup>.</p>	<ul style="list-style-type: none"> <li>– The external media player must be compatible with the A2DP Bluetooth<sup>®</sup> profile &gt;&gt;&gt; page 189.</li> </ul>
<p> Play audio files through WLAN.</p>	<ul style="list-style-type: none"> <li>– The external audio source must meet a series of playback conditions &gt;&gt;&gt; page 191</li> </ul>

a) iPod<sup>TM</sup>, iPad<sup>TM</sup> and iPhone<sup>TM</sup> are protected trademarks of Apple Inc.

b) Bluetooth<sup>®</sup> is a registered trademark of Bluetooth<sup>®</sup> SIG, Inc.

Read and bear in mind the instruction manual for the external data storage device.

### Limitations and indications

Dirt, high temperatures and mechanical damage can cause data media to fail. Con-

sider the indications provided by the manufacturer of the data media.

Quality differences between data media produced by different manufacturers can cause playback interference.

Consider copyright legislation!

The configuration of data media or of the equipment or programs used for recording may cause some tracks or data media to be unreadable. On the Internet, for example, can be found information about the best way to record audio files or data media (compression rate, ID3 tag, etc.).

The reading speed can vary considerably depending on the size, the usage status (copying and deleting processes), the structure of the folders and the type of files of the data media used.

**Playlists** only establish a certain playback order. The files are **not** saved in them. Playlists **cannot** be played if the files on the data media are **not** saved to the path to which the playlist refers.

A cover can only be displayed when the name starts with “Cover”, “Folder” or “Album”.



### Note

- Do not use memory card adaptors, USB extension cords or USB hubs!
- CUPRA assumes no liability for any deterioration or loss of files on data storage devices.

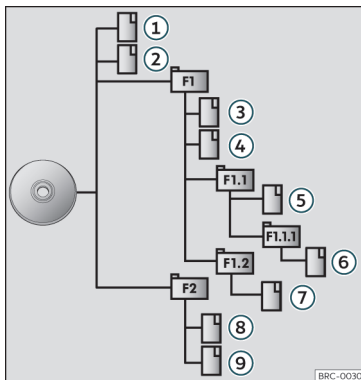

## Playback order of files and folders



**Fig. 148** Example of the structure of an audio data CD.

The audio files  stored on data media are often arranged by file folders  and playlists  to establish a certain playback order.

Depending on their name on the data media, tracks, folders and playlists are ordered numerically and alphabetically.

The illustration shows an example of a conventional audio data CD, containing tracks , folders  and subfolders  **>>> Fig. 148.**

In this case the tracks will be played as follows<sup>1)</sup>:

1. Tracks **①** and **②** in the root directory (Root) of the CD
2. Tracks **③** and **④** in the **first F1** folder of the CD root directory
3. Track **⑤** in the **first subfolder F1.1** of folder **F1**.
4. Track **⑥** in the **first subfolder F1.1.1** of subfolder **F1.1**
5. Track **⑦** in the **second subfolder F1.2** of folder **F1**
6. Track **⑧** and **⑨** in the **second folder F2**

### Note

- **The playback sequence can be modified by selecting the different playback modes >>> page 182.**
- **Playlists do not play automatically, they have to be selected directly from the track selection menu >>> page 185.**

<sup>1)</sup> The **Mix/repeat including subfolders** function must be active in the **Media settings** menu **>>> page 195.**

## MEDIA main menu

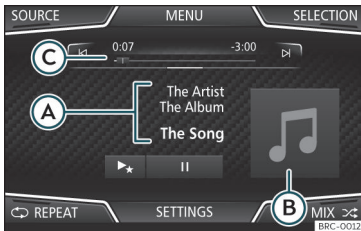

Fig. 149 MEDIA main menu.

Using the *Media* main menu, different media sources can be selected and played.

- Press the infotainment button to open the *Media* main menu >>> Fig. 149.

It will continue playing the last media source selected from the same point.

The media source being played is indicated on the dropdown list when pressing the **SOURCE** function button >>> Fig. 149.

If there is no available media source, the *Media* main menu is displayed.

## MEDIA main menu function buttons

### Function button: function

The media source that is being played. Press to select another media source.

**JUKEBOX**<sup>a)</sup>: Internal hard drive (SSD) >>> page 190.

**CD/DVD**<sup>a)</sup>: Internal >>> page 186 CD and DVD drive.

**SD CARD 1** **SD CARD 2**<sup>\*</sup>: SD memory card >>> page 187.

### SOURCE

**USB 1** **USB 2**<sup>\*</sup>: External data storage device connected to the USB port <-> >>> page 187.

**AUX**: External audio source connected to the AUX-IN multimedia socket >>> page 188.

**BT AUDIO**: Bluetooth<sup>®</sup> audio >>> page 189.

**WLAN**<sup>\*</sup>: External audio source connected by WLAN >>> page 191

### SELECTION

Depending on the level, track list, folders or source.



Changes track in Media mode or fast forward/rewind.



Playback stops. The function button changes to .

### Function button: function



Playback is resumed. The function button changes to .



Play similar tracks. Creates a virtual playlist that includes tracks with a similar rhythm to the one being played if available using Gracenote<sup>®</sup>.

### SETTINGS

Opens the menu **Media Settings**.



### REPEAT

Repeats all the tracks that are on the same memory level as the track being played at that moment. If in the **Media Settings** menu the **Mix/Repeat including subfolders** option is enabled, it also includes the subfolders.



### REPEAT

Repeat the current track.



### MIX

Random playback of tracks that are at the same memory level as the current track. If in the **Media Settings** menu the **Mix/Repeat including subfolders** option is enabled, it also includes the subfolders.

<sup>a)</sup> Only available for the Navi System Plus model.



## Indications and symbols of the MEDIA main menu

### Display: Meaning

A	<p>Information about the artist name, album name and song title.</p> <p>Audio CD: track information if available via Gracenote<sup>®a)</sup>. If no data is available, it only displays <b>Track</b> and the corresponding order number.</p>
B	<p>Album cover. The system prioritizes the display as follows:</p> <ul style="list-style-type: none"> <li>1st Cover embedded in the file(s).</li> <li>2nd Image in the file folder.</li> <li>3rd Image provided by the Gracenote<sup>®</sup> database<sup>a)</sup></li> <li>4th Icon of the connected device.</li> </ul> <p>If playing a video file, by pressing the icon (cover) it can be played on full screen.</p>
C	<p>The playing time so far and time remaining in minutes and seconds.</p>
RDS off <sup>b)</sup>	<p>The RDS radio data service is deactivated. The RDS can be activated in the <b>FM settings</b> menu.</p>
TP <sup>b)</sup>	<p>The TP function is active and can be tuned in.</p>
TR <sup>b)</sup>	<p>There is no traffic news station available.</p>

### Display: Meaning

 b) DAB not available.

a) Gracenote<sup>®</sup> is a database available on the Infotainment system hard drive that contains information on the tracks of different artists and albums. In order for the user to benefit from the functions offered by Gracenote<sup>®</sup>, the tracks must contain the artist and/or album data (only available for the model: Navi System Plus).

b) Depends on the market and unit in question.

### Note

- **When the media source is inserted, playing will not start automatically; it is necessary for the user to select the source. Nor will the media source change when it is ejected.**
- **In order to see the different covers inside of the same album/folder, make sure that the tracks contain different information about the Artist or Album in its metadata. If not, you will see the same cover for all of tracks contained in the same album/folder.**

## Switching the Media source

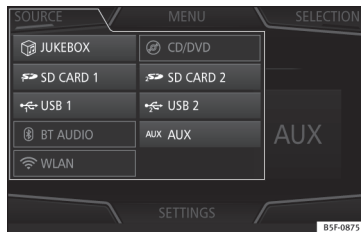

Fig. 150 MEDIA mode: switching media source.

- Lower the base volume on the Infotainment system.
- From the *Media* main menu, press the **SOURCE** function button >>> **Fig. 150** and select the desired media source.
- **OR:** from the *Media* main menu, press the **Infotainment** button repeatedly to cycle through the available media sources.

In the pop-up window, the Media sources not selected are shown as deactivated (in grey).

When a Media source that has already been played is selected again, playback is resumed from the point at which it was stopped.

### Note

The Media source can be changed in the **Track list** view: select **Media > View**.

## Changing track in the MEDIA main menu

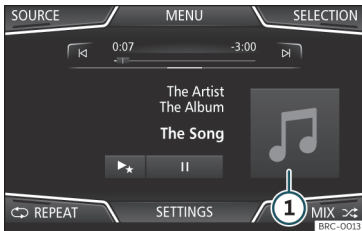

Fig. 151 MEDIA main menu.

The tracks of the Media source that is being listened to can be changed successively using the arrow buttons.

The arrow buttons **cannot** be used to exit a playlist or start the playback of a playlist. Both actions have to be performed manually from the track selection menu >>> page 185 .

## Control through the MEDIA main menu

Action	Function
Briefly press the function button <b>[K]</b> once.	At the start of the current track. If the track has been played for less than 3 seconds, it returns to the start of the previous track.

Action	Function
Press the function button <b>[K]</b> twice in a row.	If the track has been played for more than 3 seconds, it returns to the start of the previous track. If the first track is being played, pressing the button goes back to the last track on the data media that is being played.
Briefly press the function button <b>[B]</b> once.	To the next track. It changes the last track to the first track on the data media that is being played.
Press and hold function button <b>[K]</b> .	Rewind.
Press and hold function button <b>[B]</b> .	Fast forward.
Slide your finger horizontally over the screen.	Change to the previous/next track, with the same playback times as changing tracks with the keys <b>[K]</b> or <b>[B]</b> .

## Selecting an album by cover

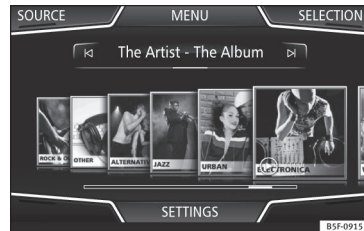

Fig. 152 Selection by cover.

Clicking on the current cover >>> Fig. 151 ① will display all of the album covers available in the active Media source >>> Fig. 152.

It is possible to browse through all the albums by sliding the covers right or left, by using the bottom horizontal scroll bar, or by using the settings button.

The cover selection view closes after approximately 5 seconds of inactivity and the Media main menu is displayed again.

## Selecting a track from a track list

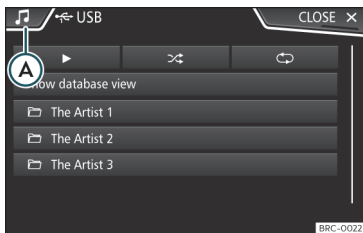

**Fig. 153** Media Mode: list of folders of a Media source.

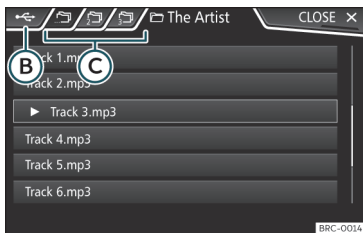

**Fig. 154** Media Mode: list of tracks of a Media source.

### Open a list of tracks

- Press the **SELECT** function button on the **MEDIA** main menu >>> **Fig. 151** to open the track list. The track that is playing is highlighted >>> **Fig. 154**.

- Search the track list and press the track you want.

If there is track information available, the track (on audio CDs) or the file name (MP3) is displayed instead of **Track + num.**

### Overview of the function buttons in the track list

#### Function button: function

- A** Open the **Sources** menu. Select another Media source by pressing.

#### Function button: function

Indicates the media source being explored. If pressed, it goes to the root of the device shown on the icon.

**(JUKEBOX)<sup>1)</sup>**: Internal hard disk of the infotainment system (SSD) >>> page 190.

**(CD/DVD)<sup>a)</sup>**: Internal >>> page 186 CD and DVD drive.

**(SD CARD 1)** **(SD CARD 2)<sup>\*</sup>**: SD memory card >>> page 187.

- B** **(USB 1)** **(USB 2)<sup>\*</sup>**: External data storage device connected to the USB port <->
- >>> page 187.

**(BT AUDIO)**: External Media Player connected via Bluetooth® >>> page 189.

**(AUX)**: Audio source connected to the AUX-IN socket. >>> page 188

**(WLAN)<sup>\*</sup>**: External audio source connected by WLAN >>> page 191

- C** Press the function button to open the top folder of the Media source.

- ▶** Start playback of the first track. >>>

## Function button: function

Repeat all tracks.



Repeats all the tracks that are on the same memory level as the track being played at that moment. If in the **Media Settings** menu the **Mix/Repeat including subfolders** option is enabled, it also includes the subfolders >>> page 195.

Random play.



Includes all the tracks that are on the same memory level as the track being played at that moment. If in the **Media Settings** menu the **Mix/Repeat including subfolders** option is enabled, it also includes the subfolders >>> page 195.

**CLOSE x** To close the tracks list.

a) Only available for the model: Navi System Plus.

### **i** Note

**Tracks, folders and playlists can also be selected by turning the setting button, and they can be played or opened by pressing it.**

## Data bank view

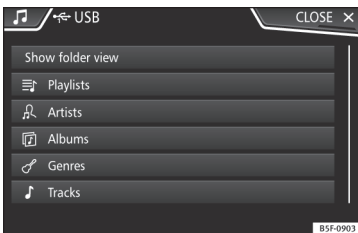

**Fig. 155** Media Mode: data bank view

On the track list, click the **Show database view** option. The content of the current Media source will be listed by **Playlists**, **Artists**, **Albums**, **Genres**, **Tracks** and **Videos** >>> **Fig. 153**.

When selecting one of the folders **Artists**, **Albums** or **Titles**, a search button is displayed in the upper right corner (magnifying glass) that allows searching within the selected category >>> page 152, Input window with on-screen keypad.

To return to the folder view, press the **Show folder view** option on the **SELECTION** menu.

## Insert or remove a CD or DVD

✓ The DVD drive is only available for model: Navi System Plus

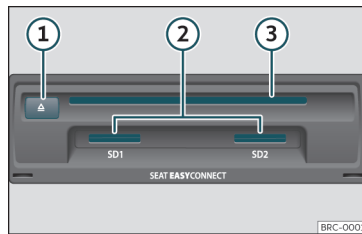

**Fig. 156** Slots for data storage devices in the glove compartment.

The driver should refrain from operating the unit while the vehicle is in motion. Insert or change the data storage device before moving off!

The CD and DVD drive can play audio CDs and DVDs and audio data CDs and DVDs.

### Insert a CD or DVD

- Insert a CD or DVD into the slot >>> **Fig. 156** ③ with the printed side facing upwards, until the equipment inserts it automatically.

### Eject a CD or DVD

- Press button **△** ①.

- The CD or DVD in the drive will be ejected and must be removed within approximately 10 seconds.

If the CD is not removed within 10 seconds, it is automatically retracted for security reasons without activating the CD mode.

### Unreadable or defective CD or DVD

If the data on an inserted CD or DVD cannot be read or a defective CD or DVD is inserted, the corresponding warning appears on screen.

Depending on the equipment, unreadable CDs or DVDs are automatically ejected 3 times and reinserted to start another three read attempts before this indication is displayed.

#### Note

- Uneven road surfaces and strong vibrations can cause playback to jump.
- When the temperature inside the equipment is too high, loading and playback of CDs and DVDs is disabled.
- If after inserting a number of different or DVDs and receiving the CD or DVD drive error, every time, contact a specialised workshop.

### Inserting or ejecting a memory card

Depending on the features and the country, the vehicle may have one or two slots for SD cards.

#### Inserting a memory card

Insert the compatible memory card, with the cut corner first and the contacts facing down, into slot »» Fig. 156 (2), until it clicks into place.

#### Removing a memory card

The inserted memory cards **must** be prepared for removal.

- From the main *Media* menu, press the **SETTINGS** button to open the **Media Settings** menu or press the infotainment button  and then press **Settings** to open menu **System settings**.
- Press the **(Remove safely)** function button. A dropdown menu appears with the following options: SD1 Card, SD2 Card\*, USB1 and USB2\*. Pressing the corresponding function button disables it.
- Press the inserted memory card. The memory card “jumps” to the eject position.
- Remove the memory card.

### External data storage device connected to the USB port

Depending on the features and the country, the vehicle may have one or two USB connections »» page 224.

Where this manual refers to external data storage devices, this means USB mass storage devices containing supported audio files, such as MP3 players, iPods™ and USB sticks.

Only supported audio files are displayed and played. Other files are ignored.

Further operation of the external data medium (changing track, selecting tracks and playback modes) is described in the appropriate chapters of this manual »» page 177.

#### Instructions and restrictions

Compatibility with Apple™ devices and other media players depends on the unit.

The USB port  supplies the usual USB voltage of 5 volts for a USB connection.

External hard disks larger than 32 GB must be reformatted for the FAT32 file system in some circumstances. You will find the necessary software and information on the Internet. »

Take into account all other instructions and limitations regarding requirements for media sources.

## iPod™, iPad™ and iPhone™

Depending on the country and equipment, iPods™, iPads™ or iPhones™ can be connected via the device's own USB cable to the vehicle's USB port and used as audio sources.

After connecting an iPod™, iPad™ or iPhone™, the list views specific to the iPod™ are displayed at the top selection level (Playlists, Artists, Albums, Tracks, Podcasts etc.).

## Possible error messages after connecting external data media

Error message	Cause and actions to take
Source is not supported.	It is not possible to play the external data media or establish communication with the adapter cable that is used.  Check that the external data media is connected and operates correctly. If possible, update the external data media software.

Error message	Cause and actions to take
Device not responding.	Communication interrupted.  Check that the external data media is connected and operates correctly.
Due to the large number of different data storage devices and various iPod™, iPad™ and iPhone™ generations available, it is not possible to guarantee fault-free operation of all functions described here.	

## Disconnecting

Data media be prepared for disconnection.

- From the main *Media* menu, press the **SETTINGS** button to open the **Media Settings** menu or press the infotainment button and then press **Settings** to open menu **System settings**.
- Press the **(Remove safely)** function button. A dropdown menu appears with the following options: SD1 Card, SD2 Card\*, USB1 and USB2\*. Pressing the corresponding function button disables it.
- Now the data storage device can be disconnected.

### **i** Note

- Do not connect an external media player at the same time to play music via Bluetooth® and via the USB port with the In-**

fotainment system, as this could cause playback limitations.

- If the external player is an Apple™ device, it cannot be simultaneously connected by USB and by Bluetooth®.**
- If a connected source is not recognized, disconnect and reconnect it. If the data cannot be played, the corresponding indication will be displayed.**

## External audio source connected to the AUX-IN multimedia socket

Depending on the equipment and country there may be an AUX-IN multimedia socket >>> page 224.

The connected external audio source **cannot** be operated with the infotainment system's controls.

## Connecting an external audio source to the AUX-IN multimedia socket

- Connect the external audio source to the AUX-IN multimedia socket.
- Start playback on the external audio source.
- In the **MEDIA** main menu, press the **(SOURCE)** function button and select **(AUX)**.

The **playback volume** of the connected external audio source should be adjusted to

the volume of the other audio sources  
»» page 155.

### Information on operating an external audio source connected to the AUX-IN multimedia socket

Operation	Effect
Selection of another audio source from the Infotainment system.	The external audio source continues to run in the background.
Stopping playback on the external audio source.	The infotainment system remains in the AUX menu.
Remove the connector from the AUX-IN multimedia jack.	The infotainment system remains in the AUX menu.

#### Note

- Please read and observe the manufacturer's instruction manual for the external audio source.
- Interference noise may be heard if the external audio source is powered from the 12-volt power socket of the vehicle.

### Connect an external audio source via Bluetooth®

In the Bluetooth® Audio mode, audio files that are playing on a device connected by

Bluetooth can be listened to on the infotainment system.

#### Conditions

- The Bluetooth® audio source must support the A2DP Bluetooth® profile.
- In the **Bluetooth® Settings** menu the **Bluetooth Audio (A2DP/AVRCP)** function must be on. Select **Telephone > Settings > Bluetooth**

#### Starting Bluetooth® audio transfer

- Activate Bluetooth® visibility on the external Bluetooth® audio source.
- In the MEDIA main menu, press the **SOURCE** function button and select **BT audio**.
- Press **Search for new device** in order to connect an external Bluetooth® audio source for the first time »» page 214.
- **OR:** Select a Bluetooth® external audio source from the list.
- Please refer to the instructions on the screen of the Infotainment system and on the Bluetooth® audio source regarding the rest of the procedure.

You may need to manually start playback on the Bluetooth® source.

When the Bluetooth® device is disconnected, the infotainment system remains in Bluetooth® audio mode.

#### Controlling playback

The extent to which the Bluetooth® audio system can be operated through the infotainment system depends on the connected Bluetooth® device.

#### Note

- Due to the large number of possible Bluetooth® audio sources, it is not possible to guarantee fault-free operation of all described functions.
- Always switch off the warning and service tones on a connected Bluetooth® audio source, e.g. key tones on a mobile telephone, to prevent possible interference noise and malfunctions.
- To play music, do not link the external media player simultaneously to Bluetooth® and the USB interface of the infotainment system, as this can cause limitations during playback.
- The system response time may vary, depending on the connected external playback device.
- If the external player is an Apple™ device, it cannot be simultaneously connected by USB and by Bluetooth®.

## Jukebox (SSD)

- ✓ Only available for the model: Navi System Plus

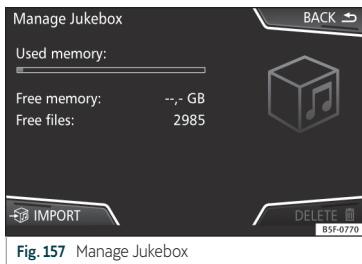

Fig. 157 Manage Jukebox

The “jukebox” is located on the hard drive of the Infotainment system (SSD<sup>1)</sup>.

Compressed audio files (MP3 and WMA) and some video files (Podcasts, AVIs, etc.) can be imported from different data storage devices to the **jukebox** and this used to play them.

The files will only be copied when the engine is running. Copying copy-protected CDs and DVDs is prohibited

### Importing files

- In Media mode, press the **SETTINGS** function button and then select **Manage Jukebox**.
- Press the **IMPORT** function button.
- Select the desired source from the **Select source** menu.

The data storage device is prepared. This operation may take a few seconds.

- Activate the checkboxes to the right of the files or folders to be imported.
- If **Select all** is activated, all files and folders on the data storage device will be imported.
- Press the **IMPORT** function button.

Depending on the selection, all files and folders will be imported with the indicated name to the **Jukebox**.

If no track information is available, the audio files will be placed in the following folders:

### Audio data CD

- **Album**
  - **Unknown albums**
    - **Título.mp3<sup>2)</sup>**
- **Artists**

- **Unknown artists**
  - **Unknown albums**
    - **Título.mp3<sup>2)</sup>**

### Functions and progress display during the copying operation

While copying, an animation is displayed along with the progress percentage on the import screen.

**Audio data CD:** It is not possible to copy and play files at the same time.

- Press the **CANCEL** function button to end the import of the whole track that is currently being imported.
- To obtain information on the status of the import, press the **Information** function button.
- Press the **BACK** function button to close the import screen with the progress information.
- When the file import ends, a message will appear.

### Deleting files

- In Media mode, press the **SETTINGS** function button and then select **Manage Jukebox**.

<sup>1)</sup> Solid-State-Drive (SSD).

<sup>2)</sup> The name and extension of the file are examples.



- Press the **DELETE** function button.
- Activate the checkboxes to the right of the files or folders to be deleted.
- If **Select all** is activated, all the files and folders on the data storage device will be deleted.
- Press the **DELETE** function button. The files and folders will be deleted according to the selection made.
- When the files have been deleted, a message will appear.
- Press the **BACK** function button to close the menu.

### Opening stored audio and video files

- Change to **Jukebox** (SSD) content.

When storing the tracks, they are stored under different categories and lists according to the information available.

The tracks saved can be checked and opened from these lists according to different categories.

### Jukebox

- Playlist
- Artist
- Album
- Music genre
- Title

- Video
- Non-playable files (an unsupported file has been imported).

#### Note

- If the Infotainment system cancels a copying operation, check the storage space on the internal hard drive and check the data storage device.
- Due to copyright laws, before any change in ownership of the Infotainment system, all files stored on the jukebox must be deleted.
- There are several possible reasons why files may be shown as inactive (grey): files that cannot be imported (e.g. images), files that are already stored in the Jukebox or files that take up more space than available in the internal memory.

### Connect an external audio source via WLAN\*

WLAN allows wireless connection between an external audio source and the Infotainment system.

To use this connection, the device being connected must have an app compatible with the UPnP (Universal Plug and Play) communication protocol.

### Conditions

- Having a compatible (UPnP) app installed on the device.
- Having the **Enable WLAN connection** option active, which can be found in the wireless connection configuration.
- Pairing the mobile device to the Infotainment system using a password generated by the system. Pairing must be done from the device to be connected.

### Starting the WLAN audio transfer

- Start the UPnP app or the app for the playback of the WLAN audio source.
- In the MEDIA main menu, press the **SOURCE** function button and select **WLAN**.
- Please refer to the instructions on the screen of the Infotainment system and on the WLAN audio source regarding the rest of the procedure.

### Controlling playback

The extent to which the WLAN audio can be controlled via the Infotainment system depends on the connected WLAN device and the app that is used. »

## Note

- The Infotainment system does not provide an internet connection, it only establishes a wireless connection between the mobile device and said system.
- Via the WLAN, only the connection between the device and the Infotainment system can be guaranteed, its operation depends on the application itself.

## WLAN settings

To access the WLAN settings the ignition must be switched on.

- Select the Media main menu by pressing the infotainment button .
- Press the **SETTINGS** function button to open the **Media settings** menu.
- Press the **WLAN** function button, then the **Share connection over WLAN** button will appear along with information about the use of WLAN.
- Press the function button **Share connection over WLAN**, then you can **Enable WLAN connection** and access the WLAN network **Configuration**.
- Press the **Configuration** function button to configure the WLAN network.

## Function button: function

**Enable WLAN connection**: To turn on/off the WLAN network.

**Security level**: WPA2 encryption automatically generates an 8 character network key.

**Network key**: Network key automatically generated. Press the function button to manually change the network key. The network key must have a minimum of 8 characters and a maximum of 63.

**SSID**: Name of the WLAN network of the infotainment system.

**Do not send network name (SSID)**: Activate the checkbox to deactivate the visibility of the WLAN network.

To save the changes made to the configuration of the mobile access point, press the **SAVE** button.

## Video DVD mode

- ✓ Only available for the model: Navi System Plus



Fig. 158 DVD main menu.

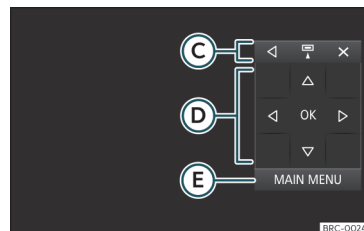

Fig. 159 DVD mode control menu.

## Regional code of video DVD

Quite often, the playback of DVD video is limited to certain regions (for example, to the US and Canada) by so-called region “codes”. These DVDs can only be played on units that are coded for the same region.

The unit's DVD drive is configured to read the regional code for the region in which the vehicle was originally sold.

### Starting the DVD mode

- Insert a compatible DVD in the DVD drive.

The reading of DVD data may take a few seconds.

The DVD's "intro" (short initial sequence) is played. Next, the different DVD menus are displayed.

### Controlling a DVD menu

- Briefly touch the screen to activate the function buttons in the *DVD mode* main menu »» Fig. 158.

Function button: function	
SOURCE	Display and selection of the source.
DVD MENU	To display the control menu and return to the main DVD screen»» Fig. 159.
(A)	Chapter display.
(B)	Displays play time duration and remaining play time.

Function button: function	
(C)	<ul style="list-style-type: none"> <li>(◀): Move the control menu window.</li> <li>(▢): Minimise the control menu window.</li> <li>(▣): Maximise the control menu window.</li> <li>(X): Close the control menu.</li> </ul>
(D)	Use the arrow buttons to browse the DVD menu. Confirm the selection by pressing (OK).
(E)	Press to open the DVD main menu.
⏪ / ⏩	To move to the next or previous chapter.
⏸	Playback stops. The (⏸) function button changes to (▶).
▶	Playback is resumed. The (▶) function button changes to (⏸).
SETTINGS	This menu contains the Video (DVD) settings.
<b>i Note</b>	
<ul style="list-style-type: none"> <li>• The visual appearance of the DVD film menus and the menu options which it offers are the responsibility of the DVD manufacturer.</li> <li>• The difference in behaviour of some films when using the same mode is the responsibility of the DVD manufacturer.</li> </ul>	

- You may not be able to play video DVDs which you have burned yourself.
- The Infotainment system screen only displays the image when the vehicle is stopped. Whilst in motion, the screen disconnects (the image), but the audio remains active.

### Video settings (DVD)

- ✓ Only available for the model: Navi System Plus

While in the *DVD mode* press the (SETTINGS) function button and then select the Video settings (DVD) option.

Function button: function	
(Format)	To select the screen format. If <b>Automatic</b> is selected, the optimal format for the screen is set automatically.
(Audio channel)	To select the language of the voice instructions.
(Subtitles)	To select the subtitle language.
(Enter/change PIN for parental settings)	Parental settings password.
(Child protection)	To select the level of protection you want to associate with DVD playback.

The options within the Video Settings (DVD) menu may vary depending on the DVD or the chapter that is playing. »

The available audio channel languages and subtitles depend on the DVD that is inserted.

All or part of the content of a video DVD can be protected by a password (PIN) if the DVD allows parental settings. In addition, you can choose the restriction level based on age, with 1 being the least restrictive (all audiences) and 8 the most restrictive (adults).

## Images

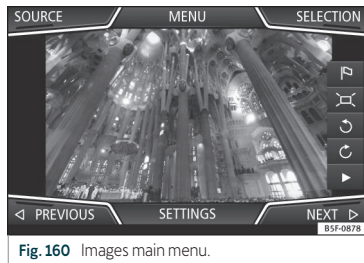









Fig. 160 Images main menu.

Using the *Images* menu, image files can be viewed (e.g. photos) individually or as a slideshow.

The image files must be stored on a compatible data storage device.

- Press the Infotainment  button and then select the **Images** context.

- Press the **SOURCE** function button to select the source where the pictures in question are located.

Function button: function	
<b>SOURCE</b>	Selection of the source.
<b>SELECTION</b>	Opens a list of image files.
	The image viewed was obtained via GPS localisation and upon pressing this function button, the navigator menu opens to start a route to this destination.
	Rotate the image view 90° left or right, or by swiping your fingers across the screen in a circular direction.
	Reset the view of the image.
	To stop the playback of a slideshow. The <b>II</b> function button changes to  .
	To continue the playback of a slideshow. The  function button changes to <b>II</b> .
	Change image <b>PREVIOUS</b> or <b>NEXT</b> , or by sliding your finger horizontally across the screen.
<b>SETTINGS</b>	Open the Image settings menu.

### Enlarging or reducing the view

- Slide 2 fingers across the screen, moving them further apart or closer together.

- **OR:** turn the settings button.

### Requirements for viewing images

Image files	Maximum resolution
BMP	4MP
JPEG	4MP (Progressive Mode)
JPG	64MP
GIF	4MP
PNG	4MP

## Image settings

### Open the **Image settings** menu

- Press the **SETTINGS** function button in the main *Images* menu.

### Function button: function

**Image view:** To adjust the image view format.

**Automatic:** Images scale to the size of the screen (the image may not be displayed completely).

**Complete:** The images are displayed fully on the screen.

**Display time:** To adjust the display time of images during a slideshow.

**Repeat slideshow:** The active slideshow is repeated infinitely.

## Media settings

- Select the **MEDIA** main menu by pressing the infotainment button .
- Press the **SETTINGS** function button to open the **Media settings** menu.

### Function button: function

**Sound**: Sound settings »» page 155.

**Manage Jukebox**<sup>a)</sup>: To import files to the jukebox or to delete existing files »» page 190.

**Mix/repeat including subfolders**: Subfolders are included in the selected playback mode »» page 177.

**Bluetooth**<sup>®</sup>: Bluetooth<sup>®</sup> settings »» page 222

**WLAN**<sup>a)</sup>: WLAN settings »» page 192.

**Video settings**: Settings for playing DVD videos or files.

**Remove safely**: To prepare external data media for extraction or disconnection. See also »» page 187, Inserting or ejecting a memory card and »» page 187, External data storage device connected to the USB port .

**Traffic programme (TP)**: The TP function (tracking of traffic information stations) is active »» page 175.

<sup>a)</sup> Only available for the model: Navi System Plus.

## Navigation

### Introduction

#### General information

A GPS (Global Positioning System) satellite system locates the current position of the vehicle. The vehicle's sensors measure the distance travelled. The measurements are compared with the stored detailed map resources, according to road indications stored in them. Traffic reports, if any, will also be taken into account in the route calculation (dynamic route guidance »» page 203). Using all the data available, the Infotainment system calculates the optimum route to the destination.

The destination is defined by entering an address or a point of interest, e.g. a petrol station or hotel.

Navigation announcements and graphic representations will guide you to your destination.

Depending on the country, some functions of the infotainment system will not be available on the screen when travelling higher than a certain speed. It is not a malfunction, but is due to compliance with legislation.

### CAUTION

The navigation announcements may be inaccurate (e.g. due to out-of-date data).

### Instructions for navigation

When the Infotainment system is unable to receive any data from GPS satellites (tunnels, garages), navigation can still continue using the vehicle sensors.

#### Possible limitations in navigation

In areas that are not or are only partially digitised (e.g. insufficient definition of one-way streets and road categories), the Infotainment system will still attempt to provide route guidance.

In the case of missing or incomplete navigation data, it may not be possible to determine the exact position of the vehicle. This may mean that navigation is not as precise as usual.

#### Navigation area and update of navigation data

Road layouts change continuously. Therefore, if the navigation data are not updated, then errors or inaccuracies may occur.

CUPRA recommends updating navigation data on a regular basis.

## Updating and using navigation data from an SD card

- ✓ Only available for the model: Navi System

The SD card is factory fitted in slot 2 for SD cards.

Navigation data that is currently valid for this unit in order to allow all functions to be used in full.

### Updating navigation data

The current navigation data can be downloaded in the internet at [www.seat.com](http://www.seat.com) and stored in a SD card compatible with the unit.

Suitable SD Cards can be acquired at SEAT dealerships.

The procedure is described on the internet at [www.seat.com](http://www.seat.com).

### Using navigation data

- Insert the memory card >>> page 187.
- Wait for the testing icon to disappear.

If the inserted memory card contains navigation data, the following message appears: **“The source contains the navigation database”**. Navigation can be started.

#### Note

- The inserted memory card must be prepared before it is ejected >>> page 187.

- Navigation is not possible without the SD card.
- Do not remove the memory card while the navigation data is in use. This could damage the memory card!
- The navigation memory card cannot be used as a memory for other files.
- CUPRA recommends using only the original SEAT cards. The use of other memory cards could limit its operation.

## Updating and installing navigation data

- ✓ Only available for the model: Navi System Plus

The Infotainment system is equipped with an internal navigation data memory. The required navigation data are already installed on the system.

The Infotainment system always requires the navigation data that is currently valid for this unit in order to allow all functions to be used in full. Using an old version may lead to errors during navigation.

### Updating navigation data

To update navigation data visit our website: [www.seat.com](http://www.seat.com).

The navigation data must be installed after downloading. Navigation is not possible from the memory card.

### Installing navigation data

The installation process takes about 2 hours.

If the Infotainment system is switched off, the installation process is paused and will automatically resume when switched back on.

- Switch the ignition on.
- Insert the memory card containing the navigation data >>> page 187.
- Press the infotainment key  > **Settings** > **System information**.
- Press **UPDATE** to import the stored navigation data.
- Follow the instructions displayed on the screen.

Once installed, the memory card can be removed. The memory card must be prepared for removal >>> page 187.

#### CAUTION

Do not remove the memory card while the navigation data is being installed. The memory card may be irreparably damaged!

#### Note

- The navigation memory card may not be used as memory storage for other files. The

Infotainment system will not recognise the files saved on it.

- CUPRA recommends a CLASS 10<sup>1)</sup> memory card for the use of navigation data. The use of other memory cards could limit its operation.

### Navigation main menu

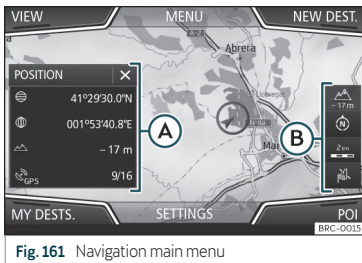

Fig. 161 Navigation main menu

Navigation functions can only be used if the navigation data for the area where the vehicle is driving is available in the infotainment system.

The *Navigation* main menu allows you to select a new destination, call up a previously used or stored destination and search for points of interest.

### Opening the main Navigation menu

- Press the Infotainment system button to open the last menu that was open in navigation.
- If the *Navigation* main menu is **not** displayed, press the infotainment button again until the main *navigation* menu is displayed.
- **OR:** Press the function button to return menu by menu to the *Navigation* menu.

### Navigation main menu function buttons and indicators

#### Function button: function

- (A) The split screen is displayed >>> page 202.
- (B) Messages and function buttons on the map display >>> page 202.

(New destination): To enter a new destination >>> page 197.

(ROUTE): During route guidance >>> page 199.

(MY DESTS.): To activate or manage stored destinations >>> page 199.

(POI): Search for points of interest (car parks, fuel stations and restaurants) within a particular search area >>> page 201.

(VIEW) To modify or activate or deactivate the split screen and show POI >>> Fig. 161 (A) >>> page 201.

#### Function button: function

(SETTINGS) Open the *Navigation Settings* menu.

### New destination (entering the destination)



Fig. 162 Search screen.

- In the *Navigation* main menu, press the (New destination) function button.
- Press the (Options) function button and select the required type of destination (**Search, Address, POI or On map**).
- Using voice control\*, if you say Town, street and number, without pauses, and then the instruction "Start Route Guidance" a route to the given destination will start. >>>

<sup>1)</sup> The speed class of an SD card.

## Search

Search for addresses and Points of Interest using the keypad to enter them >>> **Fig. 162**.

For cities, post codes and points of interest, the full details must be entered. You can also search for points of interest by names or categories. When necessary, enter the name of the city to refine the search.

### >>> Fig. 162



Press to open the cursor buttons (<, >), which allow you to move within the text.

## Steering

When narrowing down the destination address, **please note** that every entry restricts the available range of subsequent selections.

To enter an address press the function buttons in the following order:

- **Country, City** (or postcode), **Centre** (starts the route to the centre of the indicated city), **Street, Number, Junction, Last destinations, Start** (starts route guidance to the selected destination).

## On the map

- Select the destination on the map or enter it using GPS coordinates and confirm with



## Function button: function

**(Store)**: Store the point of interest in the destination memory >>> page 199.

**(Edit)**: Edit the destination or enter another one.

**(Route options)**: Setting route options, see **Navigation Settings > Route options**.

**(Start)**: Starts guided navigation to the selected point of interest.

## After starting route guidance

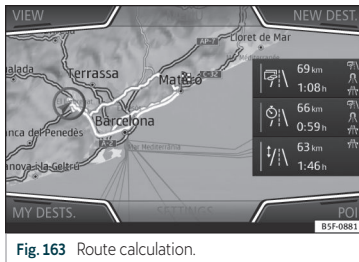

**Fig. 163** Route calculation.

When starting route guidance, the route is calculated based on the data that have been selected in the **Route options** menu.

Three **alternative routes** are proposed >>> **Fig. 163**. These 3 routes correspond to the selectable route options: *Economical, Fast and Short*.

**Blue route** Economic route.

**Red route** Fastest route.

**Orange route** Shortest route to the destination, even if it results in longer travelling time.

- Select the desired route by pressing it.

The route criteria settings in the **Route options** menu are modified accordingly.

If a route is not selected, the route guidance starts automatically after approx. one minute according to the setting selected in **Route options**.

Once the route has been calculated, the system gives the first navigation announcement. Up to 3 navigation announcements are given before a turn.

- Press the adjustment knob to listen to the last audible navigation instruction.

The indicated distances depend to a great extent on the type of road and the traffic speed. On motorways, for example, navigation announcements are received much earlier than in urban traffic.

The corresponding navigation announcements are also given on roads with several lanes that split, and on roundabouts, for example: "Leave the roundabout at the second exit."



A navigation announcement informs you when you have reached your “destination”.

A navigation announcement informing you that you have reached the “destination area” is given if the exact destination cannot be reached.

During **dynamic route guidance**, you receive information about reported traffic congestion on the route. An additional navigation announcement is given if the route is recalculated.

During a navigation announcement, you can change its volume using the button .

For other announcement settings, select **Navigation > Settings > Navigation announcements**.

### Note

- If you miss a turning during route guidance and are currently unable to turn back, keep on driving until the navigation system offers a new route.
- The quality of the announcements and recommendations depends on the navigation data available and any reported traffic problems.

## Route

In the *Navigation* main menu, press the **Route** function button.

The **Route** function button is only displayed with route guidance activated.

### Function button: function

**STOP GUIDANCE**: Aborts current route guidance.

**ENTER DESTINATION**: To enter a new destination or a new stopover >>> page 197.

**CONGESTION AHEAD**: To exclude a section of the route. To cancel the exclusion, press the **Route** function button and then **CANCEL CONGESTION**.

**CHANGE ROUTE**<sup>a)</sup>: The map of the calculated route appears and by holding a finger on the route and dragging the finger across said map, the route is changed to the road(s) that you want and the new route is then recalculated.

**ROUTE DETAILS**: View route information.

<sup>a)</sup> Only available for the model: Navi System Plus

## My destinations (destination memory)

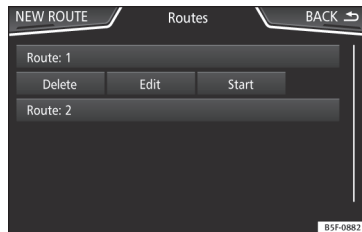

Fig. 164 List of saved routes.

The stored destinations can be selected from the **My destinations** menu.

- Press the **My destinations** function button in the main *Navigation* menu.
- Select the desired function button. **STORE POSITION**, **Routes**, **Destinations**, **Last destinations** or **Home address**.

### Store position

- By pressing the **STORE POSITION** function button, the current position is stored as a **Flagged destination** in the Destination memory.

To save the stored position permanently as a **flagged destination**, change the name of the position in the destination memory. Otherwise, the saved position is overwritten when another flagged destination is saved. »

- Mark the **Flagged destination** in the destination memory.
- Press the **Store** function button.

The name can be changed in the following input window. Press the **in** function button to store the destination.

## Routes

In the **Route** mode, you can define various destinations (final destination and stopovers).

The **starting point** of a route is always the vehicle's current position. The **destination** is the end point of a route. **Stopover destinations** are driven to before the destination.

- In the *Navigation* main menu, press the **My Destinations** function button.
- Press the **Routes** function button.

If you have not stored any routes or want to create a new route, press the **New route** function button and then follow the instructions as for a new destination, before pressing **Store**.

Pressing on a stored route brings up the following function buttons:

### Function button: function

**Delete**: To delete a stored route.







**Edit**: To edit and store a route.

### Function button: function



**Start**: To start route guidance.

## Function buttons and indications in the New route or Edit menu

### Function button or message: function or meaning

	Stopover.
	Destination.
	Estimated time of arrival.
	Calculated distance to destination.
	Estimated travelling time.
	Distance to the next stopover.

### Press on the destination to display the function buttons.

	Delete destination.
	Starting route guidance direct to the selected destination. The stages are omitted.
	Opening the detailed view of the destination in question.

### Available function buttons.

<b>New destination</b>	Add a new destination.
------------------------	------------------------

<b>Destinations</b>	Adding a new destination from <b>My destinations</b> .
<b>Storing</b>	To store the created route in the route memory.
<b>Start</b>	Start route guidance.
<b>Calculate</b>	To update the calculated distance and estimated arrival time. <sup>a)</sup>
<b>Stop</b>	To stop active route guidance. <sup>b)</sup>
	Moving a stopover or a destination to another position on the list. Press and drag to move the destination.

<sup>a)</sup> Only displayed with route guidance activated and when a destination has been added to the tour.

<sup>b)</sup> Only displayed with route guidance activated.

## Last destinations

List of last destinations.

## My destinations

- Press the **Options** function button and select the desired function button.

### Function button: function

**Destination memory**: View of destinations stored manually and from imported vCards >>> page 204, Importing vCards (electronic business cards).

**Favourites**: List of destinations stored as favourites.

**Contacts**: List of phone book contacts that have a stored address (postal address).

### Home address

Only one address or position can be stored as the home address at any one time.

Pressing will start guidance to the stored home address.

If a **home address** has not yet been stored, an address can be assigned.

#### Assigning the home address for the first time:

**Position**: Press to store the vehicle's current position as the home address.

**Address**: Press to enter the home address manually.

#### Editing the home address:

The home address can be edited in the **Navigation settings > Manage memory** menu.

### Special destinations (POI)

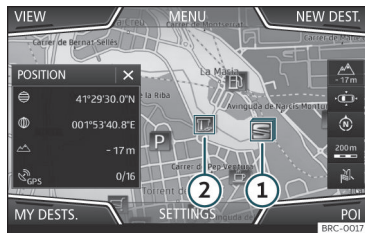

Fig. 165 Points of interest on the map.

The points of interest saved in the memory are divided into different categories. Each category of special destinations has a symbol assigned to it.

If special destinations inherent to the system have been imported >>> [page 204, Importing Personal POI](#) the **Personal POI** category.

In the **Map settings** menu, you can indicate the special destinations that you want to display on the map. Up to 10 categories can be selected.

### Selecting a point of interest on the map

#### Function button: function

- ① There are several points of interest in the area. Press this symbol to open a list of points of interest.
- ② The only point of interest in this zone. Press the symbol to open the detailed view of the point of interest.

### Quick POI search

In the **Navigation** main menu, press the **POIs** function button and the three main categories will appear. Alternatively, enter the name of the point of interest to be searched using the new destination keypad, or press **Search nearby** on the map >>> [table on page 202](#).

### View

In the **Navigation** main menu, press the **View** function button.

#### Function button: function

	Map display in two dimensions (conventional).
	Map display in three dimensions (bird's eye view). The places of interest and well-known buildings are also shown in detail and in colour.
	To display the destination on the map.
	To display the route on the map.
Auto / Day / Night	To switch between day and night format.
SPLIT SCREEN	Show the split screen >>> <a href="#">page 202</a> .
POI	Show special destinations.

<sup>a)</sup> Only displayed with route guidance activated.

## Split screen



Fig. 166 Split screen displayed.

The split screen » Fig. 166 (A) shows the information detailed below:

- Pressing the name displays a menu with the following options:

### Function button: function

**Audio:** Current audio source.

**Compass:** Displays a compass with the current direction and position of the vehicle (street name).

**Manoeuvre:** Displays a list of the next manoeuvres, POIs or TMCs on the route and pressing them brings up additional information

**FREQUENT ROUTES<sup>pl</sup>:** Information on the user's most frequent routes.

### Function button: function

**Position:** current vehicle position in coordinates and GPS status (satellite reception).

- a) Only shown when route guidance is not active or when predictive route guidance is active.

Press the (X) function button to close the split screen.

At any moment during navigation, pressing inside the map will make a pop-up menu appear with the following functions:

### Function button: function

**Clicking on the map:** Shows the details of the selected point, street name or coordinates

Only when you press on an icon on the map:

**POI:** name of the point of interest (when only one appears on the map).

**Group of POIs:** more points of interest (when you press on the map on various POIs grouped together).

**FAVOURITE:** name of the favourite.

**HOME ADDRESS:** Home address.

**Start route guidance:** starts guidance directly.

**Add stopover:** only when you have an active route.

**Search nearby:** enters in the search menu, but only for the area around the point selected on the map.

**Demo mode start** (only when demo mode is active)

## Map display

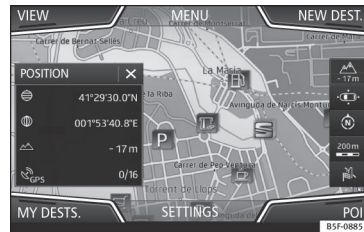

Fig. 167 Messages and function buttons on the map display.





### Function buttons and messages on the map display.

To activate function buttons and , press function button .

### Function button: function

	Current altitude indicator.
	To centre the vehicle position on the map.
	To centre the destination on the map. Only displayed if either <i>Display destination on map</i> or <i>Display route on the map</i> is selected » page 201.
	To change the orientation of the map (north-facing or direction of travel). Only available in 2D mode.

### Function button: function

	Map scale. To change the scale, turn the adjustment knob or move two fingers together or apart on the screen.
	Select the automatic scale. If the function is active, the symbol is displayed in blue.
	Briefly increases the scale of the map (zoom) The selected scale is displayed again after a few seconds.
	Mute or repeat the last announcement, change the announcement volume.

**Road signs:** Depending on the vehicle's equipment, the road signs stored in the navigation data are displayed. Select **Navigation > Settings > Map > Show road signs**.

### Traffic bulletins and dynamic destination guidance (TRAFFIC)



Fig. 168 Traffic reports

The Infotainment system constantly receives traffic reports (TMC/TMCpro) in the **background**, if a traffic information station is tuned.

Traffic bulletins are displayed on the map with symbols >>> page 203, **Traffic reports on map (selection)** and they are required dynamic destination guidance >>> page 203, **Dynamic route guidance**.

#### List of available traffic reports

- Press the Infotainment  button and then select the **Traffic** context.

#### Dynamic route guidance

In order for dynamic route guidance to function, **Dynamic route** must be activated in the route options.

If a traffic report is received that affects the route being travelled, an alternative route will be searched for if the system calculates that time can be saved.

If, on the other hand, the alternative route does not save time, the route will continue with the traffic jam. In both cases, an announcement will be made.

Shortly before reaching the announced traffic jam, it is indicated again.

Avoiding a traffic jam by following the instructions of a traffic bulletin does not always save time, for example, if alternative routes

are congested. The effectiveness of dynamic navigation depends on the traffic bulletins that are received.

The rest of the route that has to be travelled can be manually excluded to force its recalculation >>> page 199.

#### Traffic reports on map (selection)

##### Symbol: Meaning

	: Slow traffic
	: Traffic jam
	: Accident
	: Slippery road surface (ice or snow)
	: Slippery road surface
	: Danger
	: Road works
	: Strong wind
	: Road closed to traffic

During route guidance, traffic incidents that do **not** affect the calculated route calculated are displayed in grey. >>

The length of a traffic jam on the calculated route is shown by a red line.

Incidents that affect the calculated route and that have led to the recalculation of the route are shown in orange.

The position of a symbol indicates the start of the traffic jam if it is precisely specified in the traffic bulletin.

## Predictive navigation

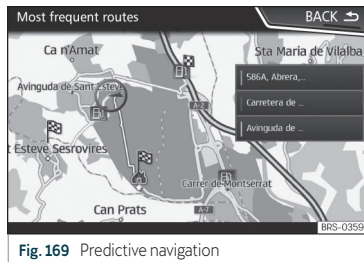

Fig. 169 Predictive navigation

When you activate Predictive navigation, the system detects and stores in the background routes that are frequently followed, without them being active destination routes.

This function has no navigation announcements unless the user requires them, getting them by pressing the settings button.

- On the main screen of the Navigation menu, in the pop-up window, press the **FREQUENT ROUTES** button. To display frequently followed routes press the **Show on map** button >>> **Fig. 169**.

## Importing vCards (electronic business cards)

### Importing vCards to the destination memory

- Insert the data storage device with the stored vCards or connect it to the Infotainment system >>> **page 177**.
- Press the **SETTINGS** function button in the main **Navigation** menu.
- In the **Navigation settings** menu, press the **Import destinations** function button.
- Select the data carrier with the vCards saved in the list.
- Press **Import all vCards from this folder**.
- Confirm the import notice with the **OK** function button.

Saved vCards will now be in the destinations memory >>> **page 199**.

### Note

**Only one address per vCard can be imported. In the event any vCards have multiple**

**addresses, only the main address will be imported.**

## Importing Personal POI

### Importing the Personal POI to a points of interest destination memory

- Insert the data storage device with the stored Personal POI or connect it to the Infotainment system >>> **page 177**.
- Press the infotainment button **F** and then select **Settings > Manage memory**.
- Press **Update my POIs** and then press **UPDATE** and **Next** to import Personal POIs.
- Confirm the import notification with the **OK** function button.

The stored Personal POI are now in the points of interest destination memory >>> **page 201**.



The stored Personal POI can be deleted in the **Navigation settings** menu.

### Navigation with images



Fig. 170 Images main menu.

#### Selecting an image and starting route guidance

- Press the Infotainment  button and then select the **Images** context.
- Press the **SOURCE** >>> **Fig. 170** function button and select the data storage device where the images are stored.
- If the image displayed was taken using GPS localisation, the  function button will appear. Press to start guidance to a destination.

### Road signs indication

The road sign indication must be active in the **Navigation settings** menu >>> page 205.

If there are road signs stored in the navigation data for the route you are driving on, the system can display them on the map (e.g. a speed limit).

Take into account the age of the navigation data and the limitations of the navigation system >>> page 195 !

### Recognition of road signs

Some vehicles have a road sign recognition camera. If the vehicle has road sign recognition and it is active, road signs detected by the system will be displayed on the map, along with additional information.

Read and take into account the information and indications of the road signs recognition system >>> page 70.

### Route guidance in Demo mode

If demo mode is activated in the **Navigation settings** menu, an additional pop-up window opens when you start route guidance.

- Pressing the **Demo mode** function button starts a “virtual route guidance” to the destination you have entered.
- If you press the **Normal** function button, a “real route guidance” starts.

The development and operation of virtual route guidance is compatible with the development and operation of real route guidance.

Virtual route guidance is repeated after reaching the fictitious destination and re-starts from the starting point, if it is **not** interrupted beforehand.

When the starting point of the Demo mode is manually set in the **Navigation settings** menu, the virtual route guidance starts from that position.

A manually entered starting point is overwritten with the current location of the vehicle, if the vehicle starts moving.

#### Note

**Deactivate the Demo mode after use, otherwise you will always have to select whether to start a virtual route or normal route before starting route guidance.**

### Navigation settings

- Press the **SETTINGS** function button in the main *Navigation* menu.

#### Function button: function

**Route options**: To make the route calculation adjustments. >>

## Function button: function

**Suggest 3 alternative routes**: After starting route guidance, 3 alternative routes are proposed »» page 198.

**Route**: Route type selection.

**Economical**: Route calculation, taking economic aspects into account.

**Fast**: The fastest route to the destination.

**Short**: The shortest route to the destination, even if it results in longer travelling time.

**FREQUENT ROUTES**: Information on the user's most frequent routes.

**Dynamic route**: Dynamic route guidance activates when a TMC is received »» page 203.

**Avoid motorways and highways**: Motorways will be excluded from the route calculation wherever possible.

**Avoid ferries and motorail trains**: Ferries and motorail trains will not be taken into account for the route calculation, wherever possible.

**Avoid toll roads**: Toll roads will be excluded from the route calculation, whenever possible.

**Avoid tunnels**: Tunnels will be excluded from the route calculation, whenever possible.

**Avoid routes requiring toll stickers**: Mandatory toll stickers (stickers certifying that the toll has been paid) will be excluded from the route calculation whenever possible.

## Function button: function

**Show available toll stickers**<sup>\*)</sup>: To mark the available toll stickers on the list ( **Avoid routes requiring toll stickers** must be active).

Routes requiring toll stickers will be taken into account in the route calculation if it is marked that the toll sticker is available.

**Include trailer**: Calculate the route and arrival time, depending on whether a trailer is being towed.

**Map**: To adjust the map display settings.

**Show road signs**: The road signs stored in the navigation data for the road you are driving on are displayed during route guidance »» page 205.

**Lane guidance**: During route guidance, an additional indication is displayed to recommend a lane when driving, and when turning on roads with several lanes. Only if the data bank contains information about the area that is being driven through.

**Show favourites**: The destinations saved as favourites on the map are displayed (★).

**Show POIs**

**Select categories for POIs**: To select the POI categories shown on the map »» page 201.

**Show brand logos for POIs**: Displays logos of the selected special destinations categories (e.g. displays logos of service stations).

**Manage memory**: To make adjustments to the stored destinations.

**Sort contacts**: To select the sequential order of agenda entries recorded with postal addresses, see also »» page 199.

## Function button: function

**Define home address**: To assign or edit a home address, see also »» page 201.

**Delete my POIs**: To delete special destinations stored in the POI destinations memory »» page 204.

**Update my POIs**: To update stored POIs »» page 204.

**Import destinations (SD/USB)**: To import digital business cards (vCards) into the destination memory »» page 204.

**Delete user data**: To delete stored destinations (e.g. **Last destinations** or the **Destination memory**).

**Navigation announcements**: To change the navigation announcements settings.

**Volume**: To adjust the volume of audible driving recommendations.

**Entertainment (Navigation announce.)**: Set the volume of the active audio source during navigation announcements.

**No navigation announcements during calls**: During a telephone conversation, audio driving recommendations will not be given.

**Note: My POIs**: Audible warning when approaching a special destination.

**Fuel options**: To change fuel related settings.

**Select preferred petrol station**: The brand of the selected service station is given priority in special destination search results.

**Fuel warning**: The fuel warning is active.



## Function button: function

If the fuel level reaches the reserve, an appropriate warning is generated that enables the service station search.

**Version information**: Information about stored navigation data.

**Maximum speeds**: Shows the speed limits, depending on the road, of the country that is being driven through.

**Advanced settings**: For making advanced changes to the navigation settings.

**Time display**: Indication ⌚ during route guidance.

**Time of arrival**: The estimated time of arrival at the destination is displayed.

**Running time**: The envisaged travelling time to the destination is displayed.

**Status line**: View 📍 during route guidance.

**Destination**: The calculated distance to the destination is shown.

**Next stopover**: The calculated distance to the next stopover is shown.

**Note: National border crossed**: Indication of the speed limits of the country in question when crossing a border.

**Demo mode**: When the Demo mode is active and route guidance is started, a virtual guide to the entered destination may be started >>> page 205.

## Function button: function

**Define demo mode starting point**: If the Demo mode is active and the vehicle is stopped, a fictitious starting point can be set for the virtual route guidance.

**Waypoint mode<sup>1)</sup>**: To start Offroad navigation.

- a) This functionality will depend on the country.
- b) Only available on model: Navi System Plus.

## Navigation in Offroad mode\*<sup>1)</sup>

### Introduction

Offroad\* navigation is a function for offroad driving that provides directions in “non-digitised areas” at low speeds.

*Non-digitised areas* are areas about which the system does not have information for the streets or terrain. It does not detect streets, buildings or natural limits such as mountains or rivers, although they may be shown on the map.

Offroad\* navigation is not suitable for driving on conventional roads as it does not detect one-way streets, motorway entries or similar.

## Offroad Navigation Menu

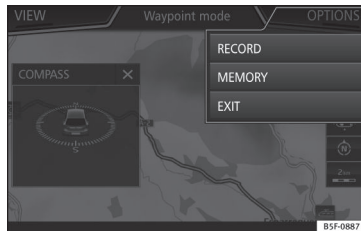

Fig. 171 Offroad Navigation Menu start

Press the **SETTINGS** function button in the main Navigation menu.

- In the menu, press the **Waypoint mode** function button.
- The Offroad Navigation menu opens >>> Fig. 171.

### Function buttons in the Offroad Navigation menu

#### Function button: function

**RECORD**: Initiates the plotting of an Offroad tour.

**MEMORY**: Opens a list allowing the selection of a stored Offroad tour.

**EXIT**: Ends Offroad navigation.

<sup>1)</sup> Only available for the model: Navi System Plus

## Recording an Offroad tour

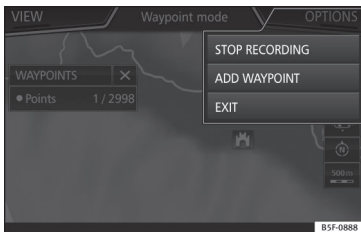

Fig. 172 Recording an Offroad tour

An Offroad tour is formed by a series of stored waypoints.

### Starting recording

- In the Offroad Navigation menu, in the pop-up window press the **RECORD** pop-up button.
- In the pop-up window, the user is able to plot the tour with a given destination or start plotting the route without giving a final destination.
- Starts plotting the route.

The **offroad** markers can be recorded by indicating a manual waypoint.

- In the Offroad Navigation menu, press the **ADD WAYPOINT** function button. The tour

waypoints defined manually are shown on the map by a marker.

### Ending recording

- Press the **STOP RECORDING** function button in the main Offroad Navigation menu.

## Managing stored Offroad tours

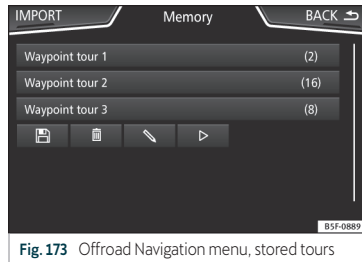





Fig. 173 Offroad Navigation menu, stored tours

- Press the **MEMORY** function button in the Offroad Navigation menu.
- A list of stored Offroad tours opens, if there are any.

When a tour is selected, the following icons will appear >>> **Fig. 173**:

-  Export the tour to an SD card.
-  Edit the name of the tour.
-  Delete the tour.

- ▷ Load tour

### Function button: function

**IMPORT**: allows the import of an Offroad route in ".GPX" format.

### Loading an Offroad tour

When the Offroad tour is selected, press Play ▷ and the selected tour will be loaded onto the Navigation system.

## Creating an Offroad tour

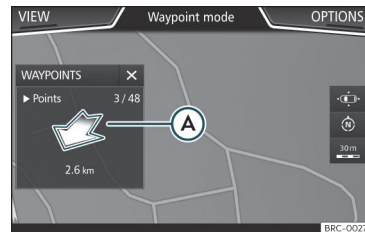

Fig. 174 Offroad route guidance mode

### Start route guidance

- Loads the stored Offroad tour.
- Starting off in a stored route is not detected by the system automatically.

## Setup

### Function button: function

**INVERT**: Reverses the direction of the stored Offroad tour.

**NEXT POINT**: Starts the Offroad tour from the nearest point.

**Start**: Starts the complete Offroad tour.

When route guidance starts, the system switches to the map view.

## Stopping route guidance

- Press the **Options** button on the screen and then press **Stop**.

## End waypoint navigation

- Press the **EXIT** function button in the Off-road Navigation menu

### **WARNING**

**Terrain features are disregarded during route guidance Drive slowly and following the instructions in order to perform the manoeuvre as far as possible!**

- The general direction of travel is indicated straight ahead by direction arrows in the Infotainment System pop-up window >>> Fig. 174 (A).

### **Note**

If an Offroad tour is being recorded, this is automatically stored if Offroad navigation is discontinued.

## Vehicle Menu

### Introduction to using the Vehicle menu

By pressing button **☰** of the infotainment system you will access its main menu with the following options:

- VIEW
- RADIO or MEDIA (to control playback in radio or media mode)
- HDC (displayed if the descent assistant is active) >>> page 239
- PREVIOUS-NEXT (to change screen)
- SETTINGS >>> page 80

With the **View** function button you can access the following information:

- INSTRUMENT PANEL >>> page 209
- SPORT\* >>> page 210
- OFFROAD\* >>> page 210
- CONSUMERS >>> page 211
- DRIVING DATA >>> page 211

- ECOTRAINER >>> page 212
- VEHICLE STATUS >>> page 213

## Instrument panel\*

- ✓ Valid for vehicles fitted with a Digital Cockpit



**Fig. 175** Instrument panel

Press the **Instrument panel** button to choose from the various display options and customise the information that appears in the SEAT Digital Cockpit >>> page 63.

### Automatic View

Pre-set information depending on the *Driving mode*.

### Classic View

The needles are displayed at full length. »

## Views 1, 2, 3

Customise the information that appears in the digital cockpit. The user chooses which to display, and in what order, by moving a finger vertically over the dials.

Depending on the version, the **Views** can be memorised by existing the menu or keeping the **View** button pressed.

## Sport\*



Fig. 176 SPORT menu

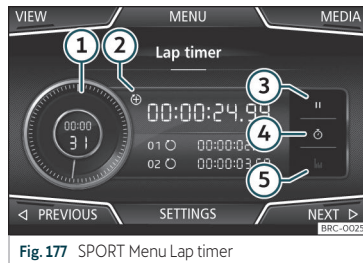



Fig. 177 SPORT Menu Lap timer

- Press the infotainment button .
- Press the **VIEW** function button and select **SPORT**.

If the corresponding equipment is available, the following information appears in the Sport option >>> Fig. 176:

1. Instantaneous power expressed in kW
2. G forces
3. Turbo pressure, expressed in bar ("bar"), kilopascals ("kPa") or in pounds per square inch ("psi"). Press the Settings button to change the units of pressure >>> page 154
4. Coolant temperature
5. Oil temperature

Only 3 of these items of information can be displayed at the same time, but the user

chooses which to display, and in what order, by moving the finger vertically over the dials.

Press the **Next** button to bring up the **Lap timer** menu, which is described below >>> Fig. 177:

- ① Analogue lap timer
- ② New timing is started by pressing on the surface of the digital lap timer +.
- ③ Stop lap timer /Lap time.
- ④ The analogue lap timer's time is stopped for 5 seconds. After 5 seconds, the analogue lap timer shows the real time again.
- ⑤ Statistics/delete last lap time.

## Offroad\*



Fig. 178 Offroad CAR Menu.

- Press the infotainment button .

- Press the **VIEW** function button and select **OFFROAD**.

If the corresponding equipment is available, the information that appears is the following:

1. Compass.
2. Turning angle of steered wheels.
3. Coolant temperature.
4. Lubricating oil temperature

Only 2 of these items of information can be displayed at the same time, but the user chooses which to display, and in what order, by moving the finger vertically over the dials.

### Consumers

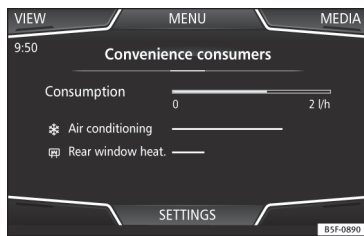

**Fig. 179** Convenience consumers.

Access information about the vehicle's main convenience consumers. It is shown via a consumption indicator bar in l/h (gal/h).

### Driving data

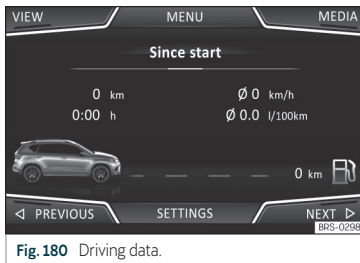

**Fig. 180** Driving data.

The on-board computer has 3 memories. They can be used to display: distance, time, average speed, average consumption and range.

#### 1. Since start

Indication and storage of distance travelled and consumption values between the ignition being turned on and it being turned off.

#### 2. Since refuelling

Display and storage of the values for the journey and the consumption. By refuelling, the memory will be erased automatically.

#### 3. Long-term

The memory records the values for a specific number of partial trips, up to a total of 19

hours and 59 minutes or 99 hours and 59 minutes, or 1999.9 km (mi) or 9999 km (mi), depending on the model of instrument panel.

When one of these values is reached (depending on the version of the instrument panel), the memory is automatically deleted and starts counting again from 0.

## Ecotrainer

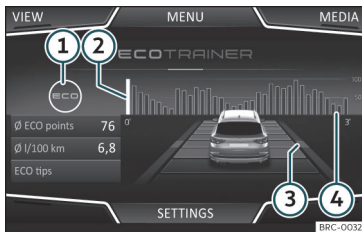

Fig. 181 CAR Ecotrainer menu.

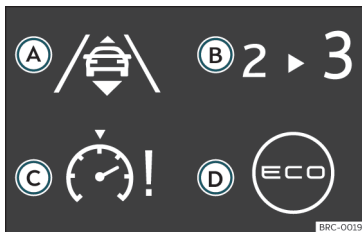



Fig. 182 Driving style symbols.

### Open the ECOTRAINER Menu

- While the vehicle is stopped, press the Infotainment button .
- Press the **VIEW** function button and select **ECOTRAINER**.

Provides information about your driving style. The information on driving style is only evaluated and displayed when moving forward.

### Ø ECO points: indication on driving style

Indicates driving style efficiency since start on a scale of 0 to 100. The higher the value displayed, the more efficient the driving style. Press on the display for more information. Statistics are shown for the last 30 minutes of driving from the start. If 30 minutes have not elapsed, the values of the last trip are shown in grey.

### Ø l/100 km: Average fuel consumption

Shows the average fuel consumption. The value is calculated using the kilometres travelled since start as a reference. Press on the display for more information. Statistics are shown for the last 30 minutes of driving from the start. If 30 minutes have not elapsed, the values of the last trip are shown in grey.

### Eco tips: Tips on how to save fuel

Press the **ECO tips** button to get advice on how to save fuel. These tips can only be consulted while the vehicle is stopped.

### Efficient driving style assessment

The representation uses different elements to show driving style efficiency.

### Indication »» Fig. 181: Meaning

- |   |   |
|---|---|
| ① | To the left of the columns are different symbols that provide information about the current driving style »» table on page 212.   |
| ② | The white column is an indication of where the efficiency graph starts (from left to right). It shows the position of the evaluation that is currently being performed.   |
| ③ | Bars to illustrate acceleration. The position of the car represents acceleration. If the speed is constant, the car remains in the central zone. If it accelerates or brakes, the car moves backwards or forwards respectively.   |
| ④ | Columns representing driving style efficiency. Horizontally, the columns represent retrospective driving efficiency, and move from left to right approximately every 5 seconds. The higher the columns, the more efficient the driving style. The colour of the sky represents the average of the last 3 minutes. The colour changes from grey (less efficient) to blue (more efficient). |

### Symbols »» Fig. 182: Meaning

- |   |   |
|---|---|
| A | Thinking ahead. Sudden changes in acceleration lower the efficiency of the driving style. |
| B | Gear recommendation.  |
| C | Current speed has a negative impact on fuel consumption.                                  |
| D | Ecological driving style.   |

### Vehicle status

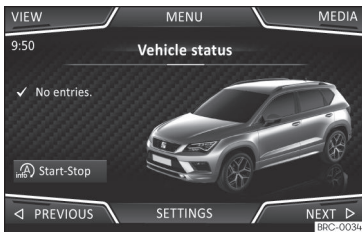

Fig. 183 Standard representation: vehicle status.

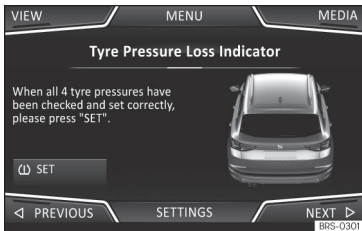

Fig. 184 Standard representation: vehicle status.

Press the **(Vehicle status)** button to access information on the **Vehicle status** messages and **Start-Stop system**.

The **Vehicle status** messages are displayed >>> Fig. 183, in addition to being specified on the corresponding button.

According to the parties affected by these messages, they will be shown in different colours (depending on their importance) on the vehicle's screen.

To access the **Tyre Pressure Monitoring System** screen, press the **(Previous)** or **(Next)** keys.

From this same menu, use the **(SET)** button to store the tyre pressures.

#### Note

The values shown on the figures >>> Fig. 179, >>> Fig. 180, >>> Fig. 183 and >>> Fig. 184 are indicative and may vary depending on the equipment.

## Telephone

### General information

Telephone functions can only be used if there is a mobile phone connected by Bluetooth to the infotainment system >>> page 215.

To do this, the phone must have the **Bluetooth®** function activated.

The instructions shown on the screen for the telephone menus will depend on the mobile telephone used.

Only use compatible Bluetooth® devices. For further information on compatible Bluetooth® products, ask your nearest specialised CUPRA dealer, any SEAT dealership or check on the internet.

Use the instruction manual of the mobile telephone and of any accessories.

If you detect any operating issues between your mobile telephone and the Infotainment system, restart your mobile by switching it off and on again.

Some functions and setup can only be performed when the vehicle is stopped and are not available on all mobile telephones.

You may experience poor reception or may be cut off in areas where the signal is weak.

Most electronic devices are shielded against HF (high-frequency) signals. In any case, the electronic equipment may not be protected from the HF signals of the telephone management system. This may cause interference.

#### WARNING

General, mandatory, legal and country-specific instructions and laws for the use of mobile phones inside the vehicle must always be considered. »

### WARNING

Speaking by telephone and using the mobile telephone management system whilst driving can distract you from the road and cause an accident.

- In areas of little coverage your call may be cut off and you may not be able to make even emergency calls.

### WARNING

Mobile telephones may interfere with and alter the correct operation of pacemakers if they are carried directly over them.

- Maintain a minimum distance of at least 20 centimetres between the aerials of the mobile telephone and the pacemaker.
- Do not carry your switched-on mobile telephone in your breast pocket directly over the pacemaker.
- If you suspect interference, switch off the mobile telephone immediately.

### CAUTION

High speeds, poor weather or road conditions and the quality of reception can all affect the audio quality of a telephone conversation in the vehicle.

### Note

- Restrictions on the use of devices using Bluetooth® technology may apply in some

countries. For further information, contact the local authorities.

- If you wish to connect a device via Bluetooth®, consult the safety warnings in its instruction manual. Only use compatible Bluetooth® devices.
- Using a mobile telephone inside the vehicle may provoke noise in the speakers.
- Some networks may not recognise all of the language characters or offer all of the services.

### Places with special regulations

In the majority of cases, these places are signposted, but not always clearly. They include, for example:

- the vicinity of chemical pipelines and tanks
- The lower decks of boats and ferries.
- In the proximity of vehicles that run on liquid gas (such as propane or butane).
- places where the air is laden with chemicals or particles such as flour, dust or metal powder.
- all other places where the vehicle engine must be switched off.

### WARNING

Switch off the mobile phone in areas with a risk of explosion! The mobile telephone

can automatically connect to the mobile telephone network again if it loses the Bluetooth® connection to the telephone management system.

### CAUTION

In areas where special regulations apply or the use of mobile telephones is prohibited, both the telephone and the telephone management system must always be switched off. Interference may be caused with sensitive technical and medical equipment, possibly resulting in a malfunction or damage to the equipment.

### Bluetooth®

Bluetooth® technology allows a mobile telephone to be connected to your vehicle's telephone management system. Prior pairing between the two is required for this purpose.

Some Bluetooth® mobile telephones connect automatically when turning on the ignition if a connection has been previously established. Its Bluetooth® function must be activated for this purpose, and there must be no Bluetooth® connection with other devices.

Bluetooth® connections are free.

Bluetooth® is a registered trademark of Bluetooth® SIG, Inc.



### Bluetooth profiles®

When a mobile phone is connected to the telephone management system, a data exchange takes place via one of the Bluetooth® profiles.

- **Hands-free telephone profile (HFP):** the HFP can be used to manage calls through the infotainment system.
- **Audio profile (A2DP):** This profile allows audio to be transmitted with stereo quality. It may require connecting other profiles for managing and controlling playback.
- **Phone book access profile (PBAP):** Allows phone book contents to be downloaded from the mobile telephone.
- **Message profile (MAP):** It allows short messages (SMS) to be downloaded and synchronised.

#### Note

The mobile telephone's button and warning tones should be off. Where necessary, disconnect the headset from the mobile telephone you wish to connect to the system.

### Pairing and connecting a mobile telephone to the Infotainment system

In order to manage a mobile telephone via the Infotainment system, it is necessary to pair both devices **once**.

For your safety, pairing should be done when the vehicle is stationary. In some countries it is not possible to perform the pairing with the vehicle running.

#### Conditions

- The ignition must be switched on.
- The **Bluetooth® function** of the mobile phone and the Infotainment system must be active and visible.
- The **keypad lock** on the mobile telephone must be deactivated.

Follow instructions in the manual for the mobile telephone.

During the pairing process, it is necessary to enter data via the mobile telephone's keypad.

#### Pairing a mobile telephone

- Press the infotainment button  > **Find telephone > Results**.

OR:

- Press the infotainment button  > **Settings > Select mobile phone > Results**.

OR:

- Press the infotainment button  > **Settings > Bluetooth > Find devices > Search results**.

OR:

- Make the connection from the settings menu of the mobile phone itself.

The name of your Infotainment system will be displayed on the main *Telephone* screen and you can edit this name via the **Bluetooth settings** menu.

The search process can take up to 1 minute.

As soon as the search is completed, the names of the Bluetooth® devices found are displayed on-screen.

- Select the Bluetooth® device you want to connect. Additional data may need to be entered.
- Use your mobile telephone to enter and confirm your PIN code, as indicated in the display of the infotainment system.
- If more Bluetooth® profile pairing requests are received on the mobile telephone, make sure to reply to them. »

OR:

- Compare the PIN code shown on the display of the Infotainment system with the one shown on the mobile phone. If they match, confirm on **both** devices.

Now, the infotainment system and the mobile phone will be connected to each other.

When the pairing has been finalized correctly, the *Telephone* main menu will appear.

The phone book, call list and SMS messages stored in the mobile phone will be loaded once the requests have been accepted in the mobile phone. After downloading, the data will be available on the Infotainment system.

## Pairing and connection of mobile telephones

You can pair up to 20 mobile telephones to the Infotainment system, but the number of simultaneous connections varies:

- *Media System Plus / Navi System*: two mobile phones simultaneously connected to the hands-free profile, and one of them as Bluetooth® audio.
- *Navi System Plus*: two mobile phones simultaneously connected to the hands-free profile and one of them or a third one connected to the Bluetooth® audio.

When the Infotainment system is switched on, it connects to the last connected mobile

telephone. If it is not possible to connect to this mobile telephone, the system will try to connect to the next mobile telephone on the list of paired devices.

The **maximum** range of the connection is approx. **10 metres**. The connection will be interrupted if this distance is exceeded. The connection is **automatically** re-established as soon as the device is once again within Bluetooth® range.

If the maximum number of paired devices is reached and you want to pair another one, the system will automatically replace the least recent one with it. If it is to replace another one, the user must delete that one first. Do do this:

- Press the **SETTINGS** function button in the telephone context.
- Press the function button **Bluetooth settings > Paired devices**.
- In the list of linked devices, press the function button  after the mobile phone to be deleted, and then press **Delete** to confirm the process.

### WARNING

**Do not perform the pairing and connection process while driving. This may cause an accident!**

### Note

**Check that there are no requests pending acceptance in your mobile phone. If there are, this could block some of the functions in the Telephone menu.**

## Telephone main menu



Fig. 185 Phone main menu.

## Assign a user profile

The phonebook, the call lists and the speed dial buttons are assigned to a user profile and remain stored on the telephone management system. This information will be available every time the mobile telephone is connected.

After the first connection, it will take a few minutes for the data from the linked mobile phone to be available in the system. The next

time that the mobile telephone is connected the phonebook is updated automatically.

If the mobile phonebook has been modified while connected, a manual update of the phonebook data can be started from the **User profile settings** menu.

Telephone management can store a maximum of 4 profiles for mobile phones. If you wish to pair another mobile phone, the oldest user profile will be replaced.

### Telephone management system function buttons

- Press the infotainment button  to open the *Phone* main menu.

#### Function button: function

①	Name of connected mobile telephone. Press the icon to the left to connect another mobile phone.
②	Speed-dial buttons, connected telephone contacts favourites.
③	To change to another telephone connected to the hands-free profile. Only visible when there are two telephones connected as hands-free.
DIAL NO.	Open the numeric keypad >>> page 218.
CONTACTS	To open the phonebook of the connected telephone.

#### Function button: function



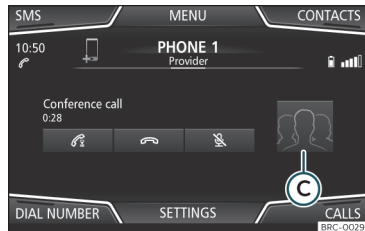
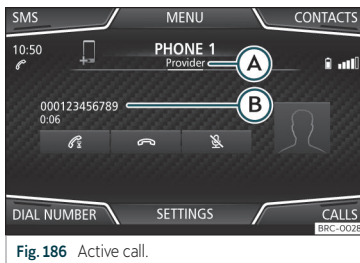

Text message	To open the SMS menu.
CALLS	To open call lists of the connected mobile telephone >>> page 221.
SETTINGS	To open the <b>Phone settings</b> menu.

### Instructions and symbols of the phone management system









**Fig. 187** Conference call.

### Display: Meaning >>> Fig. 186

A	Name of the mobile operator of the connected device.
B	Stored telephone number or name. If the name stored in the phonebook has an assigned photo, it can be displayed: select <b>Telephone &gt; Settings &gt; User profile &gt; Show pictures for contacts*</b> .
	To accept a call.
	To end a call.
	<b>OR:</b> To reject an incoming call.
	To mute or to reactivate the ring tone during an incoming call.
	To mute the microphone during an active call and to reactivate it.

>>

## Display: Meaning >>> Fig. 186

	The active call is put on hold. While on hold the listener will not hear the conversation. To reactivate it, press the call accept button  . To reject it, press the reject button  .
	Press to add a participant to the active call.
	Connected mobile telephone charge status.
	Strength of the signal received by the mobile telephone.

### Multiple calls

The telephony management system allows the user to interact with up to three calls on the screen.

Only one of the calls can be active.

### Conference call

The user can merge several calls into a single one by making a conference call by pressing button . There must be a minimum of two calls for this to work. Once the conference call has started, the user can add up to 5 participants.

Once the conference call is established, the user can consult the list of participants by pressing on the conference call image >>> **Fig. 187** .

Depending on the mobile device, the call from a conference call participant can be

hung up or excluded from the conference call but kept on a separate call.

### WARNING

**Remember that the driver should not operate the mobile phone while driving.**

### Note

**Multi-call and conference call functionalities are subject to the services associated with the user's SIM card.**

## Enter telephone number menu

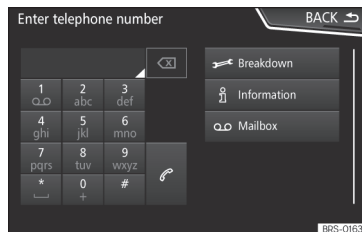

**Fig. 188** Enter telephone number menu.

• Press the  function button from the *Telephone* main menu.

### Enter telephone number

• Enter a phone number with the keypad. Press the  function button to make a call.

### Select a contact from the list

• Enter the first few letters of the contact. The available entries appear in the phone-book.  
• Select the desired contact to make the call.

### Enter the country code

• Press the function button **0** for approx. 2 seconds to add the +.

### Assistance call

• Press the function button to obtain help in the event of breakdown.

### Information call

• Press the function button to obtain information on the CUPRA brand and the additional contracted services.

### Call mailbox

• Press the function button to make the call.  
• **OR:** Press the  function button for about 2 seconds to make a call.

### Note

- Breakdown service and information calls can incur an additional cost on your telephone bill.
- The Roadside Assistance and Information services might not work properly, for example, if the vehicle and the operator of the connected mobile telephone are in different countries. If you are not able to use these services contact an authorised CU-PRA workshop.

### Phonebook Menu (contacts)

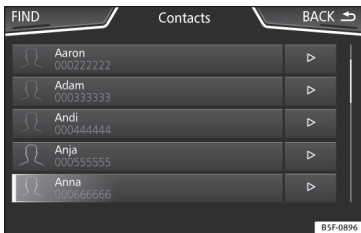

Fig. 189 Contacts Menu.

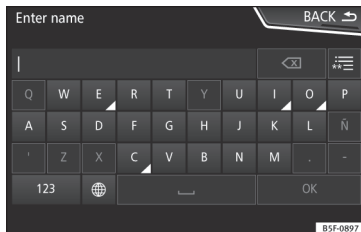

Fig. 190 Search window.

Once the first pairing is made, it may take some time until the phonebook data<sup>1)</sup> of the paired mobile are available in the infotainment system. Depending on the volume of data that has to be transferred, the process may take several minutes. It may be necessary to confirm the data transmission on the mobile phone.

The phonebook can also be viewed during a telephone conversation.

If the name saved in the phonebook has an assigned photo, it can be displayed on the list next to the name. To do this, the option **Show pictures for contacts** in the **Phone settings** context must be enabled and your mobile phone must support this functionality

(check the compatibility list) >>> page 222, Phone settings.

In the **Telephone** main menu, press the **Contacts** function button to access the contacts list.

### Select a contact from the list

- Search the list and press on the desired contact to make the call.
- **OR:** If the contact has several numbers, first press on the contact and then press on the desired number for making the call.

### Search for a contact in the search window

- Press the **Search** function button >>> Fig. 189 to open the search window.
- Enter the name of the contact you are looking for in the window >>> Fig. 190. While the characters are being entered, a contact is displayed in the input field.
- The number of matching results is displayed to the right of the input field. Press the function button to go to the list.
- Search the list and press on the desired contact to make the call.

<sup>1)</sup> Depending on the device, only contacts in the phone's memory are loaded.

## Opening the detailed view of a contact

- Press the function button **▷ >>>** **Fig. 189** located next to the entry on the contacts list.

All the telephone numbers are displayed in the detailed view, and where applicable, the address recorded for the contact in question.

## Read contact name

- Press the function button **🔊** on the detailed list if you want the voice control system to read the name of the contact.

## Call a contact

- Press the desired telephone number on the detailed list to make the call.
- Press the **✎** icon to edit the number before calling.

## Send SMS to a contact

- Press the function button **✉** on the detailed list.

## Start route guidance to a contact's address<sup>1)</sup>

If the contact's address data has been saved, route guidance can be started to the contact's address.

- Press address data in the detailed view to start route guidance.

### Note

**If you edit a number before calling, it will not be saved in the phonebook but only used for the call.**

## Short messages (SMS) menu

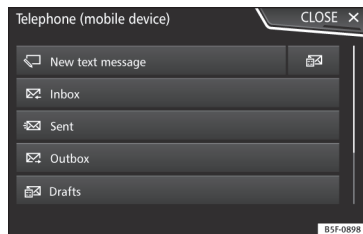

**Fig. 191** Short messages (SMS) menu.

If the mobile phone connected to the HFP profile also supports the SMS profile, a new function button will appear in the upper left corner of your *Telephone* menu, which will allow you to receive, view and send SMS messages through the infotainment system.

Whether or not the aforementioned functions work correctly will depend on the compatibility of the connected mobile phone.

## SMS menu function buttons

- Press the **SMS** function button from the *Telephone* main menu.

### Function button: function

New text message	To write and send an SMS (includes the possibility of accessing preset text templates).
Inbox	To open the received SMS folder.
Outbox	To open the outbox folder. SMS messages that have not been sent are stored here.
Sent	To open the sent SMS folder.
Drafts	To select a message that has been stored but not sent.
Send contact details	To send the details of a contact from the contact list.

## Possible submenu function buttons

### Function button: function

READ OUT	For the voice control system to read the text of the SMS.
----------	---

<sup>1)</sup> Valid for Navi System and Navi System Plus.

## Function button: function

<b>Options</b>	Open the <b>Options</b> menu.
<b>Reply with template</b>	To select a text template from a list.
<b>Delete current text message</b>	The SMS is deleted from the <b>Inbox</b> folder.
<b>Telephone number</b>	The sender's telephone number is displayed.
<b>FORWARD</b>	To forward an SMS.
<b>REPLY</b>	To reply to an incoming SMS.
<b>Enter number</b>	To enter a telephone number or to select a recipient from the contact list.
	Press the <b>Recipients</b> function button to select multiple recipients.
<b>Recipients</b>	To select multiple recipients from the contact list.
<b>Delete</b>	To delete an SMS.

## Calls Menu (call lists)

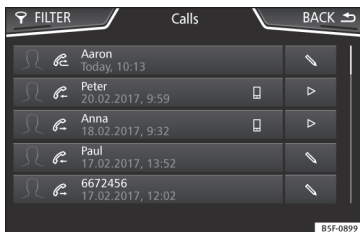

Fig. 192 Call lists menu.

- Press the **Calls** function button from the *Telephone* main menu.
- Press the **FILTER** function button.
- Select the desired call list: **All calls**, **Missed calls**, **Calls** or **Received calls**.

If a telephone number is stored in the phone book, the saved name is displayed on the call list instead of the number.

If a photo is assigned to the name stored in the phonebook, it can be displayed on the call list next to the name » page 222.

### Possible displays in the Calls menu

#### Display: Meaning

	<b>Missed calls</b> : Missed and unanswered calls.
	<b>Calls</b> : Dialed numbers.

#### Display: Meaning

**Received calls**: Received calls.

#### Note

The availability of the call lists will depend on the mobile phone used.

## Quick dial keys



Fig. 193 Quick access to the phone book.

The speed dial keys »»» **Fig. 193 1** can be assigned a telephone number from the phone book.

If a photo is assigned to the name stored in the phone book, it can be displayed on the speed dial button »»» page 222.

All speed dial keys have to be manually edited and will be assigned to a user profile. Up »»

to 12 contacts can be added to the speed dial keys.

## Assign the speed dial keys

- In the main *Telephone* menu, press a **free** speed dial key.
- Select the desired contact from the list. If the selected contact has several phone numbers, select the number you want.

## Edit assigned speed dial keys

- *Press and hold* an **occupied** speed dial key in the *Telephone* main menu until the *Contacts* menu opens.
- Select the desired contact from the list. If the selected contact has several phone numbers, select the number you want.
- To close the *Contacts* menu without applying the changes, press the **BACK** function button.

## Delete assigned speed dial keys

- The phone numbers stored in the speed dial buttons can be deleted in the menu **User profile settings > Manage favourites >>>** page 223.

## Make a call with a speed dial button

- *Briefly press* an **assigned** speed dial key in the *Telephone* main menu to call the telephone number stored in it.

### Note

The contacts stored in the speed dial keys are **NOT** updated automatically. If a contact stored on a speed dial key is modified on the mobile phone, the speed dial key must be assigned again.

## Phone settings

In the *Telephone* main menu, press the **SETTINGS** function button.

### Function button: function

**Private mode**: Private mode can only be activated during an active call. When private mode is disabled (by default), the call's audio is managed through the vehicle. When private mode is activated, call audio is managed through the mobile phone.

**Select mobile phone**: From the list, select the mobile phone to be connected to the hands-free profile with the infotainment system.

**OR**: Press **Find telephone** to connect a new mobile phone.

**Bluetooth®**: Opens the menu **Bluetooth® settings >>>** page 222.

**User profile**: Open the **User profile settings** menu >>> page 223.

### Note

Some telephones require a restart to download the last added contacts again.

## Bluetooth® settings

In the main *Telephone* menu, press the **SETTINGS** function button and then press the **Bluetooth®** function button.

### Function button: function

**Bluetooth®**: Press to deactivate Bluetooth®. All active connections are disconnected.

**Visibility**: Activating and deactivating Bluetooth® visibility.

**Visible**: Bluetooth® visibility is active.

**Hidden**: Bluetooth® visibility is deactivated. Bluetooth® visibility must be active for external pairing of a Bluetooth® device with the infotainment system. When a Bluetooth® audio device is active and playing, visibility is automatically set to **Hidden**.

**Forename**: Display or change the Bluetooth® name of the infotainment system. This will be the name shown to other Bluetooth® devices.

**Paired devices**: Viewing paired devices. To disconnect and connect Bluetooth® devices and Bluetooth® profiles.

**Find devices**: Search for visible Bluetooth® devices that are within range of the infotainment system. The **maximum** range is approx. **10 meters**.

**Bluetooth® Audio (A2DP/AVRCP)**: If an external audio source is to be connected to the infotainment system via Bluetooth®, this function must be active >>> page 189.



## User profile settings

In the main *Telephone menu*, press the **SETTINGS** function button and then press the **User profile** function button.

### Function button: function

**Manage favourites**: Edit the speed dial keys.

**Occupied speed dial key**: Press to delete the stored number.

**Free speed dial key**: Press to save a phone book number on the speed dial key.

**Mailbox number**: To enter or change the voice mailbox number.

**Sort by**: To set the order of appearance of the phone book entries (**Forname** and **Surname** or vice versa).

**Import contacts**: Press to import the phone book of the connected telephone or to update the imported phone book.

**Reminder: remember your mobile phone**: If a Bluetooth® connection is active with a mobile phone, the message **"Do not forget your mobile phone"** appears when the ignition is switched off.

**Show pictures for contacts**<sup>a)</sup>: If the contacts in the phone book have been saved with a photo, it can be displayed on the speed dial keys, call lists and phone book.

<sup>a)</sup> Depending on the mobile phone.

### Note

Some telephones require a restart to download the last added contacts again.

## Multimedia

### USB/AUX-IN input.



Fig. 194 Centre console: USB/AUX-IN input.



Fig. 195 Rear part of the centre console: USB connectors.

Depending on the special characteristics and the country, the vehicle may have a USB/AUX-IN port.

The USB/AUX-IN port can be found in the storage compartment area of the centre console >>> Fig. 194.

Depending on the equipment and the country, the vehicle may also have USB connections **exclusively for charging or as a power socket**.

These USB ports are located at the rear of the console, between the front seats >>> Fig. 195.

### Connectivity Box\* / Wireless Charger\*



Fig. 196 In the centre console: pad for the mobile phone connection.

The Connectivity Box includes different functions that will help to use your mobile device.

They are the “Wireless Charger” and the “Mobile Signal Amplifier”.

The Wireless Charger only features the “Wireless Charger” function.

#### “Wireless Charger”

The “Wireless Charger” allows mobile devices with Qi<sup>1)</sup> technology to be charged without a cable.

To charge your mobile phone wirelessly:

<sup>1)</sup> Qi technology allows you to charge your mobile phone wirelessly.

- Place your mobile device in the middle of the pad with the screen facing up >>> **Fig. 196** >>> .

Make sure there are no objects between the pad and the mobile phone.

The mobile phone will start charging automatically. For further information about whether your mobile device supports Qi technology, check your phone's user manual or visit the CUPRA website.

### “Mobile Signal Amplifier”

The “*Mobile Signal Amplifier*” allows you to reduce the radiation in your vehicle and enjoy better reception.

For safety reasons, it is recommended that you pair the system and the mobile using Bluetooth® and place it on the Connectivity Box pad, for the best reception without having to handle the mobile phone.

To establish a connection with the vehicle's external aerial:

- Place your mobile device in the middle of the pad with the screen facing up >>> **Fig. 196** >>> .

Make sure there are no objects between the pad and the mobile phone.

Your mobile phone will automatically be ready to make use of the external aerial.

### WARNING

- The mobile phone may heat up due to the wireless charging. Think about this before you pick it up, and take care when removing it.
- There must be no metallic or other objects between the mobile phone and the housing, to prevent the functionality of the Connectivity Box from being affected.

### Note

- Your mobile device must support the Qi inductive charging interface standard for proper operation.
- The charging time and the temperature vary in accordance with the device used.
- The maximum charging capacity is 5 W.
- Qi technology does not allow you to charge more than one mobile device simultaneously.
- No improvement in reception can be guaranteed if there is more than one mobile phone on the pad.
- You are advised to keep the engine running to guarantee proper wireless charging.
- When a telephone with Qi technology is connected by USB, it will be charged by the means specified by the manufacturer.

## Driving

### Start and driving

#### Starting and stopping the engine

##### Ignition and start button



**Fig. 197** In the lower part of the centre console: start button.

The engine can be started with a start button (Press & Drive). To do so, there must be a valid key inside the vehicle in the area of the front or rear seats, or on the centre console.

In vehicles with the Keyless Access >>> page 87 system, the engine can also be started with the key in the luggage compartment.

Opening the driver's door **when exiting the vehicle** activates the electronic lock on the steering column if the ignition is disabled.

##### Switching the ignition on/off manually

If you only want to switch on the ignition (without starting the engine), briefly press the start button once **without pressing** the brake pedal or the clutch pedal >>> .

The start button text **START ENGINE STOP** flashes like a heartbeat when the system is ready for the ignition to be turned on or off.

##### Automatic ignition disconnection

If the driver leaves the vehicle, taking the key with them but leaving the ignition on, the ignition does not switch off automatically. The ignition is switched off by pressing the lock button on the remote control  or by pressing the sensor surface on the door lever >>> **Fig. 72**.

##### Automatic deactivation of the ignition on vehicles with the Start-Stop system

The ignition is switched off automatically when the vehicle is stopped and the automatic engine shutdown is active, if:

- The driver's seat belt is not fastened,
- the driver does not step on any pedal,
- the driver door is opened.

After automatically turning off the ignition, if the dipped beam  is on, the side light remains on for approx. 30 minutes (if there is enough charge in the battery). If the driver locks the vehicle or manually turns off the light, the side light goes out.

##### Engine restart feature

If no key is detected inside the vehicle after the engine stops, you will only have 5 seconds to restart it. A warning will display on the dash panel screen.

After this interval, it will not be possible to start the engine without a valid key inside the vehicle.

##### WARNING

When switching on the ignition, **do not** press the brake or clutch pedal, otherwise the engine could start immediately.

##### WARNING

If vehicle keys are used negligently or without due care, this may cause accidents and serious injury.

- Never leave any key inside the vehicle when you leave it. Otherwise, a child or unauthorised person could lock the vehicle, start the engine or connect the ignition and operate any of the electrical equipment.

**Note**

- Before leaving the vehicle, always disconnect the ignition and, if appropriate, take into account the instructions on the screen of the dash panel.
- If the vehicle is stationary for a long time with the engine off and the ignition on, the vehicle battery might be discharged and it might not be possible to start the engine.
- If during the STOP phase you press the **START ENGINE STOP** button, the ignition is switched off and the button flashes.
- If the indication is displayed on the instrument panel display “Start-Stop system deactivated: Start the engine manually”, the **START ENGINE STOP** button will blink.

**Starting the engine**

- Move the selector lever to the **P** or **N** position.
- Press and hold the brake pedal until the engine starts.
- Press the starter button >>> **Fig. 197**; do not press the accelerator. There needs to be a valid key inside the vehicle for the engine to start. After starting the engine, the lighting of the **START ENGINE STOP** button changes to steady lighting, indicating that the engine has started.

- Once the engine starts, release the start-up button.
- If the engine does not start, stop and wait for around 1 minute to try again. If necessary, perform an emergency start >>> page 229.

**WARNING**

Never run the engine in confined spaces, as the exhaust gases are poisonous.

- The exhaust gases contain carbon monoxide, an odourless and colourless poisonous gas. Risk of fatal accidents. Carbon monoxide can cause loss of consciousness and result in death.

**WARNING**

Do not get out of the vehicle with the engine running, especially if a gear is engaged. The vehicle could then suddenly move or something strange could happen that would cause damage, fire or serious injury.

**WARNING**

Never use cold start sprays, they could explode or cause the engine to run at high revs. Doing this risks injury.

**CAUTION**

- The starter motor or the engine may be damaged if you try to start the engine while driving or if you restart it immediately after switching it off.

- When the engine is cold, you should avoid high engine speeds, driving at full throttle and over-loading the engine. Risk of engine damage.

**For the sake of the environment**

Do not warm-up the engine by running the engine with the vehicle stationary. Start off immediately, driving gently. This helps the engine reach operating temperature faster and reduces emissions.

**Note**

- Electrical components with a high power consumption are switched off temporarily when the engine starts.
- When starting with a cold engine, noise levels may briefly increase. This is quite normal, and no cause for concern.

**Turning off the engine**

- Bring the vehicle to a full stop >>> **△**.
- Move the selector lever to the **P** position.
- Apply the electronic parking brake.
- Briefly press the start-up button >>> **Fig. 197**.



### Emergency disconnection

If the engine does not switch off after briefly pressing the starter button, an emergency disconnect will be required:

- Press the starter button twice within 3 seconds or press it once for more than 1 second >>>  in Ignition and start button on page 226.

#### WARNING

Never switch off the engine while the vehicle is moving. This could cause loss of control of the vehicle, accidents and serious injury.

- The airbags and belt tensioners do not work when the ignition is switched off.
- The brake servo does not work with the engine off. Therefore, you need to press the brake pedal harder to brake the vehicle.
- Power steering does not work when the engine is not running. You need more strength to steer when the engine is switched off.
- If the ignition is switched off, the steering column could be locked, making it impossible to control the vehicle.

#### WARNING

Always take the key with you when you leave the vehicle. This is particularly important if there are children in the vehicle, as they might otherwise be able to start the

engine or use power-operated equipment (e.g. the electric windows), which could cause injuries.

#### CAUTION

- If the vehicle is stopped and the Start-Stop system\* switches off the engine, the ignition remains switched on. Make sure that the ignition is switched off before leaving the vehicle, otherwise the battery could discharge.
- If the engine has been driven at high speed for a prolonged period of time, it may overheat when turned off. To avoid engine damage, allow the engine to run for approximately two minutes in neutral before switching it off.

#### Note

After the engine is switched off the radiator fan may run on for up to 10 minutes, even if the ignition is switched off. It is also possible that the fan turns itself on once more if the coolant temperature increases due to the heat accumulated in the engine compartment or due to its prolonged exposure to solar radiation.

### Electronic immobilizer

The electronic immobiliser prevents unauthorised persons from driving the vehicle.

Inside the key there is a chip that deactivates the electronic immobiliser automatically when the key is inserted into the ignition.

The electronic immobiliser will be activated again automatically as soon as you pull the key out of the ignition lock. For vehicles with the "Keyless Access" system, the key has to be outside the vehicle.

If the following message is shown on the instrument panel display: **SAFE**, the vehicle cannot be started.

The engine can only be started using a genuine CUPRA key with its correct code.

#### Note

A perfect operation of the vehicle is ensured if genuine CUPRA keys are used.

## Emergency starting function



**Fig. 198** On the right of the steering column: emergency start.

If no valid key is detected inside the vehicle, an emergency start-up will be required. The relevant message will appear in the dash panel display. This may happen when, for example, the vehicle key battery is very low:

- Immediately after pushing the starter button, keep the key next to the right trim of the steering column >>> **Fig. 198**, as close as possible to the Kessy logo.
- The ignition connects and the engine starts automatically.

## Instructions for the driver on the instrument panel display

**Press the brake**

This message appears on vehicles with an automatic gearbox if the driver tries to start the engine without having the brake pedal pressed.

### Select N or P

This message appears if you try to start or stop the engine when the selector lever of the automatic gearbox is not in position **P** or **N**. The engine can only be started and stopped in those positions.

### Engage position **P**; the vehicle can move; doors can only close in position **P**.

For safety reasons, this driver message appears and an audible warning sounds if the selector lever of the automatic gearbox is not in position **P** after you switch off the ignition. Move the selector lever to the **P** position, otherwise the vehicle could move.

### Gear change: selector lever in the drive position!

This driver message is displayed when the selector lever is not in the position **P** when the driver door is opened. Additionally, a buzzing sound is emitted. Put the selector lever in position **P**, otherwise the vehicle could roll away.

### Ignition is switched on

This driver message is displayed and a buzzer is sounded when the driver door is opened with the ignition switched on.

## “My Beat” function

For vehicles with a convenience key there is the “My Beat” function. This feature provides an additional indication of the vehicle ignition system.

When entering the vehicle, the start button >>> **Fig. 197** flashes to draw attention to it.

When the ignition is on/off, the engine start button flashes. With the ignition is switched off, the start button goes off after a few seconds.

With the engine running, the start button light stays on, indicating that the engine is running. The time elapsed between the moment the user starts the engine with the start button and the lighting changes from flashing to fixed will depend on specific engine size characteristics. When the start button is used to stop the engine, the button starts flashing again.

In vehicles with the **Start-Stop system**, the “My Beat” function also offers additional information:

- When the engine stops during the Stop phase, the light of the start button button >>

stays on, as the Start-Stop system remains active even though the engine is off.

- When the engine cannot be started again with the Start-Stop system, »» page 230, and needs to be started manually, the start button flashes to indicate this situation.

## Start-Stop system

### Control lamps

#### It lights up

The Start-Stop system is available, the automatic engine shutdown is active.

#### It lights up

The Start-Stop system is not available or has been disconnected.

### Instructions for the driver on the instrument panel display

#### Start-Stop system deactivated. Start the engine manually

This indication for the driver shows that the Start-Stop system **cannot** start the engine again.

#### Start-Stop system: Fault! Function not available

There is a fault in the Start-Stop system. Take the vehicle to a workshop to have the fault repaired.

### Description and operation

The Start-Stop system helps you to save fuel and reduce CO<sub>2</sub> emissions.

In Start-Stop mode, the engine will automatically switch off when the vehicle stops or is stopping. The ignition remains switched on. The engine automatically switches back on when required.

In this scenario, the light of the  button remains lit.

When the ignition is switched on, the Start-Stop function is automatically activated.

Further information about the Start-Stop system can be found on the Easy Connect system: press the  > **View** > **Vehicle status** button.

#### Stopping and starting the engine

- Brake until it is stopped, and keep your foot on the brake pedal or activate the Auto Hold\* system so that the vehicle remains braked. The engine will switch off. The warning lamp  will appear in the display. The engine can be stopped before stopping completely (approximately 7 or 2 km/h depending on the vehicle's gearbox).

- When you take your foot off the brake pedal the engine will start up again. The warning lamp will switch off. In vehicles with the Auto Hold\* system, when the system is active, the engine will not start if you remove your foot from the brake pedal. The car starts when you press the accelerator pedal.

#### Basic requirements for the Start-Stop mode

- The driver door must be closed.
- The driver's seat belt must be fastened.
- The bonnet must be closed.
- The engine has reached operating temperature.
- The reverse gear must not be engaged.
- The vehicle must not be on a very steep slope.



#### The engine does not turn off for various reasons

Before stopping the vehicle, the system verifies whether certain conditions are met. The engine **does not** switch off, in the following situations for example:

- The engine has not yet reached the required temperature for the Start-Stop mode.
- The temperature selected on the climate control has not been reached.
- The interior temperature is very high/low.



- Defrost function button activated >>> page 137.
- The parking aid\* is switched on.
- The battery is very low.
- The steering wheel is overly turned or is being turned.
- If there is a danger of misting.
- After engaging reverse gear.
- In case of a very steep gradient.

 is shown on the instrument panel display, as well as on the driver information system\*  
START  STOP.

### The engine starts by itself

When stopped, the normal system mode may be interrupted in the following situations. The engine restarts by itself without involvement from the driver.

- The interior temperature differs from the temperature selected on the climate control.
- Defrost function button activated >>> page 137.
- The brake has been pressed several times consecutively.
- The battery is too low.
- High power consumption.

### Additional information related to the automatic gearbox

The engine stops when the selector lever is in the positions **P**, **D**, **N** and **S** in addition to when in Tiptronic mode. With the selector lever in **P**, the engine will also remain switched off when you take your foot off the brake pedal. In order to start the engine up again the accelerator must be pressed, or another gear engaged or the brake released.

If the selector lever is placed in **R** while stopped, the engine will start up again.

Change from **D** to **P** to prevent the engine from accidentally starting when passing through **R**.

### Additional information about vehicles with Adaptive Cruise Control (ACC)

In vehicles with ACC function, the engine will start up again in certain operating conditions if the radar sensor detects that the vehicle ahead drives off again.

#### WARNING

- Never switch the engine off until the vehicle is stationary. The operation of the brake and steering will not be fully guaranteed. More force will be needed to turn the steering wheel or to brake. You could suffer an accident and even serious injuries.

- To avoid injury, make sure that the Start-Stop system is switched off when working in the engine compartment >>> page 232.

#### CAUTION

The Start-Stop system must always be switched off when driving through flooded areas >>> page 246.

#### Note

- You can control whether the engine should switch off or not by reducing or increasing the brake force applied. While the vehicle remains stopped, the engine will not stop if the brake pedal is slightly pressed, in traffic jams with frequent stopping and starting for example. As soon as strong pressure is applied to the brake pedal, the engine will stop.
- When stopped, the brake pedal must be kept pressed to ensure that the vehicle does not move.
- If the lever is placed in position **D**, **N** or **S** after engaging reverse gear, 10 km/h (6 mph) in a forwards direction must be reached for the system to be in a condition to stop the engine.

## Manually connecting and disconnecting the Start-Stop system



**Fig. 199** Centre console: Start-stop system button.

If you do not wish to use the system, you can switch it off manually.

- To manually switch on/off the Start-Stop system, press the  button >>> **Fig. 199**.

The button symbol  remains lit up yellow when the system is switched off.

### Note

**The system switches on every time the engine is turned off voluntarily.**

## DSG automatic transmission

### Introduction

Your vehicle is equipped with an electronically controlled manual gearbox. Torque between the engine and the gearbox is transmitted via two independent clutches. They replace the torque converter found on conventional automatic gearboxes and allow for smooth, uninterrupted acceleration of the vehicle.

The **Tiptronic** system allows the driver to change gears *manually* >>> **page 234**, Changing gear in Tiptronic mode.

### Control lamps

#### It lights up green

The brake is not pressed.  
To select a gear range, press the brake pedal.

#### Flashes green

The selector lever locking button is not engaged.  
The vehicle is prevented from moving forwards. Engage the selector lever lock.

## Selector lever positions

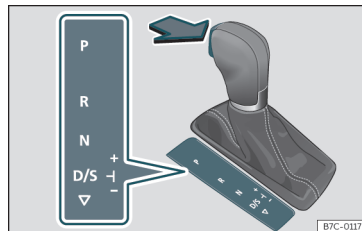

**Fig. 200** Selector lever lock.

The selector lever position is shown when the corresponding sign lights up. With the selector lever in the manual gearbox positions **M**, **D** and **S**, the engaged gear is also shown on the display.

### **P** – Parking lock

When the lever is put in this position, the drive wheels are locked. The lever must only be put in **P** when the vehicle is *stationary* >>> .

To put the lever in **P** or take it out of **P**, the locking button must be pressed and held and the brake pedal pressed simultaneously.

**R – Reverse gear**

Reverse gear must be engaged only when the vehicle is *stationary* and the engine is idling >>> .

To move the lever to position **R**, the lock button must be pressed and held while pressing the brake pedal at the same time. The reverse lights come on when the lever is in the **R** position with the ignition on.

**N – Neutral**

With the lever in this position, the gear is in neutral.

Press the brake pedal to move the lever from **N** to **D/S** when the vehicle is stationary or at speeds below 3 km/h (2 mph) >>> .

**D/S – Permanent forward drive position**

The lever in the **D/S** position enables the gears to be operated in normal mode (**D**) or sport mode (**S**). To select Sport mode **S**, move the lever backwards. Pushing the lever again will select normal mode **D**. The selected driving mode is shown on the instrument panel display.

In **normal mode (D)**, the gearbox selects the best gear ratio. This depends on the engine load, the road speed and the dynamic gear control programme (DCP).

**Sport mode (S)** should be selected for a sporty driving style. This setting makes use of

the engine's maximum power output. When accelerating the gear shifts will be noticeable.

Under certain circumstances (e.g. on mountain roads) it can be advantageous to switch tiptronic mode >>> page 234, to adapt the gears to suit the road conditions.

**Selector lever lock**

In **P** or **N**, the lever lock prevents a gear range from being engaged, and prevents the vehicle from moving off accidentally.

To release the gear lever lock, press and hold the brake pedal with the ignition on. At the same time, press the lever lock in the direction of the arrow >>> **Fig. 200**.

As a reminder to the driver, when the lever is in positions **P** or **N** the following indication will be shown on the screen:

**When stationary, apply footbrake while selecting a gear.**

The lever is not locked if it is moved quickly through position **N** (e.g. when shifting from **R** to **D**). This makes it possible, for instance, to “rock the vehicle backwards and forwards” if it is stuck in snow or mud. The lever lock engages automatically if the brake pedal is not pressed and the lever is in position **N** for more than about one second at a speed of less than 5 km/h (3 mph).

 **WARNING**

- Take care not to press the accelerator pedal when the vehicle is stopped. The vehicle could start moving immediately (in some cases even if the parking brake is engaged) resulting in the risk of an accident.
- Never move the lever to **R** or **P** when driving. Failure to follow this instruction could result in an accident or failure.
- With lever in any position (except **P**), the foot brake must be pushed down whenever the engine is running. This is because an automatic gearbox still transmits power even at idling speed.
- While you are selecting a gear and the vehicle is stopped with the engine running, do not accelerate. Failure to follow this instruction could result in an accident.
- As a driver you should never leave your vehicle if the engine is running and a gear is engaged. Switch on the electronic parking brake and select the parking lock (**P**).

 **Note**

- If the lever is moved accidentally to **N** when driving, release the accelerator and let the engine speed drop to idling before selecting gear range **D** or **S** again.
- Should the power supply to the lever be interrupted in position **P**, it will not be possible to move the lever. If this should happen the manual release can be used >>> page 238.



**Note**

- If the selector lever lock does not engage, there is a fault. The transmission is interrupted to prevent the vehicle from accidentally moving. To lock the selector lever again, press the brake pedal, place the selector lever in the P or N position and then engage a gear.
- Despite a gear being engaged, the vehicle does not move forwards or back. Proceed to the next mode:
  - When the vehicle does not move in the required direction, the system may not have the gear range correctly engaged. Press the brake pedal and engage the gear range again.
  - If the vehicle still does not move in the required direction, there is a system malfunction. Seek specialist assistance and have the system checked.

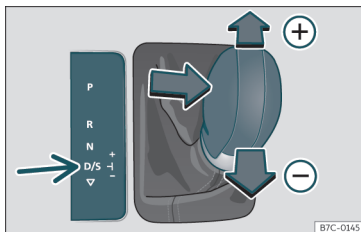
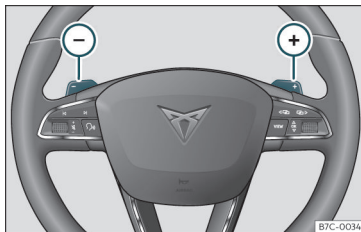
**Changing gear in Tiptronic mode****Fig. 201** Centre console: tiptronic transmission**Fig. 202** Steering wheel: automatic transmission levers

Tiptronic gives the driver the option to change gears manually.

When you change to the Tiptronic programme, the vehicle remains in the currently selected gear. This is possible as long as the

system is not changing gear automatically due to a traffic situation.

**Using Tiptronic with the selector lever**

It is possible to change to Tiptronic mode, both when the vehicle is stopped and while driving.

- Starting from the **D/S** position, move the lever to the right. The instrument panel will show whether the lever is in manual or Tiptronic mode (e.g. **M4**).
- Push the lever forwards (+) or backwards (-) to move up or down a gear >>> **Fig. 201**.
- To exit Tiptronic mode, move the lever to the left.

**Using Tiptronic with the steering wheel paddles**

The gearshift paddles can be used when the selector lever is in the **D/S** or **M** (Tiptronic) positions.

- Press the gearshift paddle (+) to select a higher gear >>> **Fig. 202**.
- Press the gearshift paddle (-) to select a lower gear.
- To exit the Tiptronic mode, pull the right-hand lever towards the steering wheel for approximately 1 second or move the lever to the left.

If the paddles are not operated for some time and the lever is not in the Tiptronic selection position, it will automatically exit from Tiptronic mode.

### ⓘ CAUTION

- When accelerating, if a higher gear is not selected, it will automatically change shortly before reaching the maximum permitted RPM.
- Also, if a lower gear is selected, the system will not change until it detects that the engine will not reach its maximum RPM.

### Driving with an automatic gearbox

The gearbox changes gear ratios automatically as the vehicle moves.

The engine can only start with the selector lever in position **P** or **N**. At low temperatures, below -10 °C (+14 °F), the engine can only start with the selector lever in position **P**.

### Driving down hills

Under certain circumstances it may be advantageous to use the Tiptronic mode to select the gear manually according to driving conditions >>> .

### Stop/Park

On level ground, just use the lever to engage position **P**. On slopes you should first apply the parking brake and then set the lever to **P**. This makes it easier to remove the lever from position **P** when starting.

If the driver door is opened and the lever is not in position **P**, the vehicle could move. The following warning is displayed on the instrument panel:  **Gear change: selector lever in the drive position!**. Additionally, a buzzer will sound.

### Stopping on a downhill

Always apply the brake pedal firmly to prevent the vehicle from moving; if necessary, apply the electronic parking brake >>> .

**Do not** accelerate while a range of gears is engaged to prevent the car from rolling downhill >>> ⓘ.

### Starting off uphill with the Auto Hold function

- Once you have engaged a gear, take your foot off the brake pedal and gently press the accelerator.

### Starting off uphill without the Auto Hold function

- Pull on the electronic parking brake button.

- Once you have engaged a gear, gently press the accelerator and pull on the electronic parking brake button.

### Back-up programme

If all the positions of the lever are shown over a light background on the instrument panel display, there is a system fault and the automatic gearbox will operate in with the back-up programme. It is still possible to drive the vehicle, however, at low speeds and within a selected range of gears. **Driving in reverse gear may not be possible.**

### Kick-down

The kick-down system provides maximum acceleration when the gear selector lever is in the positions **D**, **S** or in the Tiptronic position.

When the accelerator pedal is pressed right down, the automatic gearbox will shift down to a lower gear, depending on road speed and engine speed. This takes advantage of the maximum acceleration of the vehicle >>> .

The upshift to the next higher gear is delayed until the engine reaches maximum rpm.

### WARNING

Observe the safety warnings >>>  in Selector lever positions on page 233. »

- Never allow the brake to rub and do not use the brake pedal too often or for long periods, as the brakes can overheat. This reduces the braking power, increases the braking distance or even causes a brake system fault.
- If you have to stop on a hill, keep the vehicle's brakes applied with the brake pedal or parking brake.

### WARNING

Please note that if the road surface is slippery or wet, the kick-down feature could cause the driving wheels to spin, which could result in skidding.

### CAUTION

- If you stop the vehicle on a gradient, do not attempt to stop it from rolling by depressing the accelerator when a gear has been selected. This could cause overheating and damage the automatic gearbox.
- If you allow the vehicle to roll with the lever in position N and the engine off, the automatic gearbox will be damaged by lack of lubrication.

- In certain driving situations or traffic conditions, the gears could overheat and be damaged! If the warning lamp  lights up, stop the vehicle as soon as you can and wait for the gearbox to cool >>> page 238.
- If the gearbox operates with the backup programme, take the vehicle to a specialised workshop and have the fault repaired without delay.

### Launch-control program

The Launch-control programme enables maximum acceleration from a standstill.

*Condition:* the engine must have reached operating temperature and the steering wheel must not be turned.

The engine speed for Launch-control is different on petrol and diesel engines.

To use the Launch-control you must disconnect the anti-slip regulation (ASR) through the Easy Connect system menu >>> page 80. The warning lamp  will stay switched on or will flash slowly depending on whether or not the vehicle has a driver information system\*.

On vehicles with the driver information system, the ESC lamp lights up permanently and the corresponding text message **Stability control deactivated** (temporary) appears on the instrument panel to indicate the de-activation status.

- With the engine running, switch off traction control (ASR) >>> page 281<sup>1)</sup>.
- Press the brake pedal with your left foot and hold it down for at least one second.
- Turn the selector lever to the S or Tiptronic position, or else select the **sport** driving mode from the Drive Profile\* >>> page 241.
- With your right foot, press the accelerator down to the full throttle or kick-down position. The engine speed will stabilise at about 3,200 rpm (petrol engine) or about 2,000 rpm (diesel engine).
- Take your left foot off the brake pedal. The vehicle starts with maximum acceleration.

### WARNING

- Always adapt your driving style to the traffic conditions.
- Only use the Launch control programme when road and traffic conditions permit,

<sup>1)</sup> Vehicles without a driver information system: the warning lamp flashes slowly. Vehicles with a driver information system: the warning lamp remains on.

and make sure your manner of driving and accelerating the vehicle does not inconvenience or endanger other road users.

- Make sure that the ESC remains switched on. Please note that when the ASR and ESC are deactivated, the wheels may start to spin, causing the vehicle to lose grip. Risk of accident!
- After moving off, the ESC “sport” mode should be deactivated by briefly pressing the  OFF button.

### Note

- After using the Launch control programme, the temperature in the gearbox may have increased considerably. In this case, the programme could be disabled for several minutes. The programme can be used again after the cooling phase.
- Accelerating with the launch control programme places a heavy load on all parts of the vehicle. This can result in increased wear and tear.

### downhill assistant\*

Downhill speed control is activated when the lever is in the **D/S** position and the brake is applied. An appropriate lower gear is engaged.

The assistant attempts to maintain the speed at which the vehicle was travelling when the brake was applied, within logical limits. It may be necessary to correct the speed by pressing the brake.

The assistant can only change down as far as 3rd gear. It is possible that on very steep slopes you have to switch to tiptronic mode and change down to 2nd or 1st gear to take advantage of engine braking and take the load off the brake system.

Downhill speed control is deactivated as soon as the road levels out again or you press the accelerator pedal.

On vehicles with cruise control system\* >>> page 246, downhill speed control is activated when you set a cruising speed.

### WARNING

The downhill speed control cannot defy the laws of physics. Therefore, speed cannot be maintained constant in all situations. Always be prepared to use the brakes!

### Inertia mode

The inertia mode allows you to travel certain distances without using the accelerator, which saves fuel. Plan ahead and use the inertia mode to “let” the vehicle “roll”.

### Activation of the inertia mode

*Status:* lever in position **D**, Drive Profile engine mode setting in **ECO**, gradients of less than 12% and speeds between 20 and 130 km/h (12 and 80 mph).

- Take your foot off the accelerator.

The indication will be shown on the instrument panel , the engaged gear and current consumption will disappear and the word **Inertia** will appear.

The gears will automatically disengage and the vehicle will roll freely, without the effect of the engine brake. While the vehicle rolls, the engine runs at idling speed.

### Stopping inertia mode

- Press the brake or the accelerator pedal.

To take advantage of the engine's inertia mode, simply remove your foot from the accelerator.

Applying both the **inertia mode** (= prolonged section with less energy) and **inertia disconnection** (= shorter section without the need for fuel) facilitates improved fuel consumption and emission balance.

With **Drive Profile** >>> page 241, the inertia mode can be activated in the **Comfort** or **Individual** modes. If the engine is set to **ECO** in the **Individual** mode, it is activated when the operating conditions are met. »

**⚠ WARNING**

- If the inertia mode has been switched on, take into account, when approaching an obstacle and releasing the accelerator pedal, that the vehicle will not decelerate in the usual manner: risk of accident!
- When using inertia mode while travelling down hills, the vehicle can increase speed: risk of accident!
- If other users drive your vehicle, warn them about inertia mode.

**i Note**

- The driver message *Inertia* is only displayed with the current consumption. In inertia mode the gear will no longer be displayed (for example “D” or “E” will appear instead of “D7” or “E7”).
- The inertia mode will be automatically disconnected on gradients steeper than 15%.

**Indications on the instrument panel display****Clutch****⚠ Clutch overheating! Please stop!**

The clutch has overheated and could be damaged. Stop and wait for the gearbox to cool with the engine at idling speed and the

selector lever in position **P**. When the warning lamp and the driver message switch off, have the fault corrected by a specialised workshop without delay. If they do not turn off, do not continue driving. Seek specialist assistance.

**Faults in the gearbox****⚠ Gearbox: Fault! Stop the vehicle and place the lever in the position P.**

There is a fault in the gearbox. Stop the vehicle in a safe place and do not continue driving. Seek specialist assistance.

**⚠ Gearbox: System fault! You may continue driving.**

Have the fault corrected by a specialised workshop without delay.

**⚠ Gearbox: System fault! You can continue driving with restrictions. Reverse gear disabled**

Take the vehicle to a specialised workshop and have the fault repaired.

**⚠ Gearbox: System fault! You can continue driving in D until switching off the engine**

Park the vehicle in a safe place. Seek specialist assistance.

**⚠ Gearbox: too hot. Adapt your driving accordingly**

Continue driving at moderate speeds. When the warning lamp switches off, you can continue driving in a normal manner.

**⚠ Gearbox: press the brake and engage a gear again.**

If the warning was caused by the temperature of the gearbox, this driver message will be displayed when the gearbox has cooled again.

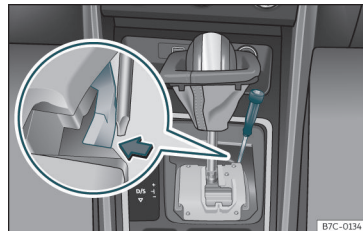
**Manual release of the selector lever**



**Fig. 203** Gear selector lever: manual release from the parking position.

In the event of a power failure when starting (e.g. discharged battery), the lever will remain locked in position **P**. To move it to position **N** to move the vehicle, there is an emergency release device under the centre console, on the right side. Releasing the selector



lever requires a certain degree of practical skill.

### Removing the cover from the selector lever

- Apply the electronic parking brake   .
- Carefully pull the corners of the selector lever boot and twist it upwards over the lever handle.

### Releasing the selector lever

- Using the flat part of a screwdriver, press the yellow tab sideways and keep it pressed down  **Fig. 203**.
- Press the lock button on the selector lever and move it to position **N**.
- After completing the emergency release, reattach the selector lever boot to the gearbox console.

#### **WARNING**

Do not move the lever from position **P** if the parking brake is not firmly engaged. If you still think the car could move, press the brake pedal. **Danger!** The vehicle could move in an unforeseen way and cause an accident or serious injury.

## Gear-change recommendation

### Selecting the optimal gear

Depending on the equipment on the instrument panel screen, a recommendation is shown with the gear that should be engaged to optimise consumption.

The lever must be in Tiptronic mode  **page 234**.

No recommendation will appear if the optimal gear is engaged. The current gear will be displayed.

Display	Meaning
<b>3</b>	Optimum gear.
<b>4 ▶ 5</b>	Changing to a higher gear is recommended.
<b>2 ▶ 1</b>	Changing to a lower gear is recommended.

### Information regarding the “cleanliness” of the particulate filter

When the exhaust system detects that the particulate filter is close to saturation, this system’s self-cleaning function recommends the optimal gear for that function  **page 316**.

#### **WARNING**

The gear change recommendation is an auxiliary function and in no case should be a substitute for careful driving.

- Responsibility for selecting the correct gear, depending on the circumstances, rests solely with the driver.

#### **For the sake of the environment**

Selecting the correct gear can help to save fuel.

#### **Note**

The indication of the recommended gear turns off when the lever is taken out of the Tiptronic position.

## Hill Descent Control (HDC)

### Control lamps



**It lights up white**

Hill Descent Control is active.



**It lights up grey**

Hill Descent Control is not active. The system is switched on, but is not adjusting. 

Some control and warning lamps will light up briefly when the ignition is switched on to check certain functions. They will switch off after a few seconds.

### WARNING

Observe the safety warnings >>>  in Control and warning lamps on page 79.

### Description and operation

Hill Descent Control limits the speed on steep descents by automatically braking all four wheels, both when moving forward and in reverse. As the anti-lock brake system remains active, it prevents the wheels from locking.

After starting the descent of a slope below 30 km/h (18 mph), speed is limited to a minimum of 2 km/h (1 mph) and a maximum of 30 km/h (18 mph). When appropriate, the driver may increase or decrease the speed within the limit by pressing the accelerator or the brake. At this point the function is interrupted and, if necessary, it is then reactivated.

Even so, it is imperative that the surface guarantees sufficient adhesion. For this reason, the Hill Descent Control **will not** fulfil its function when, for example, descending a slope with a frozen or slippery surface.

Hill Descent Control is available when the dash panel display shows the message .

Hill Descent Control automatically intervenes if the following conditions are met:

- The vehicle engine is running.
- The **Offroad** driving profile has been selected >>> page 241. Driving at a speed below 30 km/h (18 mph) (the message  is shown on the instrument panel).
- The slope of the descent is at least 10% when driving forward and 9% when driving in reverse.
- The brake and the accelerator are not pressed.

Hill Descent Control is deactivated on pressing the brake and the accelerator or if the slope is below 5%. The function may be disconnected manually in the Easy Connect system by pressing the  > **HDC** button.

### WARNING

**Always be ready to brake. Otherwise, an accident could occur and cause injury.**

- Hill Descent Control is only an auxiliary system that in some situations may not sufficiently brake the vehicle when going down a slope.
- The speed of the vehicle may increase despite the intervention of Hill Descent Control.

## Steering

### Information relating to different vehicle processes.

Electro-mechanical power steering adapts *electronically* to the speed of the car, torque and steering angle.

Even if the power steering fails or the engine is stopped, it is possible to continue to rotate the steering wheel as long as the key remains in the ignition lock, but more force must be applied.

### Progressive steering

Depending on the vehicle's features, it may or may not incorporate a progressive steering system.

In *city traffic* you do not need to turn so much on parking, manoeuvring or in very tight turns.

On the *road* or on the *motorway*, progressive steering transmits, for example, in bends, a sportier, more direct and noticeably more dynamic driving sensation.

### Steering assist

This help assists the driver in critical situations. It recommends turning the steering wheel to perform a corrective manoeuvre

(counter-steering), turning slightly to avoid skidding >>> .

### WARNING

**Steering assist helps the driver in critical situations. The driver is the person who has to control the vehicle's steering at all times.**

### Control lamp

#### It lights up red

Faulty steering.

**Do not continue driving**, stop the vehicle as soon as possible and in a safe manner.

Take the vehicle to a specialised workshop and have the fault repaired as soon as possible.

#### It lights up yellow

Limited steering operation.

Drive carefully to a specialised workshop to have the steering checked.

If the warning light does not come on again after re-starting the engine and driving a short distance, it is **not** necessary to check the steering.

**OR:** The 12-volt battery was disconnected and reconnected.

Drive a short distance at 15-20 km / h (9-12 mph).

#### It flashes yellow

The steering column is jammed.  
When stopped, turn the steering wheel in both directions.

**OR:** The steering column does not unlock or lock. Remove the key from the ignition switch and reconnect it. Consider the messages shown on the instrument panel display.

**Do not continue driving** if the steering column remains locked after switching on the ignition. Seek specialist assistance.

The control lamp should light up for a few seconds when the ignition is switched on. It should go out once the engine is started.

### WARNING

**Never ignore the warning lamps or messages.**

- **If the warning lamps and the corresponding messages are ignored, the vehicle may stall in traffic, causing serious damage or accidents and injuries.**
- **Stop the vehicle at the next opportunity and in a safe place.**

## Driving modes (Drive Profile)\*

### Introduction

The Drive Profile enables the driver to choose between six profiles or modes, **Comfort**, **Sport**, **Cupra**, **Individual**, **Offroad** and **Snow**, that modify the behaviour of various vehicle functions, providing different driving experiences.

The **Individual** profile can be configured according to personal preferences. The other profiles have a fixed configuration.

### Description

Depending on the equipment fitted in the vehicle, the Drive Profile can operate on the following functions:

#### Engine

Depending on the profile selected, the engine responds more spontaneously or more in harmony with the movements of the accelerator.

The gear change points are modified to position them in lower or higher engine speed ranges.

In addition, the function for taking advantage of inertia is activated in the **Individual** »

profile, when the engine is set to **ECO**, allowing consumption to be reduced further.

### Dynamic chassis control (DCC)

DCC continuously adapts the shock absorbers to the condition of the road and current driving conditions, according to the pre-set programme.

In the event of a fault in the DCC, the following message is displayed on the instrument screen **Fault: shock absorber regulation**

### Steering

The power steering varies its driving modes and adapts to the profile selected, thus offering the best behaviour for each situation.

### Air conditioning

In vehicles with Climatronic, this can operate in eco mode, especially restricting fuel consumption.

### Adaptive Cruise Control (ACC)

The ACC's acceleration and braking mode varies according to the driving profile >>> page 255.

### Electronic Stability Control (ESC)

In the **Offroad** and **Snow** driving profiles, the electronic stability control (ESC) >>> page 279 adjusts to adapt to the terrain.

In addition, hill descent control (HDC) is activated in the **Offroad** profile >>> page 240.

### Setting the driving profile

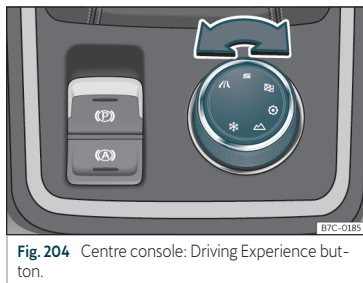

**Fig. 204** Centre console: Driving Experience button.

You can choose from the **Comfort**, **Sport**, **Cupra**, **Individual**, **Offroad** and **Snow** profiles.

The desired mode can be selected as follows:





- Turn the Driving Experience button until the required profile lights up on the Easy Connect system display as well as on the Driving Experience button >>> **Fig. 204**.



- **OR:** select the required profile on the touch-screen of the Easy Connect system, in the menu that opens up on turning the Driving Experience button.

The features of each profile can be seen by pressing the **Profile information** function button.

In the **Individual** profile it is possible to configure the characteristics of the vehicle using the **Profile setup** function button.

An icon on the Easy Connect system display informs about the active profile. The selector identifies the profile chosen by means of a red LED light.

Driving profile	Characteristics
 <b>Convenience</b>	It permits more relaxed and comfortable driving, for example for long motorway journeys. Its main characteristic is the soft suspension setting (DCC).
 <b>Sport</b>	It represents the vehicle's default behaviour, suitable for dynamic driving.
 <b>Cupra</b>	It gives the vehicle a decidedly sportier nature, and makes for maximum performance.
 <b>Individual</b>	It allows you to personalise the configuration. The functions that can be adjusted depend on the equipment fitted in the vehicle.

Driving profile	Characteristics
 <b>Offroad</b>	It adjusts the vehicle's parameters in order to maintain optimal off-road driving.
 <b>Snow</b>	It adjusts the vehicle's behaviour for driving on slippery road surfaces, optimising grip and manoeuvrability.

### **WARNING**

When operating the Drive Profile, pay attention to all traffic: doing otherwise could cause an accident.

### **Note**

- When the vehicle is switched off it will store the driving profile that was selected when the ignition key was removed. Nevertheless, when the engine is restarted, the engine and the gear will start by default in the Normal setting. For engine and gear to revert to the desired position, select the corresponding drive profile again by rotating the thumbwheel (Driving Experience Button) or selecting the profile on the Easy Connect display.
- When the vehicle is restarted after using the Offroad or Snow settings, the system is always activated in the Sport profile.

- Your speed and driving style must always be adjusted to visibility, weather, and traffic conditions.

## Driving tips

### Running in

Please observe the instructions for running in new components.

#### Running-in the engine

A new engine must be driven through a run-in period during its first 1500 kilometres (1000 miles). During its first few hours of running, the internal friction in the engine is greater than later on when all the moving parts have bedded down.

How the vehicle is driven for the first 1500 km (1000 miles) influences the future engine performance. Throughout the life of the vehicle, it should be driven at a moderate speed (especially when the engine is cold) this will reduce engine wear and increase its useful life. Never drive at extremely low engine speeds. Always engage a lower gear when the engine works "irregularly". **For the first 1000 km or 600 miles, please note:**

- Do not use full throttle.

- Do not force the engine above two thirds of its maximum speed.
- Do not tow a trailer.

**Between 1000 and 1500 kilometres (600 to 1000 miles), gradually increase power** until reaching the maximum speed and high engine speeds.

#### Running in new tyres and brake pads

- Replacement of wheel rims and new tyres >>> page 331.
- Information about brakes >>> page 275.

### **For the sake of the environment**

If the engine is run in gently, the life of the engine will be increased and the engine oil consumption reduced.

### Four-wheel drive (4Drive)

On four-wheel drive models, the engine power is distributed to all four wheels

#### General notes

On four-wheel drive vehicles, the engine power is distributed to all four wheels. The distribution of power is controlled automatically according to your driving style and the road conditions. Also see >>> page 279. »

The four-wheel drive is specially designed to complement the superior engine power. This combination gives the vehicle exceptional handling and performance capabilities, both on normal roads and in more difficult conditions, such as snow and ice. Even so (or perhaps especially for this reason), it is important to observe certain safety points >>> .

### Winter tyres

Thanks to four-wheel drive, your vehicle will have plenty of traction in winter conditions, even with the standard tyres. Nevertheless, we still recommend that winter tyres or all-season tyres be fitted on all *four* wheels to give even better *braking response*.

### Snow chains

On roads where snow chains are mandatory, this also applies to cars with four-wheel drive >>> page 336.

### Changing tyres

On vehicles with four-wheel drive, all four tyres must have the same rolling circumference. Also avoid using tyres with varying tread depths >>> page 331.

### Off-roader?

Your CUPRA vehicle is not an off-roader: it does not have enough ground clearance to

be used as such. It is therefore best to avoid rough tracks and uneven terrain as much as possible.

#### WARNING

- Even with four-wheel drive, you should always adjust your speed to suit the conditions. Do not let the extra safety features tempt you into taking any risks when driving. Risk of accident!
- The braking capability of your vehicle is limited by the tyres' grip. It is therefore no different from a car without four-wheel drive. So do not be tempted to drive too fast on firm or slippery roads just because the vehicle still has good acceleration in these conditions. Risk of accident!
- On wet roads bear in mind that the front wheels may start to "aquaplane" and lose contact with the road if the car is driven too fast. If this should happen, there will be no sudden increase in engine speed to warn the driver, as occurs with a front-wheel drive car. For this reason you should always choose a driving speed suitable for the road conditions. Risk of accident!

### Economical and environmentally friendly driving

Fuel consumption, environmental pollution and wear to the engine, brakes and tyres all depend largely on driving style. Consump-

tion can be reduced between 10-15% with an efficient driving type. The following section gives you some tips on lessening the impact on the environment and reducing your operating costs at the same time.

### Foresight when driving

If you think ahead when driving, you will need to brake less and thus accelerate less. Take advantage of the inertia of the vehicle whenever possible, with a **gear engaged**. This takes advantage of the engine braking effect, reducing wear on the brakes and tyres. Emissions and fuel consumption will drop to zero.

### Changing gear to save energy

An effective way of saving is to change *in advance* to a higher gear. Running the engine at high rpm in the lower gears uses an unnecessary amount of fuel.

- Accelerate gradually and without reaching the "kick-down" position.

### Avoid driving at high speed

Avoid travelling at your vehicle's top speed, whenever possible. Fuel consumption, emission of harmful gases and noise pollution multiply as speed is increased. Driving at moderate speeds will help to save fuel.

### Reduce idling time

In vehicles with the Start-Stop system idling is automatically reduced. In vehicles without the Start-Stop system it is worth switching off the engine, for example, at level crossings and at traffic lights that remain red for long periods of time. When an engine has reached operating temperature, and depending on the cylinder capacity, keeping it switched off for a minimum of about 5 seconds already saves more than the amount of fuel necessary for restarting.

The engine takes a long time to warm up when it is idling. Mechanical wear and pollutant emissions are also especially high during this initial warm-up phase. It is therefore best to drive off immediately after starting the engine. Avoid running the engine at high speed.

### Regular maintenance

Regular servicing helps in saving fuel even before the engine is started. A well-serviced engine gives you the benefit of **improved fuel efficiency** as well as maximum reliability and an enhanced resale value. A badly serviced engine can consume up to 10% more fuel than necessary.

### Avoid short journeys

The engine and catalytic converter need to reach their optimal **operating temperature**

in order to minimise fuel consumption and emissions.

A cold engine consumes a disproportionate amount of fuel. The engine reaches its working temperature after about four kilometres (2.5 miles), when fuel consumption will return to a normal level.

### Check tyre pressure

Always make sure the tyres are inflated to the correct pressures >>> page 333 to save fuel. If the pressure is below half bar, fuel consumption may increase by 5%. Due to the greater rolling resistance, under-inflation **also** increases tyre wear and impairs handling.

Do not use **winter tyres** all year round as they increase fuel consumption by up to 10%.

### Avoid carrying unnecessary loads

Given that every kilo of extra **weight** will increase the fuel consumption, it is advisable make sure that no unnecessary loads are being transported.

Since the luggage rack increases the **aerodynamic drag** of the vehicle, you should remove it when not needed. At speeds of 100-120 km/h (62-75 mph), this will save 12% of fuel.

### Save electrical energy

The engine drives the alternator, thereby generating electricity. This implies that any increase in power consumption also increases fuel consumption! For this reason, switch off any unneeded electrical devices. Devices that use a lot of electricity includes the blower at a high setting, the rear window heating or the seat heating\* >>> page 209.

#### Note

- If you have the Start-Stop system, it is recommended that it should not be disconnected.
- It is recommended that you close the windows when driving at more than 60 km/h (37 mph).
- Do not drive with your foot resting on the clutch pedal, as the pressure can make the plate slip. This causes wear and can damage the clutch plate.
- Do not ride the clutch on a hill, use the brake. The fuel consumption will be lower and you will prevent the clutch plate from being damaged.
- Use the engine brake on downhills by changing to the gear that is best suited for the gradient. Fuel consumption will be "zero" and the brakes will not suffer.

## Driving on flooded roads

To prevent damage to the vehicle driving on flooded roads, take the following into account:

- The water should never come above the lower edge of the bodywork.
- Drive at pedestrian speed.

### WARNING

After driving through flooded zones, braking effectiveness can decrease if the brake discs or pads are damp >>> page 275.

### CAUTION

- Driving through flooded areas may damage vehicle components such as the engine, transmission or electrical system.
- Whenever driving through water, the Start-Stop system\* must be switched off >>> page 230.

### Note

- Check the depth of the water before entering the flooded zone.
- Do not stop in the water, drive in reverse, or stop the engine.
- Vehicles travelling in the opposite direction cause waves that could exceed your vehicle's critical height.

- Avoid driving through salt water (corrosion) >>> page 343.

## Trips abroad

- With petrol vehicles, it should be ensured that lead-free petrol is available throughout the journey >>> page 314, Fuel types. Seek information about service station networks selling unleaded fuel.
- In some countries, it is possible that your vehicle is not sold and some spare parts may not be available or the technical services may only be able to make limited repairs.

CUPRA distributors and importers will provide information about the technical preparation that your vehicle requires and also about necessary maintenance and repair possibilities.

### CAUTION

CUPRA does not accept liability for any damage to the vehicle due to the use of a lower quality fuel, an inadequate service or the non-availability of genuine spare parts.

## Driver assistance systems

### Cruise control system (CCS)\*

#### Control lamp



#### It lights up green

The Cruise Control System (GRA) is switched on and active.

**OR:** The Adaptive Cruise Control system (CCS) is switched on and active.

**OR:** the speed limiter is switched on and active.

The control lamps light up when the ignition is switched on and should turn off after approximately 2 seconds. This is the time taken for the function check.



### WARNING

Observe the safety warnings >>>  in Control and warning lamps on page 79.



## Introduction

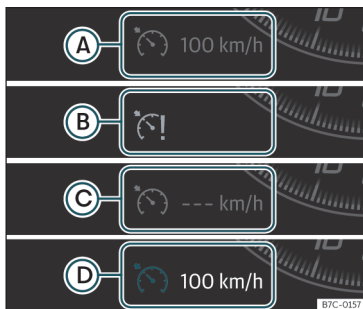

**Fig. 205** Instrument panel display: GRA status indications.

The cruise control system (CCS) is able to maintain the set speed from 20 km/h (15 mph).

The CSS only reduces vehicle speed by ceasing to accelerate, not by actively braking the vehicle >>> ⚠.

## Status display

GRA status >>> **Fig. 205**

- Ⓐ CCS temporarily switched off. The set speed is displayed in small or darkened figures.
- Ⓑ System error. Contact a specialised workshop.

- Ⓒ CCS switched on. The speed memory is empty.
- Ⓓ The CCS is switched on. The set speed is displayed in large figures.

## Changing gear in CCS mode

The CCS decelerates as soon as the clutch pedal is pressed, intervening again automatically after a gear is engaged.

## Travelling down hills with the CCS

If the CCS cannot maintain a constant vehicle speed downhill, brake and change down a gear if necessary. The GRA is temporarily disabled by pressing the brake.

## Automatic off

The GRA disconnects automatically or is temporarily interrupted:

- If the system detects a fault that could affect the working order of the CCS.
- If you press and maintain the accelerator pedal for a certain time, driving faster than the stored speed.
- If the dynamic driving control systems intervene, ASR, ESC, etc.
- If the brake pedal is pressed.
- If the airbag is triggered.
- If the lever is taken out of the **D/S** position.

## ⚠ WARNING

Use of GRA could cause accidents and severe injuries if it is not possible to drive at a constant speed maintaining the safety distance.

- Do not use GRA in heavy traffic, if the distance from the vehicle in front is insufficient, on steep roads, with several bends or in slippery circumstances or on flooded roads.
- Never use the CCS when driving off-road or on unpaved roads.
- Adapt your speed and the distance to the vehicles ahead in line with visibility, weather, the condition of the road and the traffic situation.
- To avoid unexpected operation of the cruise control system, turn it off every time you finish using it.
- It is dangerous to use a set speed which is too high for other conditions.
- If driving down a steep gradient, the GRA cannot maintain a constant speed. The speed can increase. In this case, brake and change down a gear.

## Operating the cruise control

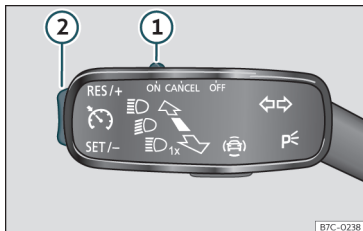

**Fig. 206** On the turn signal lever: controls for operating the GRA.

### Connecting

- Move the control >>> **Fig. 206 ①** to **ON**.

If no speed has been programmed, the system will not control it.

### Activating the cruise control

- Press button >>> **Fig. 206 ②** in area **SET/-**.

The current speed is stored and the cruise control is activated.

### Temporarily interrupting

- Move the control >>> **Fig. 206 ①** to **CANCEL** or step on the brake.

The cruise control system is switched off temporarily. The speed is stored.

### Reinstating the cruise control

- Press button >>> **Fig. 206 ②** in area **RES/+**.

Cruise control is activated at the stored speed.

### Adjusting the speed

While the GRA is set, the stored speed can be adjusted with button >>> **Fig. 206 ②**:

- To increase in increments of 1 km/h (1 mph) briefly press button >>> **Fig. 206 ②** in the area **RES/+**.
- To increase the speed without interruption, keep button >>> **Fig. 206 ②** pressed down in the area **RES/+**.
- To reduce in increments of 1 km/h (1 mph) briefly press button >>> **Fig. 206 ②** in the area **SET/-**.
- To reduce the speed without interruption, keep button >>> **Fig. 206 ②** pressed down in the area **SET/-**.

The vehicle adapts the current speed by accelerating or stopping accelerating. The vehicle does not brake actively.

### Switching off

- Move control >>> **Fig. 206 ①** to **OFF**.

The system is disconnected and the memorised speed is deleted.

## Speed limiter

### Control lamp



#### It lights up green

The speed limiter is switched on and active.



#### Flashes green

The speed set by the speed limiter has been exceeded.



#### It lights up

The adaptive cruise control (ACC) or the speed limiter is active.

The control lamps light up when the ignition is switched on and should turn off after approximately 2 seconds. This is the time taken for the function check.



### WARNING

Observe the safety warnings >>>  in Control and warning lamps on page 79.

## Introduction

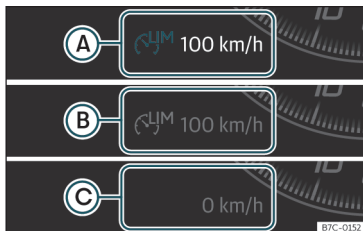

Fig. 207 On the instrument panel display: indications of the speed limited status.

The speed limiter helps avoid exceeding a programmed speed, from 30 km/h (19 mph) approx. and faster. »» » ⚠

Depending on the equipment, the speed limited can be operated using the lever of the turn signals »» » page 250 or by the third lever »» » page 251.

## Display messages on the speed limiter

Status »» » Fig. 207:

- (A) The speed limiter is active. The last speed set is displayed in large figures.
- (B) The speed limiter is not active. The last speed set is displayed in small or darkened figures.
- (C) The speed limiter is switched off. The total mileage is displayed.

## Switching between the speed limiter and GRA or ACC (while the speed limiter is connected)

To change between the driving assistance systems, press button »» » Fig. 208 (2), then select with the right thumbwheel on the multifunction steering wheel in the instrument panel menu and press the thumbwheel to confirm your selection.

It switches between the speed limiter and cruise control (GRA) or the adaptive cruise control (ACC).

## Going down slopes with the speed limiter

If the programmed speed is exceeded while driving downhill, after a short time the control warning lamp »» » page 248 flashes and an audible warning may sound. Brake and change down a gear.

## Temporarily deactivate by pressing the accelerator down

If the accelerator is pressed right down (kick-down) and the set speed is exceeded because driver wishes to do so, the limiter is temporarily disabled.

To confirm it being switched off an acoustic signal sound once. While cruise control is off, the control lamp flashes .

When the accelerator is no longer pressed down and the speed is reduced below the

set value, the limiter switches on again. The control lamp will light up and remain lit.

## Automatic off

The speed limiter is automatically switched off:

- If the system detects a fault that could negatively affect the working order of the limiter.
- If the airbag is triggered.

## ⚠ WARNING

After use, switch off the speed limiter to prevent the speed being regulated without it being required.

- The speed limiter does not relieve the driver of their responsibility to drive at the appropriate speed. Do not drive at high speed if not necessary.
- Using the speed limiter in adverse weather conditions is dangerous and can cause serious accidents. Use the speed limiter only when the condition of the road surface and the weather and traffic conditions allow it.
- When driving on a steep gradient, the speed limiter cannot limit the vehicle's speed. This can increase. In this case, brake and change down a gear. »»

**ⓘ CAUTION**

For automatic switching off due to system failures, for security reasons, the limiter is only completely switched off when the driver stops pressing the accelerator or consciously switches it off.

**ⓘ Note**

- Different versions of the instrument panel are available and therefore the versions and instructions on the display may vary.
- If the cruise control (GRA), the adaptive cruise control (ACC) or the speed limiter are connected when the ignition is switched off, the assistants will switch it when the ignition is switched on, but only the speed limiter will maintain the last programmed speed.

### Operating the speed limiter with the turn signal lever

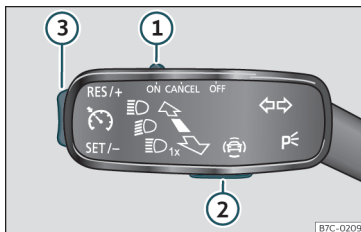

**Fig. 208** On the turn signal lever: buttons to operate the speed limiter.

#### Connecting

- Move control »» **Fig. 208 ①** to position **ON** and press button **②**.

The last programmed speed is stored. It does not take effect yet.

#### Activating the speed limiter

- While driving, press button »» **Fig. 208 ③** in the area **SET/-**.

The current speed is stored as the maximum speed.

#### Setting the programmed speed

You can set the speed using button »» **Fig. 208 ③**:

- Briefly press area **RES/+** to increase speed in small increments of 1 km/h (1 mph).
- Press and hold the area **RES/+** to continuously increase speed in increments of 10 km/h (5 mph).
- Briefly press area **SET/-** to decrease speed in small increments of 1 km/h (1 mph).
- Press and hold area **SET/-** to continuously decrease speed in increments of 10 km/h (5 mph).

The speed is limited to the set value.

#### Switching off the speed limiter

- Move control »» **Fig. 208 ①** to position **OFF**.

The system switches off.

#### Switching off temporarily

If you want to temporarily deactivate the speed limiter, e.g. for overtaking, move the control »» **Fig. 208 ①** to position **CANCEL** or press button **②**.

After overtaking, the speed limiter can be activated with the previously programmed speed by pressing button »» **Fig. 208 ③** in the area **RES/+**.

## Operating the speed limiter with the third lever

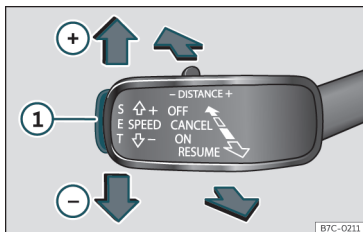

**Fig. 209** On the left of the steering column: buttons to operate the speed limiter.

### Connecting

- Move the lever towards the steering wheel to position **ON**.

The last programmed speed is stored. It does not take effect yet.

### Activating the speed limiter

- While driving, press button **SET** >>> **Fig. 209** ①.

The current speed is stored as the maximum speed.

### Setting the programmed speed

The programmed speed can be set:

- Move the lever to the pressure point **RESUME** to increase speed in small increments of 1 km/h (1 mph).
- Move the lever upwards **SPEED+** to increase in increments of 10 km/h (5 mph).
- Press the button **SET** >>> **Fig. 209** ① to reduce speed in small increments of 1 km/h (1 mph).
- Move the lever downwards **SPEED-** to reduce in increments of 10 km/h (5 mph).

To change the programmed speed without interruption, keep the lever pressed in the direction **SPEED+** (+) or **SPEED-** (-). The speed is limited to the set value.

### Switching off the speed limiter

- Move the lever to position **OFF**.

The system switches off.

### Switching off temporarily

If you want to temporarily deactivate the speed limiter, e.g. for overtaking, move the lever to the pressure point **CANCEL** or press button >>> **Fig. 209** ②.

After overtaking, the speed limiter can be activated with the previously programmed speed by moving the lever to the pressure point **RESUME**.

## Emergency brake assistance system (Front Assist)\*

### Introduction



**Fig. 210** On the instrument panel display: advance warning indications.

The objective of the system is to prevent head-on collisions against objects that may be in the vehicle's path or minimise the consequences of such impacts.

Depending on several factors and how critical the situation is, the system operates in a staggered manner. First it warns the driver, and if the driver's reaction does not occur or is insufficient, it activates independent emergency braking.

The function is intended to prevent collisions with parked vehicles or vehicles in the same lane travelling in the same direction, or with pedestrians crossing the vehicle's path or »

circulating on the same lane and in the same direction. **It may not activate in other hazard situations** >>> .

Front Assist is active between 4 km/h (2.5 mph) and 250 km/h (156 mph). Depending on a range of conditions, some of the functions described below are omitted to optimize the behaviour of the system.

**Front Assist is a driving assistance function that can never replace the driver's attention.**

#### Safety distance warning

If the system detects that you are driving too close to the vehicle in front, it will warn the driver with this indication on the instrument panel display .

The timing of the warning varies depending on driver behaviour and the traffic situation.

#### Advance warning

If the system detects a possible collision with the vehicle in front, it alerts the driver by means of an audible warning and an indication on the instrument panel display >>> **Fig. 210.**

The warning moment varies depending on the traffic situation and driver behaviour. At the same time, the vehicle will prepare for a possible emergency braking >>> .

#### Critical warning

If the driver fails to react to the **advance warning**, the system may actively intervene in the brakes and generate a brief jolt to warn the driver of the imminent danger of a collision.

#### Automatic braking

If the driver also fails to react to the **critical warning**, the system may initiate independent emergency braking by progressively increasing the braking in accordance with how critical the situation is.

#### Driver emergency brake assistance system

The system may detect that the driver is not braking hard enough to avoid the collision. In this case, it will increase the braking intensity.

The system cannot prevent a collision, although it can significantly minimise the consequences by reducing the speed and the force of the impact.

#### WARNING

Observe the safety warnings >>>  in Control and warning lamps on page 79.

#### WARNING

Front Assist cannot change the laws of physics or replace the driver in terms of

keeping control of the vehicle and reacting to a possible emergency situation.

#### WARNING

Following a Front Assist emergency warning, pay immediate attention to the situation and try to avoid the collision as applicable.

- If the Front Assist does not work as described in this chapter (e.g. it repeatedly intervenes unnecessarily), switch it off. Have the system checked by a specialised workshop. CUPRA recommends visiting a specialised CUPRA dealer or any SEAT dealership.
- Always adapt your speed and distance away from the vehicle in front of you at all times to suit visibility, weather, road and traffic conditions.
- The Front Assist alone cannot avoid accidents and serious injuries.
- In complex driving situations, Front Assist may issue warnings and intervene in braking unnecessarily.
- If the operation of the Front Assist is impaired by dirt or because the radar sensor has lost its settings, the system may issue unnecessary warnings and intervene inopportunely in the braking.
- The Front Assist does not react to animals or vehicles crossing your path or approaching head-on down the same lane.

- The Front Assist does not react to pedestrians walking head-on in the same lane.
- The driver must always be ready to take over the control of the vehicle.

#### **i** Note

- When Front Assist is connected, the indications of other functions on the screen may be hidden.
- When the Front Assist causes a braking, the brake pedal is “harder”.
- Automatic interventions by the Front Assist on the brakes may be interrupted by pressing the clutch, accelerator or moving the wheel.
- The Front Assist may brake the vehicle until it stops completely. However, the brake system does not halt the vehicle permanently. Use the foot brake!
- If the Front Assist does not work as described in this chapter (e.g. in intervenes several times unnecessarily), switch it off.

### Radar sensors

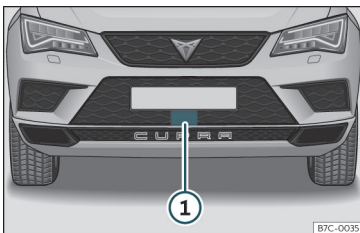

Fig. 211 On the front bumper: radar sensors.

A radar sensor is installed on the front bumper to determine the traffic situation >>> Fig. 211 ①.

The radar sensor's visibility may be impaired by dirt, or by environmental influences such as rain or mist. In this case, the Front Assist does not work. The instrument panel displays the following message: **Front Assist: No sensor vision!** Clean the radar sensor >>> ①.

When the radar sensor begins to operate properly again, the Front Assist will be available again. The message will disappear from the screen.

Front Assist operation may be affected by a strong radar reverse reflection. This may occur, for example, in a closed car park or due

to the presence of metallic objects (e.g. guard rails or sheets used in road works).

The area in front of and around the radar sensor should not be covered with adhesives, additional or similar headlights, as this may negatively affect Front Assist operation.

If the front of the vehicle is not properly repaired or structural modifications are made to it, Front Assist operation may be affected. This is why CUPRA recommends visiting a specialised CUPRA dealer or any SEAT dealership.

#### ⚠ CAUTION

If you have the feeling that the radar sensor is damaged or has lost its settings, disconnect the Front Assist. This will avoid possible dangerous situations caused by the inadequate operation of the system. If this occurs have it adjusted.

- The sensor may not be adjusted correctly if it receives an impact. This may compromise the system's efficacy or disconnect it.
- Repairs to the radar sensor require specialist knowledge and special tools. This is why CUPRA recommends visiting a specialised CUPRA dealer or any SEAT dealership.
- A registration plate or plate holder on the front that is larger than the space for the registration plate, or a registration plate that is curved or warped can cause the radar to malfunction.

»

- Clean away the snow with a brush and the ice preferably with a solvent-free de-icer spray.

### Operation of the emergency brake assistance system (Front Assist)

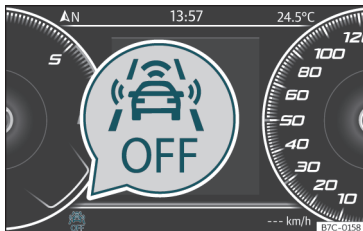

**Fig. 212** On the instrument panel display: Front Assist deactivated indication.

The Front Assist is active whenever the ignition is switched on.

When the Front Assist is switched off, so too are the **advance warning** and the **distance warning** functions.

CUPRA recommends leaving the Front Assist activated. Exceptions >>> page 254, Deactivating Front Assist temporarily in the following situations.

#### Switching the Front Assist on and off

With the ignition switched on, the Front Assist can be deactivated or activated as follows:

- Select the corresponding menu option using the button for the driver assistance systems >>> page 77.
- **OR:** by using the Easy Connect system with button  > **SETTINGS** > **Driver assistance** >>> page 80.

When the Front Assist is deactivated, the indication  >>> **Fig. 212** will be displayed on the instrument panel.

#### Activating or deactivating the pre-warning (advance warning)

The **advance warning** function can be switched on or off in the Easy Connect system with the button  > **SETTINGS** > **Driver assistance** >>> page 80.

The system will store the setting for the next time the ignition is switched on.

CUPRA recommends keeping advance warning active.

Depending on the vehicle's infotainment system the **advance warning** function may be adapted in the following modes:

- Advance
- Medium

- Delayed
- Deactivated

CUPRA recommends driving with the function in "Medium" mode.

#### Switching distance warning on and off

The distance warning can be switched on and off in the Easy Connect system using the button  > **SETTINGS** > **Driver assistance** >>> page 80.

The system will store the setting for the next time the ignition is switched on.

CUPRA recommends keeping the distance warning active.

### Deactivating Front Assist temporarily in the following situations

In the following situations the Front Assist should be deactivated due to the system's limitations:

- When the vehicle is to be towed.
- If the vehicle is on a test bed.
- When the radar sensor is damaged.
- If the radar sensor receives a violent impact.
- If it intervenes several times unnecessarily.



- If the radar sensor is temporarily covered by an accessory.
- When the vehicle is going to be loaded on- to transportation.

### System limitations

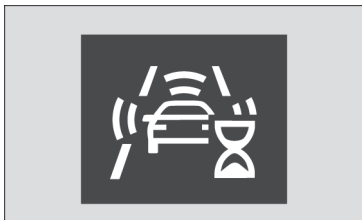

**Fig. 213** On the instrument panel display: initial system self-calibration indication.

Front Assist has certain limitations inherent to the system. Thus, in certain circumstances, some of the reactions may be inappropriate from the driver's standpoint. So pay attention in order to intervene if necessary.

**The following conditions may cause the Front Assist not to react or to do so too late:**

- In the first few instants of driving after switching on the ignition, due to the system's

initial auto-calibration. During this period, a status icon »» **Fig. 213** is displayed.

- If the Front Assist is switched off or damaged.
- If the radar sensor is dirty or covered.
- On taking tight bends or complex paths.
- Pressing the accelerator all the way down.
- If the ASR has been disconnected or the ESC activated in **Sport** mode »» page 281.
- If the ESC is controlling.
- If several brake lights of the vehicle or electrically connected trailer are damaged.
- If there are metal objects, e.g. guard rails or sheets used in road works.
- If the vehicle is reversing.
- In case of snow or heavy rain.
- In case of narrow vehicles, such as motorbikes.
- Misaligned vehicles.
- Vehicles crossing the other's path.
- Vehicles approaching in the opposite direction.
- Loads and accessories of other vehicles that protrude over the sides, backwards or over the top.

## ACC - Adaptive Cruise Control\*

### Introduction

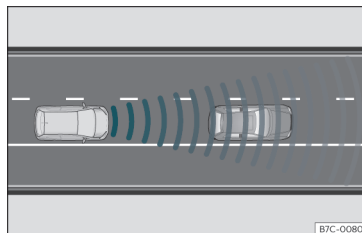

**Fig. 214** Detection area.

The ACC is an extension of the vehicle's cruise control function (GRA) »» [△](#).

It allows the driver to set a cruise speed between 30 km/h (20 mph) and 210 km/h (130 mph), and select the desired distance from the vehicle in front.

The ACC adapts the cruising speed of the vehicle, keeping a safe distance away from the vehicle in front, if there is one, depending on speed.

When driving behind another vehicle, the ACC reduces speed until it is the same as that of the vehicle ahead and maintains the »»

set distance between the vehicles. If the vehicle ahead accelerates, the ACC also accelerates the vehicle, going no higher than the programmed target speed.

If the vehicle is equipped with automatic gearbox, the ACC can brake the vehicle **until it stops completely** if a vehicle in front of it stops.

The distance programmed should be increased when the road surface is wet.

### Driver intervention prompt

ACC is subject to certain limitations inherent to the system. In other words, in certain circumstances the driver will have to adjust the speed and the distance from other vehicles.

In this case, the instrument panel screen *will warn you to intervene* by applying the brake and a warning tone will be heard  
»» page 256.

### WARNING

The ACC's technology cannot overcome the system's inherent limitations or change the laws of physics. If used negligently or involuntarily, it may cause serious accidents and injuries. The system is not a replacement for driver awareness.

- Adapt your speed and safe distance to the vehicle in front of you at all times to suit visibility, weather, road and traffic conditions.

- Do not use ACC in poor visibility, or on roads that are steep, with lots of curves or slippery.
- Never use ACC when driving off-road or on unpaved roads. The ACC has been designed for use on paved roads only.
- ACC does not react when approaching a fixed obstacle, such as the end of a traffic jam, a damaged vehicle or a vehicle stopped at the traffic lights.
- The ACC only reacts to people if a pedestrian monitoring system is available. The system does not react to animals or vehicles crossing your path or approaching head-on down the same lane.
- If the ACC does not reduce speed sufficiently, brake the vehicle immediately.
- If you are driving with a spare wheel fitted, the ACC system could automatically switch off. Switch off the system when starting off.
- If the vehicle continues to move involuntarily after a driver intervention prompt, brake the vehicle.
- If the instrument panel screen displays a *driver intervention prompt*, adjust the distance.
- The driver should be ready to accelerate or brake at all times.

### Note

- If the ACC does not work as described in this chapter, do not use it until it has been checked by a specialised workshop. This is why CUPRA recommends visiting a specialised CUPRA dealer or any SEAT dealership.
- Maximum speed with the ACC activated is limited to 210 km/h (130 mph).
- When the ACC is switched on, strange noises may be heard during braking, caused by the braking system.

### Symbols on the instrument panel display and control lamps



The speed reduction by the ACC to maintain the distance from the vehicle in front is not sufficient.

Brake! apply the foot brake! Driver intervention prompt.



ACC is not currently available<sup>a)</sup>.

While the vehicle is stationary, switch off the engine and start it again. Perform a visual check of the radar sensor »» Fig. 216. If it is still unavailable, refer to a specialised workshop to have the system inspected.

<sup>a)</sup> The symbol on the instrument panels with colour display is in colour.



The ACC is active.

No vehicle is detected in front. The programmed speed remains constant.



If the symbol is white: the ACC is active.

A vehicle in front has been detected. The ACC adjusts speed and distance from the vehicle in front.



If the symbol is grey: ACC is inactive (Standby)

The system is switched on, but is not adjusting.



The lamp lights up green

The ACC is active.

Some control and warning lamps will light up briefly when the ignition is switched on to check certain functions. They will switch off after a few seconds.

### ⚠ WARNING

Observe the safety warnings >>> ⚠ in Control and warning lamps on page 79.

### Status display

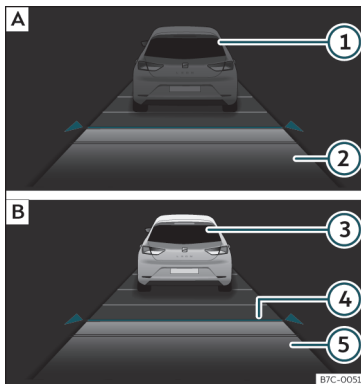

**Fig. 215** On the instrument panel display: **A** ACC inactive (Standby). **B** ACC active.

Indications on the display >>> **Fig. 215:**

- ① Vehicle ahead detected. ACC is not active and is not regulating your speed.
- ② Distance from the vehicle ahead. ACC is not active and is not regulating your distance.
- ③ Vehicle ahead detected. ACC is active and is regulating your speed.
- ④ Distance level 2 set by the driver.
- ⑤ ACC is active and is regulating your distance based on speed.

### Note

When the ACC is connected, the indications on the instrument panel screen may be concealed by warnings from other functions, such as an incoming call.

### Radar sensors

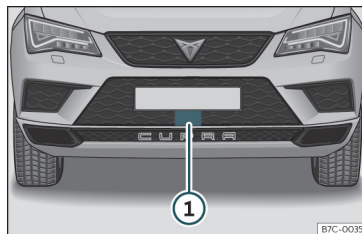

**Fig. 216** On the front bumper: radar sensors.

A radar sensor is installed on the front bumper to determine the traffic situation >>> **Fig. 216** ①.

The radar sensor's visibility may be impaired by dirt, or by environmental influences such as rain or mist. In this case the adaptive cruise control (ACC) does not work. The instrument panel displays the following message: **ACC: No sensor vision!** If necessary clean the radar sensor >>> ⚠.



When the radar sensor begins to operate properly, the ACC will become available. The message on the screen will switch off and the ACC may be reactivated.

ACC operation may be affected by a strong radar reverse reflection. This may occur, for example, in a closed car park or due to the presence of metallic objects (e.g. guard rails or sheets used in road works).

The area in front of and around the radar sensor should not be covered with adhesives, additional or similar headlights, as this may negatively affect ACC operation.

If the front of the vehicle is not properly repaired or structural modifications are made to it, ACC operation may be affected. This is why CUPRA recommends visiting a specialised CUPRA dealer or any SEAT dealership.

### ⓘ CAUTION

If you have the sensation that the radar sensor is damaged or has lost its settings, disconnect the ACC. This way you can avoid possible damage. If this occurs have it adjusted.

- The sensor may not be adjusted correctly if it receives an impact. This may compromise the system's efficacy or disconnect it.
- Repairs to the radar sensor require specialist knowledge and special tools. This is why CUPRA recommends visiting a specialised CUPRA dealer or any SEAT dealership.

- A registration plate or plate holder on the front that is larger than the space for the registration plate, or a registration plate that is curved or warped can cause the radar to malfunction.
- Clean away the snow with a brush and the ice preferably with a solvent-free de-icer spray.

### ACC operation

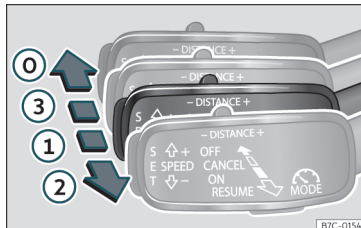

**Fig. 217** On the left of the steering column: third lever for operating the adaptive cruise control.

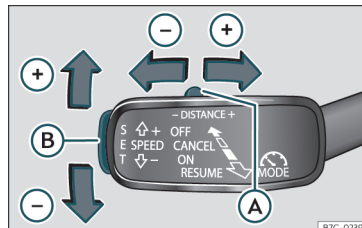

**Fig. 218** On the left of the steering column: third lever for operating the adaptive cruise control.

When the ACC is connected, the green control lamp (🟢) will light up on the instrument panel, and the programmed speed and ACC status will be displayed >>> **Fig. 215**.

### What ACC settings are possible?

- Connecting and activating the ACC >>> page 259.
- Setting your speed >>> page 259.
- Setting your distance >>> page 259.
- Disconnecting and deactivating the ACC >>> page 259.
- Adjusting the default distance level at the start of your journey >>> page 259.
- Adjusting the driving profile >>> page 259.
- Conditions in which the ACC does not react >>> page 259.

## Connecting and activating the ACC

To connect and activate the ACC, the position of the gearbox lever, the vehicle speed and the position of the third level of the ACC must all be taken into account.

- The gear lever must be in position **D** or **S**. Speed must be higher than 30 km/h (18 mph) approx.
- To activate the ACC, move the third lever to position **ON** >>> **Fig. 217 ①**. At this time, the ACC is not active and there is no programmed speed.
- Next, press button **SET** >>> **Fig. 218 ②** or move the lever to position **RESUME** >>> **Fig. 217 ②**. At this moment the ACC is activated and the current speed and distance are programmed. The picture in the box will change to Active mode >>> **Fig. 215 B**.

While ACC is active, the vehicle travels at a set speed and distance from the vehicle ahead. Both speed and distance can be changed at any time.

## Setting speed

- To set the speed, move the third lever up **+** or down **-** to the desired speed >>> **Fig. 215 ⑥**. The speed adjustment is made at 10 km/h (6 mph) intervals.
- If you wish to increase speed by intervals of 1 km/h (0.6 mph), move the lever to position

**RESUME** >>> **Fig. 217 ②**, or to decrease it press button **SET** >>> **Fig. 218 ②**.

The set speed can be changed when the vehicle is stopped or during driving.

## Setting your distance level

- To increase or reduce the distance, press button **A** to the right or left >>> **Fig. 218**.

The instrument panel display modifies the selected distance >>> **Fig. 215 ④**. There are 5 distance levels to choose from. CUPRA recommends level 3. The set distance can be changed when the vehicle is stopped or while driving >>> **A**.

## Disconnecting and deactivating the ACC

- To disconnect the ACC move the lever to position **OFF** (fixed) >>> **Fig. 217 ③**. An **ACC deactivated** message appears and the function is totally deactivated.

If you do not wish to disconnect the ACC, just to switch it temporarily to inactive mode (Standby), move the third lever to position **CANCEL** **③** or press the brake pedal.

It will also switch to inactive mode (Standby) if the vehicle is stopped and the driver door is opened.

## Adjusting the default distance level at the start of your journey

In wet road conditions, you should always set a larger distance with regard to the vehicle in front than when driving in dry conditions >>> **A**.

In the Easy Connect system, you can pre-select the distance level when connecting the ACC to: Very short, Short, Medium, Long and Very long using the button **⚙** > **SETTINGS** > **Driver assistance** >>> page 80.

## Changing the driving profile

The driving profile selected can affect ACC acceleration and braking behaviour >>> page 241.

## The following conditions may lead the ACC not to react:

- If the accelerator is pressed.
- If there is no gear engaged.
- If the ESC is controlling.
- If the driver is not wearing his/her seat belt.
- If several brake lights of the vehicle or electrically connected trailer are damaged.
- If the vehicle is reversing.
- Driving faster than 210 km/h (130 mph). »

## Driver messages

 ACC not available

• The system cannot continue to guarantee safe vehicle detection and is deactivated. The sensor has lost its setting or is damaged. Take the vehicle to a specialised workshop and have the fault repaired.

 ACC and Front Assist: currently not available. No sensor vision

• This message is displayed if the radar sensor's visibility is impaired by leaves, snow, dense fog or dirt. Clean the sensor  
»» Fig. 216.

 ACC: currently not available. Gradient too steep

• The maximum road slope has been exceeded, hence safe ACC operation cannot be guaranteed. The ACC cannot be switched on.

 ACC: only available in D, S or M

• Select the D/S or M position on the selector lever.

 ACC: parking brake applied

• The ACC is deactivated if the parking brake is applied. The ACC is available once again after the parking brake is released.

 ACC: currently not available. Intervention of stability control

• The indication is displayed when the electronic stability control (ESC) intervenes. In this case, the ACC is automatically switched off.

 ACC: Take action!

• The indication is displayed if, when the vehicle starts up on a hill with a slight slope, the vehicle rolls back even although the ACC is activated. Apply the brake to stop the vehicle from moving/colliding with another vehicle.

 ACC: engine speed

• This indication is displayed if, when the ACC accelerates or brakes, the driver does not shift up or down a gear in time, which means exceeding or not reaching the permitted RPM. The ACC switches itself off. A buzzer warning is heard.

## Door open

• The ACC cannot be activated when the vehicle is stationary and the door is open.

 WARNING

There is a danger of rear collision when the distance to the vehicle in front is reduced and the speed difference between both vehicles is so great that a speed reduction by the ACC is not sufficient. In this case, brake immediately!

• The ACC may not be able to detect all situations properly.

• Stepping on the accelerator may cause the ACC not to intervene in braking. Driver braking will have priority over intervention by the speed control or adaptive cruise control.

• Always be ready to use the brakes!

• Observe country-specific provisions governing obligatory minimum distances between vehicles.

• It is dangerous to activate control and resume the programmed speed if the road, traffic or weather conditions do not permit this. Risk of accident!

 Note

• The programmed speed is erased once the ignition or the ACC are switched off.

• When the traction control system (ASR) is deactivated during acceleration or else the ESC is activated in Sport\* Mode (»» page 80), the ACC switches off automatically.

• In vehicles with the Start-Stop system, the engine switches off during the ACC stopping phase and restarts for moving off.

## Function to prevent overtaking on the right

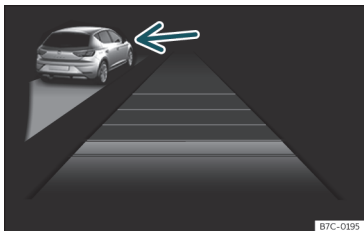

**Fig. 219** On the instrument panel display: ACC active, vehicle detected in an outer lane.

The ACC has a function to prevent overtaking on the right.

If another vehicle is driving more slowly to the left of the vehicle, it is shown on the display >>> **Fig. 219**.

The system brakes the vehicle to avoid overtaking on the right, and will avoid overtaking based on speed. The driver can interrupt the intervention of the ACC by pressing the accelerator. At low speeds the function is inactive, for greater comfort in a traffic jam or in city traffic.

## Deactivating the ACC temporarily in certain situations

In the following situations the ACC should be deactivated due to the system's limitations >>> :

- When overtaking, on closed curves or mountain roads, roundabouts, slip roads or roadwork sections, preventing the system from accelerating to reach the programmed speed.
- When going through a tunnel, as operation could be affected.
- When other vehicles are going slower in the left lane. In this case, slower vehicles will be overtaken on the right.
- In case of heavy rain, snow or fog, the vehicle in front may not be detected.

### WARNING

If the ACC does not switch off in the situations described, serious accidents and injuries may occur.

- Always switch off the ACC in critical situations.

### Note

If you do not switch off the ACC in the aforementioned situations, you may commit a legal offence.

## Special driving recommendations

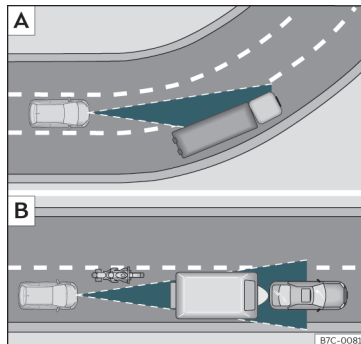

**Fig. 220** **A**) Vehicle on a bend. **B**) Motorcyclist ahead, out of range of the radar sensor.

&gt;&gt;

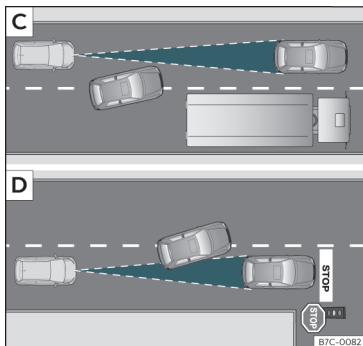

**Fig. 221** [C] Vehicle changing lanes. [D] One vehicle turning and another stationary.

The ACC has certain limitations inherent to the system. Certain reactions, under certain circumstances, may be unexpected or come late from the driver's point of view. So pay attention in order to intervene if necessary.

The following situations require maximum attention:

#### Starting driving after a stopping phase (only with automatic transmission)

After a stopping phase, the ACC may begin driving when the vehicle in front moves off >>> .

#### Overtaking

When the turn signal lights up before the vehicle starts to overtake, the ACC accelerates the vehicle automatically and thus reduces the distance from the vehicle in front.

When the vehicle moves to the overtaking lane, if the ACC does not detect another vehicle in front, it accelerates until it reaches the programmed speed.

System acceleration can be interrupted at any time by pressing the brake or moving the third lever to position **CANCEL** >>> **Fig. 217** .

#### Driving through a bend

When entering or leaving some curves, the radar sensor may cease to sense the vehicle in front of it, or react to a vehicle in the adjacent lane >>> **Fig. 220** [A]. The vehicle may brake unnecessarily or stop reacting to the vehicle in front. In this case, the driver has to intervene by accelerating or interrupting braking by applying the brake or pushing the third lever to position **CANCEL** >>> **Fig. 217** .

#### Driving in tunnels

When driving through tunnels the radar sensor may be limited. Switch off the ACC in tunnels.

#### Narrow or misaligned vehicles

The radar sensor can only detect narrow vehicles or vehicles that circulate out of alignment when they enter its range >>> **Fig. 220** [B]. In these cases, you should brake as necessary.

#### Vehicles with special loads and accessories

Special loads and accessories of other vehicles that jut out over the sides, backwards or over the top may be out of the ACC's range. CUPRA recommends disconnecting it.

#### Other vehicles changing lanes

Vehicles changing lanes a short distance away from your own can only be detected when they are within range of the sensors. As a consequence, the ACC will take longer to react >>> **Fig. 221** [C]. Brake yourself as necessary.

#### Stationary vehicles

The ACC does not detect stationary objects while driving, such as traffic tails or damaged vehicles.

If a vehicle detected by the ACC turns or moves over and there is a stationary vehicle in front of it, the ACC will not react to it >>> **Fig. 221** [D]. Brake yourself as necessary.



### Vehicles driving in the opposite direction and vehicles crossing your path

The ACC does not react to vehicles approaching from the opposite direction or vehicles crossing your path.

### Metal objects

Metal objects, e.g. guard rails or sheets used in road works, can confuse the radar sensor and cause the ACC to react wrongly.

### Factors that may affect how the radar sensor operates

If laser sensor operation is impaired, due to heavy rain snow or mud, the ACC is deactivated temporarily. A message will be displayed stating this. Clean the sensor if necessary >>> Fig. 216.

When the radar sensor begins to operate properly, the ACC will become available. The message will turn off and the ACC may be re-activated.

ACC operation may be affected by a strong radar reverse reflection, for example in a closed car park. CUPRA recommends disconnecting it.

### Trailer mode

When driving with trailer the ACC controls less dynamically.

### Overheated brakes

If the brakes overheat, for example on long and steep descents, the ACC may be deactivated temporarily. A message will be displayed stating this. In this case, adaptive cruise control cannot be activated.

Cruise control may be reactivated once the brake temperature has dropped. The message will disappear. If the message **ACC not available** remains on for quite a long time it means that there is a fault. Contact a specialised workshop. CUPRA recommends visiting a specialised CUPRA dealer or any SEAT dealership.

#### WARNING

**If you do not pay attention to the Press the brake message, the vehicle may move and crash into the vehicle ahead. Before driving off again, check that the road is clear. The radar sensor may not detect obstacles on the road. This could cause an accident and serious injuries. If necessary, apply the brake.**

## Lane Assist\*

### Introduction

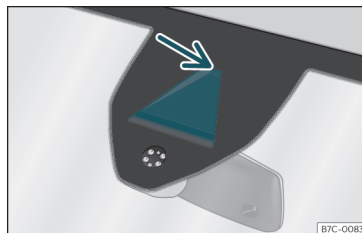

Fig. 222 On the windscreen: field of vision of the Lane Assist system.

Using the camera located in the windscreen, the Lane Assist system detects the possible lines dividing the lanes. When the vehicle involuntarily approaches a dividing line it has detected, the system notifies the driver with a *corrective steering movement*. The purpose is not only to warn the driver, but also to keep the vehicle inside the lane. This movement can be over-regulated at any time.

No warning is produced with the turn signals activated, given that the Lane Assist system understands that a lane change is required.

## Control lamp

 It lights up yellow

Lane Assist system active but not available.  
The system cannot accurately recognize the lane.  
See page 265, lane assist system not available (the control lamp is lit up in yellow)

 It lights up green

Lane Assist system active and available.

 It lights up yellow

Error in the lane departure warning system. Take the vehicle to a specialised workshop to repair the fault.

Some control and warning lamps will light up briefly when the ignition is switched on to check certain functions. They will switch off after a few seconds.

 **WARNING**

Observe the safety warnings >>>  in Control and warning lamps on page 79.

## Indications on the instrument panel display

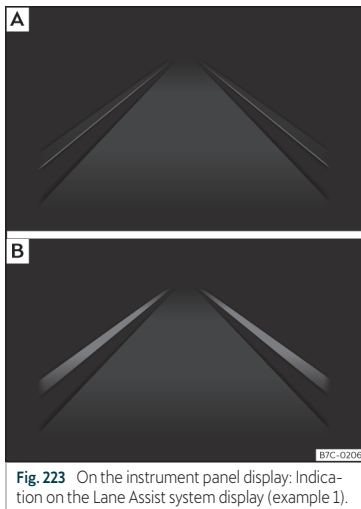

Fig. 223 On the instrument panel display: Indication on the Lane Assist system display (example 1).

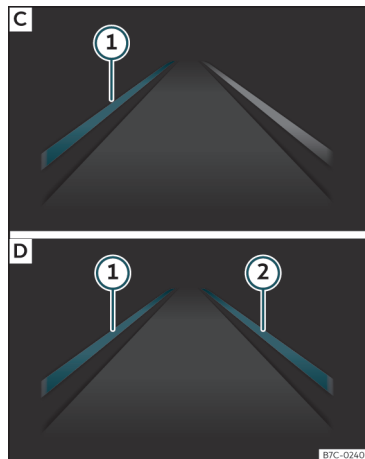

Fig. 224 On the instrument panel display: Indication on the Lane Assist system display (example 2).

## Status display

- Fig. 223 [A]: The system is active, but not available, either because the minimum speed has not been reached or because the lane lines are not recognised.
- Fig. 223 [B]: The system is active and available, both lane lines are recognised. The steering angle is not being corrected at this moment.

- **Fig. 224 C:** The system is operational, the highlighted line ① indicates that there was a risk of involuntarily crossing the lane line and that the steering is being adjusted to correct the angle.
- **Fig. 224 D:** The two highlighted lines ① and ② light up simultaneously when both lane lines are recognised and the Lane Assist function is activated.

## Operating mode

### Steering wheel vibration

The following situations can cause vibration in the steering wheel and require the driver to take active control of driving:

- When the steering angle assist value required to keep the vehicle in the lane is higher than the system's maximum operating value.
- If the system ceases to display the lane lines while assisting with steering.

### Switching the Lane Assist system on or off

- Select the corresponding menu option using the button for the driver assistance systems >>> page 77.
- **OR:** by using the Easy Connect system with button  > **SETTINGS** > **Driver assistance** >>> page 80.

### Lane Assist with lane centring guide

The **Lane Centring Guide** function is intended to keep the vehicle in the centre of the lane.

If the driver has a tendency to veer slightly off centre in the lane, the system adapts to driver preferences.

- The **Lane Centring Guide** function is activated/deactivated in the Easy Connect system using the  > **SETTINGS** >>> page 80 button.

**Automatic deactivation:** the Lane Assist system can be automatically deactivated if there is a system malfunction. The control lamp disappears.

### Hands-Off Function

In the absence of steering wheel activity the system alerts the driver with acoustic signals and a text message on the dash panel asking to actively take over the steering.

If the driver does not react to this, the system also alerts the driver with a little shaking motion through the brakes and, if the vehicle has it, activates the Emergency Assist function >>> page 268.

In vehicles without Emergency Assist, the adaptive lane guidance function will be disabled after the corresponding warnings to the driver.

**The lane assist system is active but it is not available (the control lamp is lit up yellow)**

- When driving at speeds below 65 km/h (38 mph).
- When the Lane Assist system does not detect the dividing lines of the road. For example, in the event warnings indicating road works, and snow, dirt, moisture or reflections.
- When the radius of a curve is too small.
- When no road markings can be seen.
- When the distance to the next marking to too great.
- When the system does not detect any clear and active steering movement during a long period of time.
- Temporarily, in the event of very dynamic driving styles.
- If a turn signal is activated.
- With the stability control system (ESC) in Sport mode or switched off.

### BSD Plus (Lane Assist with Blind Spot Assist)\*

The BSD Plus function is achieved by activating the Lane Assist and BSD functions >>> page 269. In this case, the Lane Assist function expands its functions in the following way:

»

If the driver tries to change lane and there is a vehicle in the blind spot:

- The  lamp flashes in the corresponding rear-view mirror even though the turn signal has not been activated.
- The steering wheel vibrates to warn the driver of the risk of collision.
- torque is applied to correct the steering and return the vehicle to its lane.

### Switching off the Lane Assist system in the following situations

Due to the limits of the Lane Assist system, switch it off in the following situations:

- When more attention is required of the driver
- When driving in a sporty style
- In unfavourable weather conditions
- On roads in poor condition
- In areas of road works

#### WARNING

The intelligent technology in the Lane Assist system cannot change the limits imposed by the laws of physics and by the very nature of the system. Careless or uncontrolled use of the Lane Assist system may cause accidents and injury. The system is not a replacement for driver awareness.

- Always adapt your speed and the distance to the vehicles ahead in line with visibility, weather conditions, the condition of the road and the traffic situation.
- Always keep your hands on the steering wheel so it can be turned at any time.
- The Lane Assist system does not detect all road markings. The road surfaces, road structures or objects in poor condition can be incorrectly detected as road markings under certain circumstances by the Lane Assist system. In such situations, switch the Lane Assist system off immediately.
- Please observe the indications on the instrument panel and act as is necessary.
- Always pay attention to the vehicle's surroundings.
- When the area of vision of the camera becomes dirty, covered or is damaged, the Lane Assist system function can be affected.

#### CAUTION

In order to avoid influencing the operation of the system, the following points must be taken into account:

- Regularly clean the area of vision of the camera and keep it in a clean state, without snow or ice >>> Fig. 222.
- Do not cover the area of vision of the camera.

- Check that the area of vision of the wind-screen camera is not damaged.

#### Note

- The lane departure warning system has been exclusively developed for driving on paved roads only.
- If the Lane Assist system does not work as described in this chapter, do not use it and contact a specialised workshop.
- If there is a fault in the system, have it checked by a specialised workshop.

## Traffic Jam Assist

### Description and operation

Traffic Jam Assist helps the driver keep the car within its lane and to move in convoy in case of traffic congestion or slow traffic.

Traffic Jam Assist is an additional function of Lane Assist >>> page 263 and combines Lane Assist functions with Adaptive Cruise Control (ACC) >>> page 255. Therefore, it is essential that you read these two chapters carefully and note the limitations of the systems and the information about them.



### Operation of Traffic Jam Assist

At speeds of below 60 km/h (40 mph), Traffic Jam Assist can maintain a (temporary) distance preset by the driver with respect to the vehicle ahead and help stay within the lane »» .

To do this, the system automatically controls the accelerator, brakes and steering, and slows the vehicle, **stopping it fully if necessary**, when faced with a vehicle in front that has stopped. It automatically moves off again when the vehicle ahead moves.

Traffic Jam Assist is designed only for use on motorways and wide roads. Therefore, never use it in city traffic.

### Technical requirements for using Traffic Jam Assist

- *Lane departure warning* must be activated: Infotainment button  > **SETTINGS** > **Driver assistance** > **Lane departure warning (Lane Assist)** function button »» page 80.
- *Adaptive lane guidance* must be activated: button  > **SETTINGS** > **Driver assistance** > **Lane Assist** button.
- Adaptive Cruise Control (ACC) must be connected and active »» page 258.
- The speed must be below 60 km/h (38 mph).

### Traffic Jam Assist is not active (the Lane Assist control light turns yellow)

- If any of the conditions mentioned on page 267, Technical requirements for using Traffic Jam Assist are no longer met.
- If any of the conditions required for operation of the Lane Assist are not met »» page 263.
- If any of the conditions necessary for the adaptive cruise control (ACC) to work are no longer fulfilled »» page 255.

### Situations where traffic jam assist has to be disconnected

Due to the limitations of the system, Traffic Jam Assist must always be switched off in the following situations:

- When more attention is required by the driver.
- When driving in a very sporty style.
- In adverse weather conditions, e.g. in case of snow or heavy rain.
- When driving on roads in poor condition.
- In sections with roadworks.
- In city journeys.

### WARNING

The smart technology incorporated into Traffic Jam Assist cannot defy the laws of physics; it only works within the limits of the

system. Accidents and severe injury may occur if Traffic Jam Assist is used negligently or involuntarily. The system is not a replacement for driver awareness.

- Adapt your speed and safe distance to the vehicle in front of you at all times to suit the visibility, weather, road and traffic conditions.
- Do not use Traffic Jam Assist in city journeys.
- Do not use Traffic Jam Assist if there is poor visibility, for example, in case of snow, ice, rain or loose gravel, or on steep or slippery sections or flooded roads.
- Do not use Traffic Jam Assist offroad or on roads where the surface is not firm. Traffic Jam Assist has been designed for use on paved roads only.
- Traffic Jam Assist does not react to people or animals or vehicles crossing your path or that approach you head-on down the same lane.
- If Traffic Jam Assist does not reduce speed sufficiently, brake the vehicle immediately by applying the pedal.
- If the vehicle continues to move when you wish it to stop after a driver intervention prompt, brake the vehicle by applying the pedal.
- If *driver intervention is requested* on the dash panel display, immediately resume control of the vehicle. »

- Keep your hands on the wheel at all times to be ready to intervene in the steering at any time. The driver is always responsible for keeping the vehicle in its own lane.
- Always be prepared to take charge of driving (accelerating or braking) yourself.

#### Note

- If Traffic Jam Assist does not work as described in this chapter, stop using it and contact a specialised workshop.
- If the system is faulty, take it to a specialised workshop and have it checked.

## Emergency Assist

### Description and operation

Emergency Assist detects whether there is inactivity by the driver and can automatically keep the car within the lane and stop it altogether if necessary. This way the system can actively help avoid an accident.

Emergency Assist is an additional function of Lane Assist >>> page 263 and combines Lane Assist functions with Adaptive Cruise Control (ACC) >>> page 255. Therefore, it is essential that you read these two chapters carefully and note the limitations of the systems and the information about them.

### Operation of Emergency Assist

Emergency Assist detects when the driver ceases to perform any activity and repeatedly requests that he/she regain active control of the vehicle, through the use of optical and acoustic warnings and by applying the brakes.

If the driver continues to do nothing, the system automatically takes over the accelerator, brakes and steering in order to brake the vehicle and keep it in its lane >>> . When the emergency assistant is actively regulating, the hazard lights turn on >>> page 112.

If the remaining braking distance is sufficient, if necessary the system slows down the vehicle **until it stops completely** and automatically switches on the electronic parking brake >>> page 276.

### Connecting and disconnecting Emergency Assist

The Emergency Assist is switched on automatically when the Lane Assist is switched on >>> page 263.

### Technical requirements for using the Emergency Assist

- The adaptive cruise control (ACC) must be switched on >>> page 255.
- The Lane Assist must be switched on >>> page 263.

- The selector lever must be in the D/S position or in the Tiptronic selector gate.
- The system must have detected a lane separation line on both sides of the vehicle >>> Fig. 224.

**The following conditions may cause the Emergency Assist not to react or to switch off automatically:**

- If the driver accelerates, brakes or moves the steering wheel.
- If any of the conditions mentioned in >>> page 268, Technical requirements for using the Emergency Assist are not fulfilled.
- If any of the conditions required for operation of the Lane Assist are not met >>> page 263.
- If any of the conditions necessary for the adaptive cruise control (ACC) to work are no longer fulfilled >>> page 255.

#### WARNING

The smart technology incorporated into the Emergency Assist cannot overcome the limits imposed by the laws of physics; it only works within the limits of the system. The driver is responsible for driving the vehicle.

- Adapt your speed and safe distance to the vehicle in front of you at all times to suit the visibility, weather, road and traffic conditions.

- Keep your hands on the wheel at all times to be ready to intervene in the steering at any time.
- The Emergency Assist alone cannot always avoid accidents or serious injuries.
- If the operation of the Emergency Assist is impaired, for example if the radar sensor of the adaptive cruise control (ACC) or the Lane Assist camera are covered or have lost their settings, the system may intervene inopportunely in braking or in steering.
- The Emergency Assist does not react to people or animal or vehicles crossing your path or which approach you head-on in the same lane.

#### WARNING

If the Emergency Assist Intervenes inopportunely, serious accidents and injuries may occur.

- If the Emergency Assist does not operate properly, switch off the Lane Assist >>> page 263. Doing so will also switch off the Emergency Assist.
- Have the system checked by a specialised workshop. To do so, CUPRA recommends going to a specialised CUPRA dealer or any SEAT dealership.

#### Note

- Automatic interventions by the Emergency Assist on the brakes may be interrupted

by pressing the accelerator or brake or by moving the wheel.

- Hazard warning lights that come on automatically can be switched off by pressing the accelerator or the brake, moving the steering wheel or pressing the hazard warning light switch.
- If this occurs, the Emergency Assist may decelerate the vehicle until it comes to a complete stop.
- When the Emergency Assist is activated, it is only available again after the ignition has been switched off and back on again.

## Using the blind spot detector (BSD) with parking assistant (RCTA)\*

### Introduction

The blind spot detector (BSD) helps to detect the traffic situation behind the vehicle.

The integrated parking assistant (RCTA) helps the driver when backing out of a parallel parking spot and in manoeuvring.

The blind spot detector has been developed for driving on paved roads.

#### WARNING

The smart technology incorporated into the blind spot detector (BSD) with parking assistance (RCTA) included cannot overcome the limits imposed by the laws of physics; it only works within the limits of the system. Accidents and severe injury may occur if the blind spot detection system or the rear cross traffic alert are used negligently or involuntarily. The system is not a replacement for driver awareness.

- Adapt your speed and safe distance to the vehicle in front of you at all times to suit visibility, weather, road and traffic conditions.
- Keep your hands on the wheel at all times to be ready to intervene in the steering at any time.
- Pay attention to the control lamps that may come on in the external rear view mirrors and on the instrument panel, and follow any instructions they may give.
- The blind spot assistant could react to any special constructions that might be present on the sides of the vehicle: e.g. high or irregular dividers. This may cause erroneous warnings.
- Never use the blind spot detector with rear cross traffic alert on unpaved roads. The blind spot detector with rear cross traffic alert has been designed for use on paved roads.

»

- Always pay attention to the vehicle's surroundings.
- Never use the blind spot detector or the parking assistant if the radar sensors are dirty.
- The external rear view mirror control lamps may have limited functionality due to solar radiation.

### ⓘ CAUTION

- The radar sensors on the rear bumper may be damaged or shifted in the event of a collision, for example, when entering or exiting a parking space. This may result in the system disconnecting itself, or at least possibly having its functionality diminished.
- In order to ensure that the radar sensors work properly, keep the rear bumper free of snow and ice and do not cover it.
- The rear bumper should only be painted with paint authorised by CUPRA. The blind spot detector's functions may be limited or work incorrectly if other paints are used.

### 📘 Note

If the blind spot detector with parking assistant does not work as described in this chapter, stop using it and contact a specialised workshop.

## Control lamps

### Control lamp in external rear view mirrors:

#### It lights up

It lights up once briefly: the blind spot detector is activated and ready to operate.

It lights up: blind spot detector has detected a vehicle in the blind spot.

#### Flashes

The blind spot detector has detected a vehicle in the blind spot and the turn signal has been turned on in the direction of the detected vehicle >>> .

For vehicles that are also equipped with Lane Assist >>> page 263, a warning to switch lanes will also appear even though the turn signal has not been engaged (blind spot detector "Plus").

The control lamps light up when the ignition is switched on and should turn off after approximately 2 seconds. This is the time taken for the function check.

If there are no indications from the control lamp in the external rear view mirror, this means that the blind spot detector has not detected any other vehicles in the area >>> .

If the dipped beam is on, then the control lamps in the external rear view mirrors will be dimmed (night mode).

### WARNING

If the warning lamps and the corresponding messages are ignored when they light up, the vehicle may stall in traffic and cause accidents and severe injuries.

- Never ignore the warning lamps or messages.
- Carry out the necessary operations.

### ⓘ CAUTION

Failure to heed the control lamps and corresponding text messages when they light up may result in damage to the vehicle.



## Blind spot detector (BSD)



**Fig. 225** In the exterior mirrors: blind spot detector indication.



**Fig. 226** Rear view of the vehicle: radar sensor zones.

The blind spot detector uses radar sensors to monitor the areas behind the vehicle >>> **Fig. 226**. The system does this by measuring the vehicle's distance from other vehicles and its speed differential. The blind spot detector will not work at speeds of less than approx. 15 km/h (9 mph). The system uses optical signals in the external rear view mirrors to notify the driver.

## Indication on the exterior mirror

The control lamp (expanded view) provides an indication in the corresponding external mirror >>> **Fig. 225** regarding the traffic situation behind the vehicle, if it is deemed to be critical. The control lamp of the left-hand external mirror indicates the traffic situation

to the left of the vehicle, and the control lamp of the right-hand external mirror indicates the traffic situation to the right of the vehicle.

In the case of retrofitted tinted windows or windows with tinted film, the indications of the external mirrors may not be seen clearly or correctly.

Keep the external mirrors clean and free of snow and ice, and do not cover them with adhesives or other similar materials.

## Radar sensors

The radar sensors are located on the left and right of the bumper and are not visible from the outside >>> **Fig. 226**. The sensors monitor both the blind spot and traffic behind the vehicle >>> **Fig. 227**, >>> **Fig. 228**. The range to the sides of the vehicle is a bit larger than the width of a lane.

The lane width is not detected individually, but is rather pre-configured in the system. Thus if you are driving in wide lanes or in between two lanes, the indications may be incorrect. Furthermore, the system can detect vehicles driving in the lane next to you (if there are any), and can also detect stationary objects such as dividers, and thus give an incorrect indication.

## Driving situations

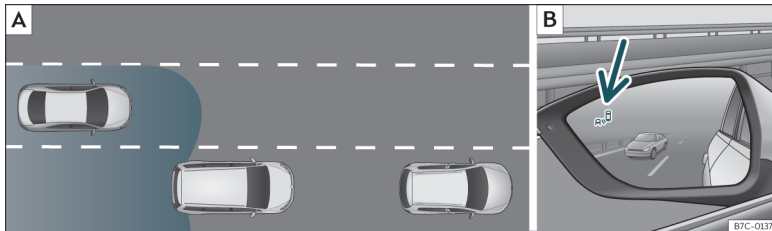

**Fig. 227** Schematic representation: **A** Passing situation with traffic behind the vehicle. **B** Indication from the blind spot detector in the left-hand external mirror.

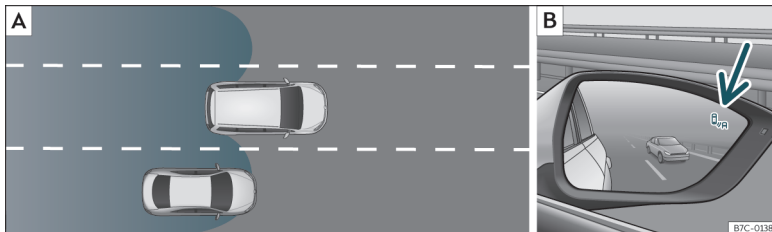

**Fig. 228** Schematic representation: **A** Situation of passing and then moving into the right-hand lane. **B** Indication from the blind spot detector in the right-hand external mirror.

In the following situations, an indication will be displayed in the external mirror  
 >>> **Fig. 227 B** (arrow) or >>> **Fig. 228 B** (arrow):

- When being overtaken by another vehicle >>> **Fig. 227 A**.
- When passing another vehicle >>> **Fig. 228 A** with a speed differential of approx. 10 km/h (6 mph). If the vehicle is passing at a

considerably higher speed, no indication will be displayed.

The faster the vehicle approaches, the sooner an indication will be displayed in the external mirror, because the blind spot detector takes into account the speed differential with other vehicles. Thus even though the distance from the other vehicle is identical, the indication will appear sooner in some cases and later in others.

### Physical limitations inherent to the system

In some situations the blind spot detector may not interpret the traffic situation correctly. E.g. in the following situations:

- on tight bends;
- in the case of lanes with different widths;
- at the top of slopes;
- in adverse weather conditions;

- in the case of special constructions to the side of the vehicle, e.g., high or irregular dividers.

### Rear cross traffic alert (RCTA)



**Fig. 229** Schematic representation of the rear cross traffic alert assistant: zone monitored around the vehicle while leaving a parking space.

The parking assistant uses the radar sensors on the rear bumper »» Fig. 226 to monitor the traffic crossing behind the vehicle as it backs out of a parallel parking space or as it is being manoeuvred, for example in very low visibility conditions.

If the system detects that someone else on the road is approaching the rear of the vehicle »» Fig. 229, an acoustic alarm is heard.

In addition to the acoustic alarm, the driver is also informed by means of a visual signal on the infotainment system display. This signal is displayed in the form of a red strip at the back of the image of the vehicle on the infotainment system screen. This strip displays the side of the vehicle towards which traffic is approaching.<sup>1)</sup>

### Automatic braking to reduce damages

If the rear cross traffic alert detects that someone else on the road is approaching the rear of the vehicle and the driver does not step on the brake, the system will engage the brakes automatically.

The parking system helps the driver by automatically engaging the brakes to reduce any damage. The automatic intervention on the brakes takes place when driving in reverse at approx. 1-12 km/h (1-7 mph). After detecting that the vehicle is stationary, the system keeps it that way for around 2 seconds.

After automatically braking to reduce damage, the system will not be able to automatically brake again for approximately 10 seconds.

You can interrupt the automatic braking by stepping hard on the accelerator pedal or the brake pedal in order to regain control of the vehicle.

### ⚠ WARNING

The smart technology incorporated into the rear cross traffic alert cannot overcome the limits imposed by the laws of physics; it only works within the limits of the system. The parking assistant function should not tempt you into taking any risks. The system is not a replacement for driver awareness.

- The system should never be used in limited visibility conditions or complicated traffic, e.g., in high-traffic areas or when crossing multiple lanes.
- Be sure to always be aware of the vehicle's surroundings, since the system often fails to detect things such as bicycles or pedestrians.
- The rear cross traffic alert itself will not brake the vehicle to a complete stop.

<sup>1)</sup> It is only displayed if the vehicle is equipped with a parking system.

## Using the blind spot detector (BSD) with parking assistant (RCTA)

### Activating and deactivating the blind spot detector (BSD) with parking assistant (RCTA)

The blind spot detector with parking assistant can be switched on and off by accessing the **Assistance systems** menu on the dash panel display using the steering wheel controls. If the vehicle is equipped with a multi-function camera, it can also be accessed by means of the driver assistance systems key located on the main beam headlight lever.

Open the **Assistants** menu.

- Blind spot
- Exit Assist

If the verification box on the control panel is checked , the functionality will be automatically activated at ignition.

When the blind spot detector is ready to operate, the indications in the external mirrors will turn on briefly as confirmation.

When the vehicle is restarted, the last adjustment in the system will remain active.

If the blind spot detector was automatically deactivated, it will only be possible to restart the system after turning the vehicle off and restarting it.

### Automatic deactivation of the blind spot detector (BSD)

The radar sensors of the blind spot detector with rear cross traffic alert will be automatically deactivated when, among other reasons, one of the sensors is detected to be permanently covered. This may be the case if, for example, there is a layer of snow or ice in front of one of the sensors.

The relevant text message will appear in the dash panel display.

### Trailer mode

The Blind spot detector and the rear cross traffic alert will be automatically deactivated and it will be impossible to activate them if the tow hitch is electrically connected to a trailer or other similar object.

As soon as the driver starts to drive with a trailer connected electrically to the vehicle, a message will appear on the instrument panel display indicating that the blind spot detector and the rear cross traffic alert are deactivated. Once the trailer has been unhitched from the vehicle, if you want to use the blind spot detector and the rear cross traffic alert, you will have to reactivate them in the corresponding menu.

If the towing hitch is not factory equipped, then the blind spot detector and the rear cross traffic alert will have to be deactivated manually when driving with a trailer.

## Braking and parking

### Braking system

#### Control lamps

##### It lights up red

Brake fluid level too low >>> page 324 or fault in the brake system.

 **Do not carry on driving!**

##### It lights up red

Electronic parking brake >>> page 276.

The warning lamp turns off when the handbrake is released.

##### It lights up green

Auto Hold function activated >>> page 278.



##### It lights up yellow

Front brake pads worn.

Contact a specialised workshop immediately.

#### WARNING

- **If the brake warning lamp  does not go out or if it lights up when driving, the brake fluid level in the reservoir is too low so there is a risk of an accident >>> page 324, Brake fluid. Stop the vehicle and do not drive on. Obtain technical assistance.**

- If the brake warning lamp lights up  together with the ABS lamp  this could be due to an ABS fault. When this function fails, the rear wheels can lock up. Under certain circumstances, the rear of the vehicle may skid, with the danger of losing control. Stop and seek technical assistance.
- If the  lamp lights up, alone or accompanied by a warning message on the instrument panel display, please go immediately to a specialised workshop to check the brake pads and to replace them if they are worn.

### Information about the brakes

#### New brake pads

For the first 200 to 300 km (100 to 200 miles), new brake pads have not yet reached their maximum braking capacity, and need to be “run in” first. However, you can compensate for the slightly reduced braking effect by applying more pressure on the brake pedal. Avoid overloading the brakes while running them in.

#### Wear

The rate of wear on the **brake pads** depends a great deal on how you drive and the conditions in which the vehicle is operated. This is a particular problem in urban traffic and short stretches, or with very sporty driving.

Depending on the speed, the braking force and the environmental conditions (e.g. temperature, air humidity, etc.) noises may be produced when braking.

#### Wet roads or road salt

In certain situations (for example, on driving through flooded areas, in severe downpours or after washing the vehicle) the braking action could be delayed if the discs and pads are damp, or frozen in winter. In this case the brakes should be “dried” by pressing the brake pedal several times.

At high speed and with the windscreen wipers activated, the brake pads will briefly touch the brake discs. This takes place, although unnoticeable to the driver, at regular intervals to improve the response time of the brakes when they are wet.

The effectiveness of the brakes can also be temporarily reduced if the vehicle is driven for some distance without using the brakes when there is a lot of salt on the road in winter. The layer of salt that accumulates on the discs and pads can be removed by gently applying the brakes a few times.

#### Corrosion

There may be a tendency for corrosion to form on the discs and dirt to build up on the brake pads if the vehicle is used infrequently or the brakes are not used very often.

If the brakes are not used frequently, or if rust has formed on the disks, it is advisable to clean off the pads and disks by braking firmly a few times at a moderately high speed .

#### Fault in the brake system

If the brake pedal travel should ever increase *suddenly*, this may mean that one of the two brake circuits has failed. Drive immediately to the nearest specialised workshop and have the fault repaired. Drive there slowly and remember that you will have to apply more pressure on the brake pedal and allow for longer stopping distances.

#### Low brake fluid level

Malfunctions can occur in the brake system if the brake fluid level is too low. The brake fluid level is monitored electronically.

#### Brake servo

The brake servo increases the pressure you apply to the brake pedal. It works only when the engine is running.

#### WARNING

Any anomaly in the brake system can increase the braking distance, with the resulting risk of an accident.

- New brake pads and discs must be run in and do not have the correct friction during the first 200 km (124 miles). This reduced 

braking capacity may be offset by pressing on the brake pedal a little harder.

- If you are driving on roads which have been salted, braking effectiveness may be decreased.
- Brakes can overheat if used excessively on slopes. Before driving down a long steep slope, it is advisable to reduce speed and change down into a lower gear or range. Therefore, using the engine brake relieves the brakes.
- Gentle continuous braking causes the brakes to overheat and the braking distance will increase. Apply and then release the brakes alternately.
- Apply the brakes heavily to clean the brake system only in a suitable traffic situation. Do not put other road users in danger: there is risk of causing an accident.
- Ensure the vehicle does not move while in neutral, when the engine is stopped. The braking distance is increased considerably when the brake servo is not active.
- If the brake is subjected to high stresses, vapour bubbles may form in the brake system's pipes. This reduces the efficiency of the brakes.
- Non-standard or damaged front spoilers could restrict the airflow to the brakes and cause them to overheat. Before purchasing accessories please read the relevant instructions.

### ⚠ CAUTION

- Never let the brakes "drag" by leaving your foot on the pedal when it is not necessary to brake. This overheats the brakes, resulting in longer stopping distances and greater wear.
- Before driving down a long, steep gradient, it is advisable to reduce speed and select a lower gear. This makes use of engine braking and relieves the brakes. If you still have to use the brakes, it is better to brake firmly at intervals than to apply the brakes continuously.

### i Note

- If the brake servo is out of action, for example when the car is being towed, you will have to press the brake pedal considerably harder than normal to make up for the lack of servo assistance.
- If you wish to equip the vehicle with accessories such as a front spoiler or wheel covers, it is important that the flow of air to the front wheels is not obstructed, otherwise the brakes can overheat.

## Electronic parking brake





**Fig. 230** In the lower part of the centre console: electronic parking brake button



The electronic parking brake replaces the handbrake.

### Applying the electronic parking brake

The electronic parking brake can be activated whenever the vehicle is at a standstill, even when the ignition is switched off. Activate it whenever you leave or park the vehicle.

- Pull and hold the  **Fig. 230** button.
- The parking brake is activated when the control light of button **Fig. 230** (arrow) is on and the red  control lamp on the instrument panel is also on.
- Release the button.

### Disconnecting the electronic parking brake

- Switch the ignition on.
- Press the button  >>> **Fig. 230**. At the same time step hard on the brake pedal or, if the engine is running, press the accelerator pedal slightly.
- The control lamp of button >>> **Fig. 230** (arrow) and the red  control lamp on the instrument panel go out.

### Automatic release of the electronic parking brake upon moving off

The electronic parking brake is automatically switched off when starting if, after the driver's door is closed and the driver's seat belt fastened, **any** of the following situations take place:

- A gear range is engaged or switched to another one and the accelerator pedal is lightly pressed.
- To facilitate certain manoeuvres there are exceptions that allow the automatic parking brake to be released without the driver's seat belt being fastened.

The parking brake can be prevented from being automatically released by continuously pulling up the  >>> **Fig. 230** switch when starting off.

The electronic parking brake is not disconnected until the  button is released. This can facilitate starting off when a heavy load is towed >>> page 303.



### Automatic activation of the electronic parking brake when exiting the vehicle incorrectly

In vehicles with automatic transmission, the electronic parking brake is activated automatically when exiting the vehicle incorrectly if:

- The selector lever is in the **D/S** or **R** position or in the Tiptronic selector gate.
- **AND:** the vehicle is stationary.
- **AND:** the driver door is open.

### Emergency brake function

Only use the emergency brake function if you are unable to stop the vehicle with the foot brake >>> .

- Pull and hold the  >>> **Fig. 230** button in this position to **forcefully** stop the vehicle. At the same time, an acoustic warning can be heard.
- To stop the braking process, release the  button or press the accelerator.

### WARNING

The improper use of the electronic parking brake can cause accidents and serious injury.

- Never use the electronic parking brake to stop the vehicle, unless it is an emergency. Braking distances can be considerably longer, since, under certain circumstances, only the rear wheels brake. Always use the foot brake.
- Never accelerate from the engine when a gear range or a gear is engaged and the engine is running. The vehicle could move, even if the electronic parking brake is activated.

### CAUTION

To prevent the vehicle from unintentionally moving when parking it, first apply the electronic parking brake and then remove your foot from the brake pedal.

### Note

- If the vehicle battery is flat, it will not be possible to disconnect the electronic parking brake. Use the jump-start >>> page 46.
- When the electronic parking brake is applied or released, noises may be heard.
- The system performs automatic and audible tests sporadically in the parked vehicle if some time elapses without the electronic parking brake being used.

## Auto Hold Function



**Fig. 231** In the lower part of the centre console: Auto Hold function button.

The control light of the  **Fig. 231** button remains on when the Auto Hold function is connected.

Once connected, the Auto Hold function assists the driver in keeping the vehicle stationary at repeated intervals or for a certain period of time with the engine running, for example, when going up a slope, when stopped at traffic lights or in heavy traffic with intermittent stops.

When connected, the Auto Hold function automatically prevents the vehicle from rolling when stationary without pressing the brake pedal.

After detecting that the vehicle is stationary and the brake pedal has been released, the

Auto Hold function holds the vehicle. The driver can lift their foot off the brake pedal.

When the driver touches the accelerator pedal or accelerates slightly to continue driving, the Auto Hold function releases the brake. The vehicle moves according to the slope of the road.

If the vehicle is stationary and one of the conditions required by the Auto Hold function is impaired, it disconnects itself and the button's control light goes out **Fig. 231**. The electronic parking brake connects automatically, if necessary, to park the vehicle safely **Fig. 231**.

### Conditions for keeping the vehicle stationary with the Auto Hold function

- The driver door must be closed.
- The driver's seat belt must be fastened.
- The engine is running.

### Switching the Auto Hold function on and off

Press button  **Fig. 231**. The control lamp on the button goes out when the Auto Hold function is switched off.

### Automatically engaging and disengaging the Auto Hold function

If the Auto Hold function was switched on with the  button before disengaging the ig-

nitiation, the function will remain on after the ignition is re-engaged.

If the Auto Hold function was not switched on, it will automatically remain off next time the ignition is engaged.

**The Auto Hold function connects automatically if the following conditions are met** (all points must be met **at the same time** **Fig. 231**):

1. The vehicle is kept **stationary** with the brake pedal on a flat surface or on a slope.
2. The engine rotates "correctly".

**The Auto Hold function is automatically turned off if the following conditions are met:**

1. If any of the conditions mentioned on **Fig. 231**, **Conditions for keeping the vehicle stationary with the Auto Hold function** are no longer met.
2. If the engine is running irregularly or an anomaly is detected.
3. If the engine is turned off or stalls.
4. If the accelerator is pressed
5. If any of the tyres has only minimal contact with the ground, e.g. in the case of axle articulation.



**⚠ WARNING**

The smart technology incorporated into the Auto Hold function cannot defy the laws of physics; it only works within the limits of the system. The greater convenience provided by the Auto Hold function should never tempt you to take any risk that may compromise safety.

- Never leave the vehicle running and with the Auto Hold function switched on.
- The Auto Hold function cannot always keep the vehicle stationary uphill or downhill or stop it sufficiently, for example, on slippery or frozen surfaces.

**i Note**

Before entering a car wash, always switch off the Auto Hold function, because if the electronic parking brake is automatically connected, it may cause damage.

## Stabilisation and brake assistance systems

### Control lamps

#### It lights up

Fault in the ESC or ABS, or disconnection caused by the system.  
The ESC works in combination with the ABS. If the ABS fails, the lamp also lights up.

#### Flashes

ESC or ASR activated.

#### It lights up

ESC in Sport mode >>> page 281.

Or: ESC manually deactivated.

#### It lights up

ABS faulty or does not work.

The control lamps light up together when the ignition is switched on and should turn off after approximately 2 seconds. This is the time taken for the function check.

### Brake assist systems

#### Electronic Stability Control (ESC)

The ESC helps to improve safety. It reduces the tendency to skid and improves the stability and roadholding of the vehicle. The ESC detects critical handling situations, such as vehicle understeer or oversteer, or wheel-spin on the driving wheels. It stabilises the vehicle by braking individual wheels or by reducing the engine torque. The warning lamp will flash on the instrument panel when the ESC is intervening .

The ESC includes the anti-lock brake system (ABS), the hydraulic brake assist (HBA), the traction control system (ASR), electronic differential lock (EDS), electronic torque control (XDS) and tractor-trailer sway mitigation\*.

ESC also helps stabilise the vehicle by changing the torque.

The ASR can be deactivated when wheel spin is desirable >>> page 281.

#### Anti-lock brake system (ABS)

ABS prevents the wheels from locking up under braking until the vehicle has reached a virtual standstill. You can continue to steer the vehicle even when the brakes are on full. Keep your foot on the brake pedal and do not pump the brakes. You will feel the brake pedal pulsate while the ABS is working. »

If the running gear or brake system is modified, the effectiveness of the ABS could be severely limited.

### Hydraulic Brake Assist (HBA)

The brake assist system can reduce the required braking distance. The braking force is automatically boosted if you press the brake pedal quickly in an emergency. You must keep pressing the brake pedal until the danger has passed.

### Traction control system (ASR)

In the event of wheelspin, the traction control system reduces the engine torque to match the amount of grip available. This helps the car to start moving, accelerate or climb a gradient.

### Electronic differential lock (EDL)

When the EDL detects wheelspin, it brakes the spinning wheel and directs the power to the other driven wheel. This function is active up to approximately 100 km/h (62 mph).

To prevent the disc brake of the braked wheel from overheating, the EDL cuts out automatically if subjected to excessive loads. The vehicle can still be driven. The EDL will switch on again automatically when the brake has cooled down.

### Tractor-trailer sway mitigation\*

If the vehicle is pulling a trailer, it will control the following: tractor-trailers tend to sway. When the swaying of the trailer is felt by the vehicle and detected by the ESC, it will automatically brake the towing vehicle within the limits of the system and mitigate the sway. Tractor-trailer sway mitigation is not available in all countries >>> page 309.

### Electronic engine torque management (XDS)

When taking a curve, the driveshaft differential allows the outer wheel to turn at a higher speed than the inner wheel. In this way, the wheel that is turning faster (outer wheel) receives less drive torque than the inner wheel. This may mean that in certain situations the torque delivered to the inner wheel is too high, causing the wheels to spin. On the other hand, the outer wheel is receiving a lower drive torque than it could transmit. This can cause a loss of grip on the drive axle, in this case the front axle, which results in understeer or "lengthening" of the trajectory.

The XDS can detect and correct this effect via the sensors and signals of the ESC.

Via the ESC, the XDS will brake the inside wheel and counter the excess driving torque of that wheel. This means that the requested trajectory is much more precise.

XDS works in combination with the ESC and is always active, even when ASR is disconnected, or when the ESC is in Sport mode or disconnected.

### Multi-collision brake

In an accident, the multi-collision brake can help the driver by braking to avoid the risk of skidding during the accident and causing other collisions.

The multi-collision brake works for front, side or rear accidents, when the airbag control unit records its activation level and the accident takes place at a speed of over 10 km/h (6 mph). The ESC automatically brakes the vehicle, as long as the accident has not damaged the ESC, the brake hydraulics or the on-board network

The following actions control automatic braking during the accident:

- When the driver presses the accelerator, the automatic braking does not take place.
- When the braking pressure through pressing the brake pedal is greater than the system's braking pressure the vehicle will brake automatically.
- Multi-collision braking will not be available if ESC is malfunctioning.

### WARNING



Driving at high speed on icy, slippery wet ground can result in loss of vehicle control and serious injury to the driver and passengers.

- The ESC, ABS, ASR, EDS and the electronic torque control system cannot exceed the limits imposed by the laws of physics. Always bear this in mind, especially on wet or slippery roads. If you notice the systems cutting in, you should reduce your speed immediately to suit the road and traffic conditions. Do not be encouraged to take risks by the presence of more safety systems. If you do, an accident may occur.
- Please remember that the accident risk always increases if you drive fast, especially in corners or on a slippery road, or if you follow too close behind the vehicle in front of you. The ESC, ABS, brake assist, EDS and the electronic torque control system cannot prevent accidents: risk of accidents!
- Accelerate with caution on slippery surfaces (for example, icy or snow-covered). Despite the control systems, the driven wheels could spin, affecting the stability of the vehicle: risk of accident!

### Note

- The ABS and ASR will only operate correctly if the four wheels have identical tyres. Any differences in the rolling radius

of the tyres can cause the system to reduce engine power when this is not desired.

- The regulating processes of the systems can make noises due to their operation.
- If the warning lamp  or  lights up, there could be a fault >>> page 77.
- Any modifications made to the vehicle (for example, to the engine, brake system, running gear or to the combination of wheels and tyres) may affect the operation of the ABS, ASR and EDS.

### Connecting and disconnecting the ESC

The ESC is switched on automatically when the engine is started, and only works when the engine is running and includes the ABS, EDS and ASR systems.

#### Disconnecting and connecting the ESC in "Sport" mode

- In "Sport" mode, the ESC can be disconnected and connected using the Easy Connect system >>> page 80. In vehicles with a driver information system\* the corresponding indication will be displayed.

When "Sport" mode is connected, the ESC interventions are limited and the ASR is completely disconnected. In addition, the  control lamp lights up on the instrument panel.

#### Disconnecting and connecting the ESC

In some versions of the model, besides the traction control system (ASR), the electronic stability programme (ESC) can also be switched off.

- The ESC can be disconnected and connected using the Easy Connect system: button  > **SETTINGS > ESC system**. In vehicles with a driver information system\*, the corresponding indication will be displayed.

When the ESC is disconnected the control warning lamp  lights up on the instrument panel.

#### ESC in "Offroad" mode

Turn the Driving Experience button to select the Offroad mode and connect it >>> page 242. The interventions of the ASR, as well as of the EDS and the ABS system adapt to irregular terrain.

In the following exceptional situations it may make sense to activate the Offroad mode to allow the wheels to spin:

- When "swinging" the vehicle to get it unstuck.
- Driving in deep snow or on loose surfaces.
- When driving on rough terrain with much of the car's weight is lifted off the wheels (axle articulation).



- Steep descents with braking on unpaved terrain.

For your safety we recommend that you turn off the Offroad mode when it is not absolutely necessary.

To **disconnect** the “Offroad” mode, select a different driving mode.

### ESC in “Snow” mode

Turn the Driving Experience button to select the “Snow” mode and connect it.

»» page 242 Traction control system (ASR) interventions adjust to the adhesion of snowy roads.

To **disconnect** the “Snow” mode, select a different driving mode.

#### WARNING

The ESC Sport mode should be activated only when traffic conditions and the ability of the driver allow it. Danger of skidding!

- With ESC in Sport mode, the stabilising function will be limited to allow for a sportier drive. The driving wheels could spin and the vehicle could skid.
- If the ESC is deactivated, the vehicle stabilisation function is not available.

#### WARNING

You should only activate the Offroad Mode or disable the ASR if the experience of the

driver and traffic conditions allow it. Danger of skidding!

- With the Offroad mode activated, the stabilisation function is limited. In particular, if the road is too smooth and slippery, the driving wheels could spin and the vehicle could skid.

#### Note

- If the ESC Sport mode is selected, cruise control\* will be switched off.
- In ESC OFF mode, the ESC will be temporarily reactivated to assist the driver during braking and will then switch back to passive mode when the brake pedal is released (depending on the model version).

## Parking

### To park the vehicle

When parking your vehicle, all legal requirements should be observed.

Always note the following points when parking the vehicle:

- Park the vehicle on a suitable surface »» .
- Connect the electronic parking brake »» page 276.

- For an automatic gearbox, move the selector lever to position P.

• Switch the engine off and remove the key from the ignition. Turn the steering wheel slightly to engage the steering lock.

• With a manual gearbox, engage first gear on flat ground and slopes, or even reverse gear on hills, and release the clutch pedal.

- When leaving the vehicle, take all keys with you.

### Additionally, on steep slopes and inclines

Before switching off the engine, rotate the steering wheel so that if the vehicle should move, it will be held by the kerb.

- On slopes, turn the front wheels so that they are against the edge of the kerb.
- Uphill, turn the wheels towards the centre of the road.

#### WARNING

- Avoid parking the vehicle where the hot exhaust system could ignite inflammable materials, such as dry grass, low bushes, spilt fuel or flammable materials.
- Do not leave passengers inside a closed vehicle, they may not be able to open doors or windows. Locked doors hinder the possibility of a rescue.
- Children should not be left alone in the vehicle. They could tamper with the

handbrake or the gears, which could cause the vehicle to move without control.

- Depending on weather conditions, it may become extremely hot or cold inside the vehicle. This can be fatal.

### Note

In vehicles with automatic transmission, the key can only be removed from the ignition when the lever is in position P.

## Help with parking and manoeuvring

### Assisted parking system (Park Assist)\*

#### Introduction

The Park Assist system is an additional ParkPilot function »» page 290 and helps the driver to:

- find a suitable parking space,
- select a parking mode,
- park driving in reverse in suitable perpendicular and parallel spaces,
- park driving forwards in suitable perpendicular spaces,
- exit a parking space driving forwards from a parallel space.

In vehicles with a Park Assist system and factory infotainment system, the front, rear and side areas are represented, and the position of obstacles is shown relative to the vehicle.

The Park Assist system is subject to certain limitations inherent to the system and its use requires special attention by the driver »» .

### WARNING

The technology used in the park assist system involves a series of limitations inherent in the actual system and in the use of ultrasonic sensors. The use of Park Assist should never tempt you to take any risk that may compromise safety. The system is not a replacement for driver awareness.

- Any accidental movement of the vehicle could result in serious injury.
- Adapt your speed and driving style at all times to suit visibility, weather, road and traffic conditions.
- Certain surfaces of objects and garments do not reflect the ultrasound sensors' signals. The system cannot detect, at least correctly, these objects or people wearing such clothes.
- Ultrasound sensor signals may be affected by external sound sources. In certain circumstances this may prevent them from detecting people or objects.
- The ultrasound sensors have blind spots in which obstacles and people are not registered.
- Monitor the area around the vehicle at all times, since the ultrasound sensors do not detect small children, animals or certain objects in all situations. »»

**⚠ WARNING**

Quick turns of the steering wheel when parking or exiting a parking space with Park Assist can cause serious injury.

- Do not hold the steering wheel during manoeuvres to park or exit a parking space until the system requests it. Doing so disables the system during the manoeuvre, resulting in the parking being cancelled.

**ⓘ CAUTION**

• In certain circumstances, the ultrasonic sensors do not detect objects such as trailer tongues, bars, fences, posts or thin trees, or an open (or opening) rear lid, which could damage the vehicle.

• Retrofitting of certain accessories to the vehicle, such as a bicycle rack, may interfere with the operation of the Park Assist system and cause damage.

• The Park Assist system uses as a reference parked vehicles, curbs and other objects. Make sure that the tyres and wheels are not damaged while parking. If necessary, opportunely interrupt the parking manoeuvre to avoid damaging the vehicle.

• The ultrasound sensors on the bumper may be damaged or shifted in the event of a collision, for example, when entering or exiting a parking space.

• If you use high-pressure or vapour equipment to clean the ultrasound sensors, do

not apply it directly unless very briefly and always from a distance of more than 10 cm.

• A registration plate or plate holder on the front with larger than the space for the registration plate, or a registration plate that is curved or warped can cause:

- false detections,
- loss of sensor visibility.
- cancellation of the parking manoeuvre or defective parking.

• If one of the ultrasonic sensors is damaged, the area corresponding to that group of sensors (front or rear) is deactivated and cannot be activated until the fault is corrected. However, you can still use the sensors of the other bumper as per usual. If there is a fault in the system, consult a specialist workshop. To do so, CUPRA recommends going to a specialised CUPRA dealer or any SEAT dealership.

**ⓘ Note**

• In order to guarantee good system operation, keep the ultrasound sensors of the bumper clean, free of snow or ice, and do not cover them with adhesives or other objects.

• Certain sources of noise, such as rough asphalt or paving stones and the noise of other vehicles can induce the Park Assist system or ParkPilot to give erroneous warnings.

- To become familiar with the system and its functions, CUPRA recommends that you practice operating the Park Assist system in an area where there is not too much traffic or in a car park.

**Description of the parking assist system**

**Fig. 232** In the upper part of the centre console: button to switch on the Park Assist system.

The components of the Park Assist system are the ultrasonic sensors located in the front and rear bumpers, the **P** button >>> **Fig. 232** to switch the system on and off and the messages on the instrument panel display.

**Prerequisites for parking**

- The traction control system (ASR) must be turned on >>> page 281.

- Speed when passing next to the parking space (parallel parking): do not exceed approx. **40 km/h (25 mph)**.
- Speed when passing next to the parking space (angle parking): do not exceed approx. **20 km/h (12 mph)**.
- Keep a distance between **0.5 and 2.0 metres** when driving past the parking space.
- Space length (parallel parking): **vehicle length + 0.8 meters**.
- Space width (angle parking): **vehicle width + 0.8 meters**.
- Do not exceed approximately **7 km/h (4 mph)** when parking.

### Requirements for leaving the parking space (only for parallel parking)

- The traction control system (ASR) must be turned on >>> page 281.
- Space length: **length of the vehicle + 0.5 metres**.
- Do not exceed approximately **7 km/h (4 mph)** when exiting the parking space.

### Prematurely stopping or automatically interrupting the manoeuvres for parking or exiting a parking space

Park Assist interrupts the manoeuvres for parking or exiting a parking space in any of the following cases:

- Press the **P** button.
- The speed exceeds approximately 7 km/h (4 mph).
- The driver takes hold of the steering wheel.
- The parking manoeuvre does not end within 6 minutes from the activation of automatic steering.
- There is a fault in the system (the system is temporarily unavailable).
- ASR is switched off.
- ASR or ESC intervene with regulation.
- The driver door is opened.

To restart the manoeuvre it is necessary that none of these things occur and that the **P** button is pressed again.

### Special characteristics

The Park Assist system is subject to certain limitations inherent to the system. For example, it is therefore not possible to enter or exit a parking space on sharp bends.

While entering or exiting a parking space, a brief signal sounds to prompt the driver to change between forward and reverse gears (depending on the case). In successive manoeuvres, the assistant tells the driver to change gears, at the latest, when the continuous audible signal is given (object present at a distance of  $\leq 30$  cm) by Park Pilot.

When the Park Assist system turns the steering wheel with the vehicle stationary, the instrument panel also displays the symbol . Keep the brake pedal depressed while the symbol remains on the dash panel display to turn the wheels with the vehicle stopped. This way, the system will require fewer manoeuvres to complete the parking action.

### Trailer mode

The Park Assist system cannot be switched on if the factory-fitted towing bracket >>> page 303 is electrically connected to a trailer.

### After changing a wheel

If, after changing a wheel, the vehicle stops entering and exiting parking spaces correctly, the circumference of the new wheel may be different and the system may need to adapt to it. The adaptation is automatic and takes place during driving. Making turns slowly and in both directions (20 km/h [12 mph]) for a few minutes may contribute to this adaptation process >>>  in Introduction on page 283.

## Selecting a parking mode

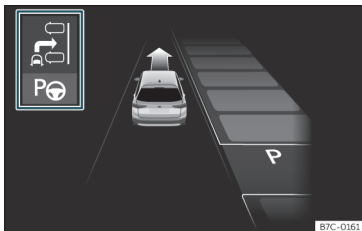

**Fig. 233** On the instrument panel display: view of the parking assist system with reduced view.

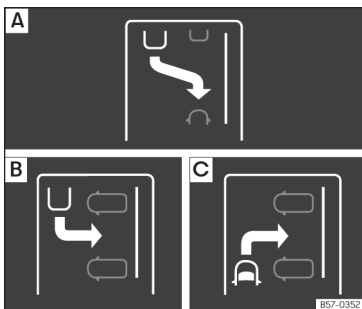

**Fig. 234** On the instrument panel display: indication of parking modes.

Parking assist has the following 3 parking modes:

- A** Reverse parallel parking.
- B** Reverse angle parking.
- C** Forward angle parking.

### Selecting a parking mode after passing in front of the space

After activating the Park Assist system and after detecting a parking space, the display on the instrument panel proposes a parking mode. The Park Assist system selects the parking mode automatically. The selected mode is shown on the instrument panel display »» Fig. 233. The reduced display of other possible parking modes is also shown »» Fig. 234. If the mode selected by the system does not correspond to the desired mode, you can select another mode by pressing the **P** button »» Fig. 232.

- The necessary conditions to park with Park Assist have to be met »» page 284.
- Press the **P** button.
- A control lamp on the **P** button lights up when the system is switched on. Additionally, the selected parking mode is shown on the instrument panel display and the reduced display shows another parking mode it can be changed to.
- Turn on the corresponding turn signal towards the side of the road where you are parking. The instrument panel displays the side corresponding to the road. By default, if

the turn signal is not on, it parks on the right in the direction of traffic.

- If necessary, press the **P** button again to change to the next parking mode.
- Once you have switched to all possible parking modes, if the **P** button is pressed again, the system switches off.
- Press the **P** button again to switch the system back on.
- Follow the instructions displayed on the instrument panel while paying attention to traffic and drive the vehicle past the parking space.

### Special case of perpendicular parking space to park forwards without driving past first

- The necessary conditions to park with Park Assist have to be met »» page 284.
- Drive forward towards the parking space while paying attention to traffic and stop the vehicle.
- Press the **P** button *once*.
- A control lamp on the **P** button lights up when the system is switched on. Additionally, the selected parking mode is shown on the instrument panel display without reduced display.
- Release the steering wheel »»  in Introduction on page 284.



## Parking with the parking assist system

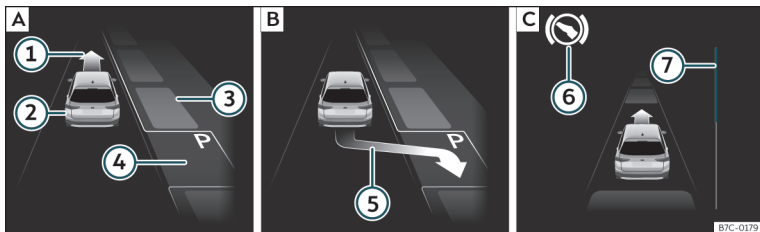

**Fig. 235** On the instrument panel display: parallel parking. **A** Finding a parking space. **B** Parking position. **C** Manoeuvring.

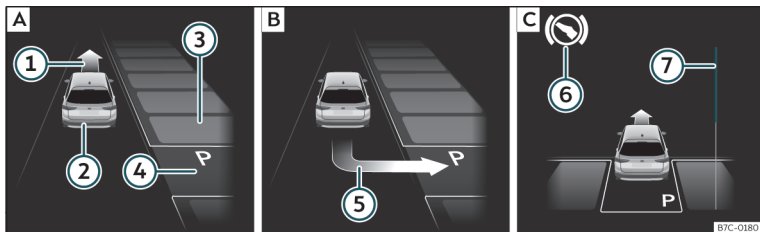

**Fig. 236** On the instrument panel display: angle parking. **A** Finding a parking space. **B** Parking position. **C** Manoeuvring.

- ① Message to move forwards
- ② Your vehicle
- ③ Parked vehicle
- ④ Parking space detected
- ⑤ Message to park
- ⑥ Message to press the brake pedal
- ⑦ Progress bar

The necessary conditions have to be met to park with Park Assist >>> page 284 and the parking mode must be selected >>> page 286.

**Parking**

- Look at the display on the instrument panel to see if the space has been detected as “appropriate” and if the correct position for parking has been reached >>> **Fig. 235 B**

or >>> **Fig. 236 B**. The space is considered “appropriate” if the display on the instrument panel shows the message to park ⑤.

- Stop the vehicle and, after a brief pause, engage the reverse gear.
- Release the steering wheel >>> **△** in Introduction on page 284. »

- Please note the following message: **Automatic steering enabled. Pay attention to your surroundings.** While you keep watch around you, carefully start accelerating up to no more than 7 km/h (4 mph). During the parking manoeuvre, the system only takes charge of the steering. **You, as the driver, have to accelerate, engage the clutch if necessary, change gears and brake.**

- Reverse until the continuous ParkPilot signal sounds; **OR:** reverse until the indication to move forward appears on the instrument panel display >>> Fig. 235 [C] or >>> Fig. 236 [C]; **OR:** reverse until the **Park Assist finished** message appears on the instrument panel display. The progress bar ⑦ indicates the distance to cover >>> page 288.

- Press the brake pedal until the parking assist system completes the steering wheel turns; **OR:** until the symbol (S) goes out on the instrument panel screen.

- Select first gear.

- Move forward until the continuous ParkPilot signal sounds; **OR:** move forward until the reverse indication appears on the instrument panel display. The Park Assist system steers the vehicle forward and back until it centres it in the space >>> Fig. 235 [C] or >>> Fig. 236 [C].

- For best results, wait at the end of each manoeuvre until the Park Assist system has finished turning the steering wheel. The parking manoeuvre ends when a corre-

sponding message is displayed on the instrument panel and, in some cases, an acoustic signal sounds.

### Progress bars

The progress bar

>>> Fig. 235 ⑦ and >>> Fig. 236 ⑦ on the screen of the instrument panel displays the relative distance to be covered. The greater the distance, the fuller the progress bar. When driving forward, the content of the progress bar decreases upwards, and when reversing, it decreases downwards.

#### Note

**If the manoeuvre is terminated prematurely during parking, the result may not be the best.**

## Leaving a parking space with the parking assist system (only for parallel parking)

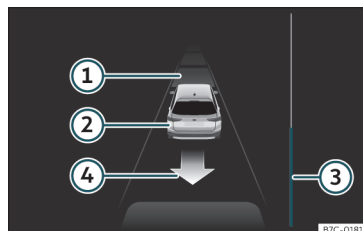



**Fig. 237** On the instrument panel display: exit a parallel parking space.

- ① Parked vehicle
- ② Your vehicle in reverse gear
- ③ Progress bar to indicate the distance left to cover
- ④ Message giving the proposed manoeuvre to exit the parking space

### Leaving a parking space (parallel parking)

The necessary conditions to exit a parking space with Park Assist have to be met >>> page 285.

- Press the **P@** button >>> Fig. 232. A control lamp on the **P@** button lights up when the system is switched on.

- Turn on the corresponding turn signal towards the road you will enter when exiting the parking space.
- Select reverse gear.
- Release the steering wheel >>>  in Introduction on page 284. Please note the following message: **Automatic steering enabled. Pay attention to your surroundings.** While you keep watch around you, carefully start accelerating up to no more than 7 km/h (4 mph). When exiting the parking space, the system **only** takes charge of the steering. **You, as the driver, have to accelerate, engage the clutch if necessary, change gears and brake.**
- Reverse until the continuous ParkPilot signal sounds; **OR:** reverse until the instrument panel display shows the forward indication. The progress bar >>> **Fig. 237**  indicates the distance to cover >>> page 288.
- Press the brake pedal until the parking assist system completes the steering wheel turns; **OR:** press the brake pedal until the symbol  goes out on the instrument panel screen.
- Move forward until the continuous ParkPilot signal sounds; **OR:** move forward until the reverse indication appears on the instrument panel display. The Park Assist system steers the vehicle forward and back until it can exit the space.

- The vehicle can exit the space when a corresponding message is displayed on the instrument panel and, in some cases, an acoustic signal sounds. Take charge of the steering with the turning angle set by the Park Assist system.
- Paying attention to the traffic, exit the parking space.

### Automatic operation of the brakes by the parking assist system

Park Assist helps the driver by automatically braking in certain situations.

The driver is always responsible for braking in time >>> .

### Automatic braking intervention to avoid exceeding the speed limit

To avoid exceeding the allowed speed of approx. 7 km/h (4 mph) when entering or leaving a parking space, the brakes may activate automatically. After automatically activating the brakes, the manoeuvres to enter or exit a parking space may continue.

The brakes are only automatically activated once for each attempt to enter or exit a parking space. If the speed of approximately 7 km/h (4 mph) is exceeded again, the corresponding operation is halted.

### Automatic braking to reduce damages

Depending on certain conditions, the Park Assist system can automatically brake the vehicle when faced with an obstacle, briefly actuating and holding down the brake pedal >>> . Following this the driver must press the brake pedal.

Automatic braking intervention to reduce damage leads to the parking manoeuvre finishing.

### WARNING

The automatic braking intervention by Park Assist should never tempt you to take any risk that may compromise safety. The system is not a replacement for driver awareness.

- The Park Assist system is subject to certain limitations inherent to the system. In certain situations, the automatic braking intervention may only work in a limited way or not work at all.
- Always be ready to use the brakes yourself!
- The automatic braking intervention will end after approximately 1.5 seconds. Afterwards, brake the vehicle yourself.

## Parking aid parking and manoeuvring (ParkPilot)

### Introduction

These assist systems help you when parking and manoeuvring:

- **Park assist plus.** It is an assistant that gives a visual and audio warning of obstacles detected in *front* and *behind* the vehicle >>> page 291.
- **Rear parking aid.** An audio and visual assistant that warns of obstacles located *behind* the vehicle >>> page 294.

### ⚠ WARNING

- Always pay attention, by looking directly, to traffic and the area around the vehicle. Assistance systems are not a replacement for driver awareness. Responsibility always lies with the driver.
- The sensors have blind spots in which obstacles and people are not detected. Pay special attention to children and animals.
- Always keep visual control of the surroundings: use the mirrors for additional help.

### ⓘ CAUTION

Parking distance warning system functions can be affected by different factors that can cause damage:

- Under certain circumstances, the system does not detect or display certain objects:
  - Chains, trailer draw bars, bars, fences, posts and thin trees.
  - Objects that are located above the sensors, such as protrusions in a wall.
  - Objects with certain surfaces or structures, such as wire mesh fences or powder snow.
- Certain surfaces of objects and garments do not reflect the ultrasound sensors' signals. The system cannot detect these objects or people wearing such clothes correctly.
- Sensor signals may be affected by external sound sources. This may prevent them from detecting people or objects.
- If the system warns you of the proximity of a low obstacle, please note that after being detected by the system, the obstacle in question may disappear from the measurement sensors as the vehicle moves closer, and the system will no longer warn of its presence. In certain circumstances, objects such as high kerbs that could damage the underside of the vehicle are not detected.
- If the parking distance warning system is ignored, the vehicle could suffer considerable damage.

- Damage to the radiator grille, bumper, wheel arch and vehicle underbody can modify the orientation of the sensors. This can affect the parking aid function. Have the function checked by a specialised workshop.
- A number plate or number plate holder with dimensions that exceed the space for the number plate, or a cured or deformed number plate can cause false detections or a loss of visibility for the sensors.

### ⓘ Note

- The display on the Easy Connect screen shows a slight time delay.
- In certain situations, the system can give a warning even though there is no obstacle in the detected area;
  - rough or cobbled surfaces or with long grass,
  - external ultrasound sources, such as other vehicles equipped with ultrasound systems,
  - downpours, heavy snow, hail or dense exhaust gases,
  - if the number plate is not perfectly secured to the bumper surface,
  - in gradient changes.
- In order to guarantee good operation, keep the sensors clean, free of snow and ice, and do not cover them with stickers or other objects.

- If you use high-pressure or vapour equipment for cleaning, do not apply it directly, unless you do so very briefly, and always keep a distance of more than 10 cm away.
- Fitting certain accessories to the front of the vehicle, such as a plate holder with advertising, may interfere with the operation of the Park Assist.
- We recommend that you practice parking in an area without traffic.
- The volume and tone of the signals and indications can be changed >>> page 295.
- Please observe information on towing a trailer >>> page 295.

### Parking System Plus\*

#### Description

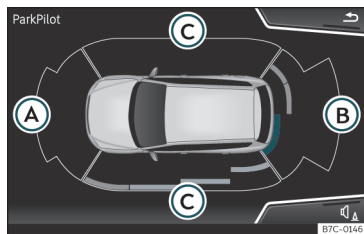

**Fig. 238** Parking Aid display on the Easy Connect system screen.

**Parking aid plus** assists the driver by giving visual and audio warnings about obstacles detected in front of and behind the vehicle.

The bumpers are fitted with sensors. When an obstacle is detected, it is indicated by audible signals and in the Easy Connect system >>> **Fig. 238**.

When moving close to an obstacle, it is possible to know if the obstacle is in front of the vehicle or behind it by choosing different sounds.

The approximate measurement range of the sensors is:

- Ⓐ 1.20 m
- Ⓑ 1.60 m
- Ⓒ 0.90 m

As you approach the obstacle, the frequency of the audible signals will increase. The signal will sound continuously at around 0.30 m: Stop!

If separation is maintained, the warning volume reduces after about 4 seconds.

In order to view the entire periphery of the vehicle, the vehicle must be moved a few metres forwards or backwards. Thus, the missing areas are screened and obstacles at the sides of the vehicle are displayed Ⓒ.

#### Special features of ParkPilot with Area View

In the following situations the screened area on the side of the vehicle is automatically hidden:

- When a vehicle door is opened.
- When the ASR is switched off.
- When there is ASR or ESC regulation.
- If the vehicle remains stationary for more than approximately 3 minutes.

#### Parking Aid operation

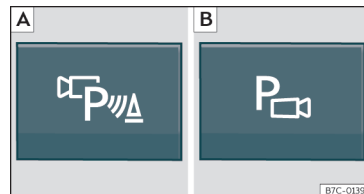

**Fig. 239** Centre console: parking aid button (depending on the version).

#### Manually connecting and disconnecting the parking aid

- Press the **P** button *once*.

»

### Manual disconnection of Parking Aid display (the audible sounds remain active)

- Press a button on the main menu of the factory-assembled infotainment system.
- **OR** press the **BACK** function button.

### Automatic connection of Parking Aid

- Select reverse gear.
- **OR:** If you drive forward at a speed of less than 15 km/h (9 mph) and you encounter an obstacle, it is detected when it is approx. less than 95 cm. away. If the automatic connection is activated, a reduced display is shown >>> **Fig. 240.**
- **OR:** if the vehicle moves backwards.

### Automatic disconnection of Parking Aid

- Move the selector lever to position **P**.
- **OR:** drive forwards at 15 km/h (9 mph) or faster.

### Temporary suppression of sound in Parking Aid

- Press the **🔇** function button.

### Change from reduced view to full view

- Select reverse gear.
- **OR:** press the car icon on the reduced view.

### Switch to the reverse assist image (Rear View Camera “RVC”)

- Select reverse gear.
- **OR** press the **RVC** function button.

A short confirmation signal will be heard and the button symbol will light up when the system is switched on.

### Automatic activation

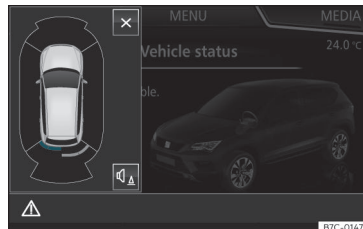

**Fig. 240** Miniature indication of automatic activation.

When the **parking aid plus** connects automatically, a diagram of the vehicle and the segments will appear on the left of the display >>> **Fig. 240.**

It only operates every time the speed is reduced below 15 km/h (9 mph) for the first time.

If it is switched off using the **P** button, one of the following actions must be taken for it to reactivate automatically:

- Switch off the ignition and switch it on again.
- **OR:** drive forward at over 15 km/h (9 mph) approx.
- **OR:** move the lever into position **P** and park again.
- **OR:** switch the automatic activation on and off in the Easy Connect system.

The automatic activation of the parking aid can be switched on and off in the Easy Connect system >>> **page 80:**

- Switch the ignition on.
- Select: Infotainment button **☰** > **SETTINGS** > **Parking and manoeuvring.**
- Select **Automatic activation**. If the box is checked , the function is connected.

If activated automatically, an audible sound warning will only be given when obstacles in front are at a distance of less than 50 cm. approx.

### ⓘ CAUTION

The automatic connection of the Parking Aid only works when you are driving slowly.

If driving style is not adapted to the circumstances, an accident and serious injury or damage may be caused.

### Visual indication segments

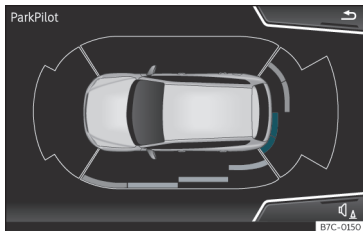

**Fig. 241** Parking Aid display on the Easy Connect system screen.

The optical indication of the segments works as follows:

**White segments:** the obstacle is more than approx. 30 cm away from the path or in the opposite direction of travel. They are also displayed when the electronic parking brake is activated.

**Yellow segments:** the obstacles lie on the vehicle's path and are at a distance of less than approx. 30 cm away.

**Red segments:** obstacles are less than approx. 30 cm away.

In addition, yellow lines indicate the vehicle's expected path based on turns of the steering wheel.

If an obstacle is located in the vehicle's way, the corresponding audible warning will sound.

When the penultimate segment is displayed, the vehicle has reached the collision zone. In the collision zone, the obstacles are represented in red, including those out of the path. Stop the vehicle! >>> in Introduction on page 290, >>> in Introduction on page 290!

In the event the car is equipped with the Top View Camera system, Park Assist visual guidance will appear in accordance with the view selected in the Top View Camera system.

### Setting the indications and audio signals

The indications and audio signal settings are in Easy Connect\* >>> page 80.

#### Automatic activation

on –  off.

#### Front volume\*

Volume in the front and rear area.

#### Front sound settings/sharpness\*

Sound tone in the front area.

#### Rear volume\*

Volume in the rear area.

#### Rear sound settings/sharpness\*

Sound tone in the rear area.

#### Adjust volume

When the parking aid is switched on, the volume of the audio source will be reduced, depending on the selected option.

### Error messages

If an error or fault message appears on the instrument panel in Parking assist, there is a fault.

If the fault doesn't disappear before disconnecting the ignition, it will not be indicated next time the parking aid is connected.

If a rear sensor is faulty, only the obstacles in area are displayed >>> Fig. 238. If a front sensor is faulty, only the obstacles in area are displayed. Symbol is displayed.

We recommend taking the vehicle to a specialised workshop to have the fault repaired.

## Trailer mode

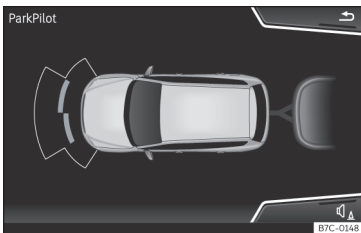

**Fig. 242** Parking assist display on the screen with trailer attached.

On vehicles with a factory-fitted trailer hitch, when the trailer is connected, the rear sensors will not activate when reverse gear is engaged or button **P** is pressed. Therefore, any objects behind or to the side of the vehicle will not be indicated on the screen and no audio signals will sound.

The screen will only display objects detected at the front, and the vehicle's trajectory will be hidden.

## Manoeuvre braking function\*

✓ Only valid with Parking System Plus

The emergency braking function is used to minimise damage in the event of a collision.

Depending on the equipment, if the Parking Aid is active, the braking while manoeuvring function activates emergency braking when it detects an obstacle in the vehicle's path that could cause a collision, driving forwards or in reverse.

The function will not brake if the Parking Aid is activated automatically. For the system to operate, manoeuvring speed must be between 2.5 and 10 km/h (between 1.5 and 6 mph) for the front area and between 1.5 and 10 km/h (between 1 and 6 mph) for the rear.

Following an intervention, the braking while manoeuvring function will be inactive in the same direction of travel for 5 metres. Once the gear is changed, or the selector lever's position is changed, the function will be active again. The Parking Aid's limitations apply.

The braking while manoeuvring function is controlled in the Easy Connect system with the button **⚙** > **SETTINGS** > **Parking and manoeuvring**.

- **on** – permits the use of the braking while manoeuvring function.
- **off** – does not permit the use of the braking while manoeuvring function.

## Temporary suppression of emergency braking

- When the function is deactivated with the **Manoeuvre braking** button that appears on the **Parking assist** screen of the Easy Connect system.
- Whenever any of the car doors, rear lid or bonnet are opened.

## Rear parking aid\*

### Description

The **rear parking aid** is an audible and visual assistant that warns of obstacles located *behind* the vehicle.

There are sensors integrated in the rear bumper. When they detect an obstacle, you are alerted by audible warnings and visually on the Easy Connect system.

If the Top View Camera\* is installed, the rear parking aid will issue an audible warning about objects near the rear of the vehicle, and the Top View Camera\* image will be available on the Easy Connect screen, giving a real image of the objects around the car.

Make particularly sure that the sensors are not covered by adhesives, residues, dirt and the like, as this could affect the system's operation. Cleaning instructions >>> page 344.





The approximate measurement range of the rear sensors is:

Side area: 0.60 m

Central area: 1.60 m

As you approach the obstacle, the frequency of the audible signals will increase. The signal will sound continuously at around 0.30 m:

Stop! >>>  in Introduction on page 290,  
>>>  in Introduction on page 290!

If the separation is maintained, the warning volume is reduced after about 4 seconds.

### Parking Aid operation

#### Parking Aid connection

- Select reverse gear.

#### Parking Aid disconnection

- Place the selector level in position **P**, **N** or **D** (for automatic gearboxes) or disengage reverse (for manual gearboxes).

Set the lever to the **N** or **D** position to maintain the system active for approximately 8 seconds before switching off. During that time, Parking assist will switch off if:

- The selector lever is moved to position **P**.
- **OR**: the vehicle accelerates to approx. 15 km/h (9 mph) or faster.

If the Top View Camera\* is installed, rear parking aid will be automatically deactivated when disengaging reverse gear.

#### Manual disconnection of Parking Aid display (the audible sounds remain active)

- Press a button on the main menu of the factory-assembled infotainment system.
- **OR** press the **BACK**  function button.

#### Temporary suppression of sound in Parking Aid

- Press the  function button. If you have the Top View Camera\* system installed, you cannot use the temporary suppression of sound in Parking Aid.

#### Change from reduced view to full view

- Select reverse gear.
- **OR**: on vehicles fitted with reverse assist (Rear View Camera “RVC”) click on the car icon of the reduced display.

#### Switch to the reverse assist image (Rear View Camera “RVC”)

- Select reverse gear.
- **OR**: press the **RVC** function button.

#### Setting the indications and audio signals

The indications and audio signal settings are in Easy Connect\* >>> page 80.

- **Rear volume\***: volume in the rear area.
- **Rear sound settings/treble\***: sound tone in the rear area.
- **Lower volume\***: when the parking aid is switched on, the volume of the audio source will be reduced, depending on the selected option.

#### Error messages

If an error or fault message appears on the instrument panel in Parking assist, there is a fault.

If the fault doesn't disappear before disconnecting the ignition, it will not be indicated next time the parking aid is connected.

If there is a fault in a sensor, the  symbol is displayed on the Easy Connect display.

We recommend taking the vehicle to a specialised workshop to have the fault repaired.

#### Towing device

In vehicles equipped with a towing bracket device from the factory, when the trailer is connected, the parking aid will not be activated when reverse gear is engaged.

## Visual indication segments

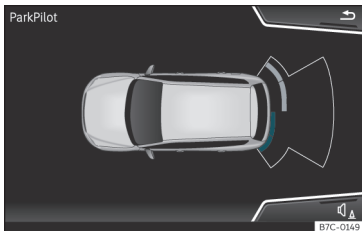

**Fig. 243** Parking Aid display on the Easy Connect system screen.

The distance to the obstacles can be estimated with the help of the segments at the rear of the vehicle.

The optical indication of the segments works as follows:

**White segments:** the obstacle is more than approx. 30 cm away from the path or in the opposite direction of travel. They are also displayed when the electronic parking brake is activated.

**Yellow segments:** the obstacles lie on the vehicle's path and are at a distance of less than approx. 30 cm away.

**Red segments:** obstacles are less than approx. 30 cm away.

Whenever the obstacle is located in the vehicle's direction of travel, the corresponding audible warning will sound.

As the vehicle approaches an obstacle, the segments are displayed closer to the vehicle. When the penultimate segment is displayed, this means that the vehicle has reached the collision zone. In the collision zone, the obstacles are represented in red (including those out of the path). Do not continue to reverse >>> ⚠ in Introduction on page 290, >>> Ⓛ in Introduction on page 290 !

### If you are equipped with the Top View Camera\*

Segments are not displayed when the vehicle is equipped with Top View Camera\*.

The Parking Aid system will issue an audible warning for objects that are near the rear of the vehicle, and the Top View Camera\* image will be available on the screen, giving a real image of the objects around the car.

## Peripheral view system (Top View Camera)\*

### Introduction

Using 4 cameras, the system generates a representation that is shown on the infotain-

ment system display. The cameras are located on the radiator grille, the exterior mirrors and the rear lid.

The functions and representations of the Area View system may vary depending on whether or not the vehicle has ParkPilot.

### ⚠ WARNING

The image from the cameras does not make it possible to calculate the distance to the obstacles (people, vehicles, etc.) precisely, so using them could cause serious accidents and injury.

- The camera lenses augment and distort the visual field and the objects on the screen are seen differently and imprecisely.
- Certain objects may not be shown or may not be shown very clearly, for example, posts or thin rails, due to the screen resolution or if light conditions are insufficient.
- The cameras have blind spots in which obstacles and people are not registered.
- The camera lens must be kept free, without snow or ice, and should not be covered.

### ⚠ WARNING

The smart technology incorporated into the Top View Camera\* system cannot overcome the limits imposed by the laws of physics and it only works within the limits of the system. The greater convenience provided by the Area View system should never

tempt you to take any risk that may compromise safety. If used negligently or involuntarily, it may cause serious accidents and injuries. The system is not a replacement for driver awareness.

- Adapt your speed and driving style to suit visibility, weather, road and traffic conditions.
- Do not be distracted from the traffic by looking at the screen.
- Monitor the area around the vehicle at all times, since the cameras do not capture small children, animals and certain objects in all situations.
- The use of a number plate may interfere in the views shown on the screen, since the cameras' field of vision may be reduced.
- The system will probably be unable to represent all areas clearly.

### ⓘ CAUTION

- The camera images are only two-dimensional. Due to a lack of spatial depth, objects that jut out or holes on the road, for example, are more difficult to detect or may not be seen at all.
- In certain circumstances, the camera does not capture objects such as beams, fences, posts or thin trees, which could damage the vehicle.
- The system displays the auxiliary lines and boxes regardless of the vehicle's envi-

ronment, no objects are detected. The driver is responsible for determining that the vehicle will fit in the parking space.

### ⓘ CAUTION

In order to guarantee good system operation, keep the cameras clean, free of snow or ice, and do not cover them with adhesives or other objects.

- Never use abrasive cleaning products to clean the camera lenses.
- Do not use hot or warm water to remove ice or snow from the camera lenses. Doing so could damage the lenses.

## Area View system

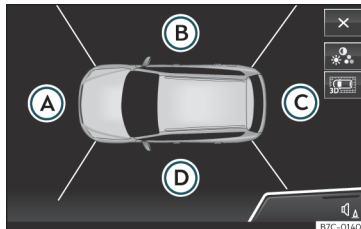

Fig. 244 Viewing the top view system: aerial view.

There are four different views to choose from:

- Ⓐ Front camera area
- Ⓑ Right camera area
- Ⓒ Rear camera area
- Ⓓ Left camera area

Function buttons Fig. 244:

- ✕ Exit the current display.
- ☀️ Adjust the display: bright, contrast and colour.
- 3D Three-dimensional views
- 🔊 Depending on the equipment: connecting and disconnecting the ParkPilot sound.

The aerial view is generated by combining the images from all the cameras (📷) >>> Fig. 244. The aerial view can be selected by pressing the *vehicle* in the area.

Select the corresponding view by pressing the different areas >>> Fig. 244 Ⓐ to Ⓓ of the aerial view or the reduced aerial view.

### Conditions necessary for the use of the Area View system

- The doors and the rear lid must be closed.
- The image must be reliable and clear. For this reason, for example, the camera lens must be clean.
- The area around the vehicle must be clear-ly and totally visible. »

- The area for parking or manoeuvring should be a flat surface.
- The vehicle should **not** be loaded very heavily at the rear.
- The driver must be used to the system.
- There should be no damage to the vehicle in the camera area. If the position or installation angle of the cameras have been changed, e.g. after a rear-end collision, the system should be checked by a specialised workshop.

### Special characteristics

The images on the area view system cameras are only two-dimensional. Due to a lack of spatial depth, it is difficult or impossible to make out on-screen any holes there may be on the ground, objects jutting out from the ground or parts protruding from other vehicles.

Situations in which the objects or other vehicles appear to be further away or closer than they really are:

- On moving from a horizontal plane to a slope.
- On moving from a slope to a horizontal plane.
- If the vehicle is heavily loaded at the rear.
- If the vehicle approaches protruding objects. These objects may be outside the cameras' angle of visibility.

### Trailer mode

The Area View system conceals, in the rear camera area, all the auxiliary guiding lines when the factory-fitted towing bracket is connected electrically to a trailer >>> page 303.

#### Note

**To become familiar with the system and its functions, CUPRA recommends that you practice handling the Area View system in an area where there is not too much traffic or in a car park.**

### Connecting and disconnecting

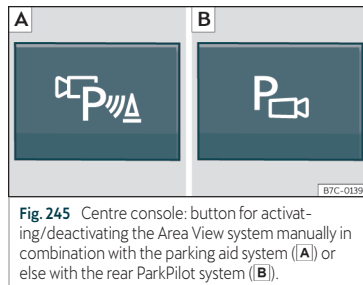

**Fig. 245** Centre console: button for activating/deactivating the Area View system manually in combination with the parking aid system (A) or else with the rear ParkPilot system (B).

### Manual activation

- Press button  $\text{P}_{\text{AV}}$  *once* >>> Fig. 245.

The infotainment system screen displays the aerial view >>> Fig. 244. If you press the  $\text{P}_{\text{AV}}$  button when driving at over 15 km/h (9 mph), the image will not be displayed.

### Automatic activation

- Select reverse gear.
- **OR:** The vehicle moves backwards.

The view of the image of the vehicle's rear camera is shown in parallel parking mode with the reduced aerial view.

### Manual disconnection

- Press button  $\text{P}_{\text{AV}}$  *again* >>> Fig. 245.
- **OR:** press a button on the factory-equipped infotainment system, for example the  $\text{P}_{\text{AV}}$  button.
- **OR:** press the X function button.



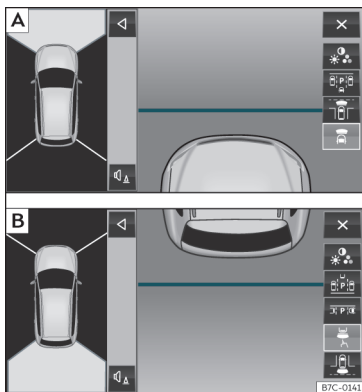

### Automatic off

- Drive forwards at over 15 km/h (9 mph) approximately.
- **OR:** switch off the ignition. The Area View system menu disappears immediately.

### Views of the peripheral vision system (modes)



**Fig. 246** Display on the top view system screen:  
**A** Front camera: off-road view. **B** Rear camera: off-road view.

-  Depending on the equipment: connecting and disconnecting the ParkPilot sound.
-  Showing the reduced display.
-  Hiding the reduced display.
-  Exiting the Area View system screen:

-  Adjust the display: bright, contrast and colour.

The selected view is displayed on the right side of the screen. The reduced aerial view shown on the right side displays the view framed in yellow. In addition, the right margin of the screen displays the menu options possible and the views (the so-called “modes”) of the camera in question. The active view (mode) at the time is highlighted.

The reduced aerial view can be hidden by pressing the < symbol to thus display the selected view full-screen.



The red lines indicate a distance of approx. 40 cm away from the vehicle.

### Aerial views (bird's eye view)

*Main mode:*

-  The vehicle and its immediate vicinity seen from above are shown. Depending on the equipment, the ParkPilot's path may also be displayed.

*Three-dimensional views:*

-  The vehicle and its vicinity seen from above are shown.
-  The vehicle and its vicinity seen from above are shown obliquely.
-  The vehicle and its vicinity seen obliquely are shown.

Swipe the infotainment system display with your finger in the direction of the arrows to change the angle of vision in the three-dimensional views of the vehicle and its vicinity.

### Front camera views (front view)

 Cross traffic. This visualization helps to monitor traffic to the left, front and right of the vehicle and can be used, for example, when exiting garages or narrow exits.

 Angle parking. The area in front of the vehicle is shown. Orientation lines are shown to give guidance.

 Off-road. The area directly in front of the vehicle seen from above is shown. For example, on a slope, in order to see the area directly in front of the vehicle.

### Side camera views (side view)

 Right and left sides. The areas located directly to the side of the vehicle seen from above are represented in order to navigate possible obstacles more precisely.

 The driver's or passenger's side seen from above is shown. This makes it possible to visualize the blind spots along the vehicle. »

## Rear camera views (rear view)

 Angle parking. The area behind the vehicle is shown. Auxiliary lines are shown to give guidance.

 Parallel parking. The area directly behind the vehicle is shown. The coloured boxes and auxiliary lines serve as orientation.

 Off-road or hitching a trailer function. The vehicle's rear is presented.

Green and red semicircular auxiliary lines are displayed in vehicles with a factory-fitted towing bracket. The auxiliary lines indicate the distance from the towing bracket. The distance between the auxiliary lines (green and red) is approx. 30 cm. The orange auxiliary line indicates, according to how the steering wheel is turned, the precalculated direction of the towed device.

 Cross traffic. This visualization helps to monitor traffic to the left, front and right of the vehicle and can be used, for example, when exiting garages or narrow exits.

## Reverse Assist (Rear View Camera)\*

## Operating and safety warnings

 WARNING

- The reverse assist does not make it possible to precisely calculate the distance from obstacles and nor can it overcome the system's own limits, hence its negligent use may cause serious accidents and injuries if used without due care. The driver should be aware of his/her surroundings at all times to ensure safe driving.
- The camera lens expands and distorts the field of view and displays the objects on the screen in a way that is different from reality. Distance perception is also distorted.
- Due to the screen resolution or light conditions, some items may be blurry or not displayed at all. Take care with thin posts, fences, railings or trees that might not be seen on the screen and could damage the vehicle.
- The reverse assist has blind spots where it cannot see people or objects. Monitor the vehicle's surrounding area at all times.
- Keep the camera lens clean, free of ice and snow, and do not cover it.
- The system is not a replacement for driver awareness. Supervise the parking ma-

oeuvre and the vehicle's surrounding area at all times.

- Do not be distracted from the traffic by looking at the screen.
- The images are only two-dimensional. Protruding objects or holes in the road, for example, are more difficult to detect or may not be seen at all.
- Vehicle load modifies the representation of the guide lines »» Fig. 248. The width represented by the lines decreases with vehicle load. Pay special attention to the surroundings when the inside of the vehicle of the luggage compartment are loaded.
- In the following situations, objects or other vehicles appear to be further away or closer than they actually are. Pay special attention:
  - If moving from a flat surface to a slope and vice-versa.
  - If the vehicle is heavily loaded.
  - When the vehicle approaches objects that are not on the ground surface or that protrude from it. These objects may be outside the camera angle when reversing.

 Note

- It is important to take great care and pay special attention if the driver is not familiar with the system.

- Reverse assist will not be available if the rear lid is open.

### Usage instructions

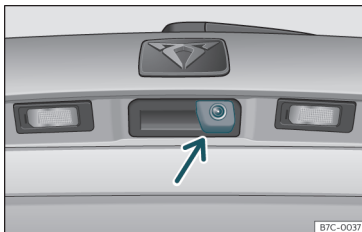

**Fig. 247** In the rear lid handle: location of the reverse assist camera.

A camera installed in the rear lid handle assists the driver with reverse parking or manoeuvring >>> **Fig. 247**.

The camera image is viewed together with orientation lines projected on the Infotainment system screen. Part of the bumper can be seen at the bottom, which can be used by the driver as a reference point.

### Rear assist settings

Rear assist offers the user the possibility to change the image's *brightness*, *contrast* and *colour* settings.

To change these settings:

- Stop the vehicle in a safe place without switching off the ignition or the infotainment system.
- Apply the parking brake.
- Select reverse gear.
- Press the  function button displayed on the screen.
- Make the desired adjustments on the menu by pressing the  $-/+$  function buttons or by moving the scroll button.

### Requirements for parking and manoeuvring with the rear assist

The system should not be used in the following cases:

- If the image displayed is not very reliable or is distorted, or if the lens is dirty.
- If the area behind the vehicle is incomplete.
- If the vehicle is heavily loaded.
- If the position of the camera has changed after a rear-end collision. Have the system checked by a specialised workshop.

### Familiarising yourself with the system

To familiarise yourself with the system, the orientation lines and their function, CUPRA recommends practising in a place without

too much traffic or in a car park when there are good weather and visibility conditions.

### Cleaning the camera lens

Keep the camera lens clean and clear of snow and ice:

- Moisten the lens using a normal alcohol-based glass cleaning product and clean the lens with a dry cloth.
- Remove snow using a small brush.
- Use de-icing spray to remove any ice.

### ⓘ CAUTION

- Do not use abrasive cleaning products to clean the camera lens.
- Do not use hot or warm water to remove ice or snow from the camera lens, as it could be damaged.

## Parking and manoeuvring with reverse assist

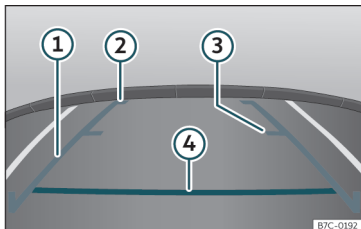

**Fig. 248** Display on the Easy Connect system screen: guide lines.

### Meaning of the orientation lines

»» **Fig. 248**

- ① **Lateral lines:** extension of the vehicle (approximately in its total width) on the road.
- ② **End of the side lines:** approx. 2 m behind the vehicle on the road.
- ③ **Intermediate line:** approx. 1 m behind the vehicle on the road.
- ④ **Horizontal red line:** a safe distance of approx. 40 cm at the rear of the vehicle on the road.

<sup>1)</sup> The RVC button will only be displayed when reverse gear is engaged.

### Switching the system on and off

- Reverse assist is connected by a contact when engaging reverse gear.
- The system switches off 8 seconds after disengaging reverse gear and immediately after removing the contact.
- The camera will stop transmitting images above the speed of 15 km/h (9 mph) with reverse engaged.

In combination with the parking aid plus system »» page 291, the camera image will no longer be displayed when reverse gear is disengaged, and the system will display the optical information provided by the parking aid system.

It is also possible to hide the reverse assist image:

- By pressing one of the Infotainment system buttons on the display.
- **OR:** by clicking on the miniature vehicle shown on the screen.

If you wish to display the rear assist image again:

- Disengage and re-engage reverse gear.
- **OR:** Press the **RVC** function button<sup>1)</sup>

### Parking manoeuvre

- Stop the vehicle in front of a space and select reverse gear.
- Reverse slowly, and turn the steering wheel so that the side lines lead towards the parking space.
- Guide the vehicle into the parking space so that the side lines run parallel to it.



## Towing bracket device\*

### Trailer mode

#### Introduction

Take into account country-specific regulations about driving with a trailer and the use of a towing bracket.

The vehicle has been developed primarily for carrying people, although it can also be used to tow a trailer if fitted with the corresponding technical equipment. This additional load has an effect on the useful life, fuel consumption and vehicle performance and in some cases can reduce the service intervals.

Driving with a trailer requires more force from the vehicle, and thus more concentration from the driver.

In winter, winter tyres should be fitted on both the vehicle **and** the trailer.

#### Maximum vertical load technically permitted on the coupling device

The *maximum* vertical load technically permitted from the trailer draw bar on the towing bracket's tow ball is **88 kg**.

#### Vehicles with the Start-Stop system

If the vehicle has a factory-fitted towing bracket or one that is retrofitted by CUPRA,

the Start-Stop system operates as normal. No special characteristics need to be taken into account.

If the system does not recognise the trailer or the trailer bracket has not been retrofitted by CUPRA, the Start-Stop system must be disconnected by pressing the corresponding button in the lower part of the centre console before driving with the trailer, and it should remain off for the rest of the journey >>> ⚠.

#### Vehicles with driving profile selection

If you are going to be towing a trailer, the use of the **Eco** driving profile is not recommended. You are advised to select another of the available driving profiles before beginning to drive with a trailer.

#### Trailer weight/drawbar load

Never exceed the authorised trailer weight. If you do not load the trailer up to the maximum permitted trailer weight, you can then climb correspondingly steeper slopes.

The maximum trailer weights listed are only applicable for **altitudes** up to 1000 m above sea level. Since higher altitude decreases engine performance and the ability to climb slopes, the tow load decreases proportionally. The weight of the vehicle and trailer combination must be reduced by 10% for every 1000 m of altitude. When possible, operate

the trailer with the maximum **authorised drawbar load** on the ball joint of the towing bracket, but **do not exceed** the specified limit.

#### ⚠ WARNING

Never use the trailer to transport people, since it would put their life in danger and is also prohibited.

#### ⚠ WARNING

Undue use of the towing bracket may cause injury and accidents.

- Only use the towing bracket if it is in a perfect state of repair and is properly secured.
- Never modify or repair the towing bracket in any way.
- In order to reduce the danger of injury in the event of rear-end collisions and to avoid injury to pedestrians and cyclists when parking the vehicle, cover or remove the tow hook when you are not using a trailer.
- Never fit a towing bracket "with weight distribution" or "load compensation". The vehicle has not been designed for this type of towing bracket. The towing bracket could fail and the trailer could be released from the vehicle.

»

**⚠ WARNING**

Driving with a trailer and transporting heavy or large objects can affect driving properties and even cause an accident.

- Always secure the load properly using belts or straps that are suitable and in good condition.
- Adapt your speed and driving style at all times to suit visibility, weather, road and traffic conditions.
- Trailers with a high centre of gravity are more likely to overturn than those with a low one.
- Avoid sudden braking and manoeuvres.
- Take great care when overtaking.
- Reduce speed immediately if you notice that the trailer is swaying, however slightly.
- Never drive at more than 80 km/h (50 mph) when towing a trailer (or at more than 100 km/h (60 mph) in exceptional circumstances). This also applies in countries where driving at higher speeds is permitted. Take into account the speed limit for vehicles with trailers in the corresponding country, as it could be less than the speed limit for vehicles without a trailer.
- Never attempt to “straighten” the towing vehicle and trailer while accelerating.

**⚠ WARNING**

If the towing bracket has been retrofitted by a non-CUPRA workshop, the Start-Stop

system must be disconnected manually whenever driving with a trailer. Otherwise the brake system could be damaged and could consequently cause a serious accident or injury.

- Always disconnect the Start-Stop system manually when using a towing bracket that has not been fitted by a CUPRA workshop.

**i Note**

- Before hitching or unhitching a trailer, always deactivate the anti-theft alarm >>> page 87. Otherwise, the tilt sensor could cause the alarm to go off.
- Do not drive with a trailer for the engine's first 1000 km >>> page 243.
- CUPRA recommends that, if possible, the tow hook be removed or covered when it is not going to be used. In the event of a rear-end collision, the damage to the vehicle could be greater if the tow hook is fitted.
- Some retrofitted towing brackets cover the rear towing eye. In these cases, the towing eye should not be used for tow-starting or for towing other vehicles. For this reason, if the vehicle has been retrofitted with a towing bracket, always keep the tow hook in the vehicle when you remove it.

**Technical requirements**

Vehicles that are **factory**-equipped with a towing bracket fulfil all the technical and legal requirements for driving with a trailer.

If the **vehicle is retrofitted** with a towing bracket, only a bracket that is authorised for the maximum authorised load of the trailer that is to be towed may be fitted. The towing bracket must be suitable for the vehicle and the trailer and must be properly secured to the vehicle's chassis. Only use a towing bracket that has been authorised by CUPRA for this vehicle. Always check and take into account the towing bracket manufacturer's instructions. Never fit a towing bracket “with weight distribution” or “load compensation”.

**Towing bracket fitted on the bumper**

Never fit a towing bracket to the bumper or to the area where the bumper is mounted. The towing bracket should not impair the bumper's function. Do not make modifications or repairs to the exhaust system or the brake system. Make regular checks to ensure that the towing bracket is secure.

**Engine cooling system**

Driving with a trailer increases the load on the engine and cooling system. The cooling system should have sufficient coolant and be prepared for the additional effort involved in driving with a trailer.

### Trailer brakes

If the trailer has its own brake system, please take the relevant legal requirements into account. Never connect the trailer's brake system to the vehicle's brake system.

### Tow cable

Always use a cable between the vehicle and the trailer »» page 305.

### Trailer tail lights

The trailer's rear lights should comply with the statutory safety regulations »» page 305.

Never connect the trailer's rear lights directly to the vehicle's electric system. If you are not sure that the trailer's electrical connection is correct, have it checked by a specialised workshop. To do so, CUPRA recommends going to a specialised CUPRA dealer or any SEAT dealership.

### Exterior mirrors

If you cannot see the area behind the trailer with the exterior mirrors of the towing vehicle, additional mirrors will have to be installed in accordance with the regulations of the country in question. The exterior mirrors should be adjusted before you start driving and must provide a sufficient field of vision at the rear.

### Trailer maximum electricity consumption

Never exceed the values indicated!

#### Europe, Asia, Africa, South America and Central America

Brake lights (total)	84 Watts
Turn signal (on each side)	42 Watts
Side lights (on each side)	50 Watts
Reverse lights (in total)	42 Watts
Rear fog light	42 Watts

#### Australia

Brake lights (total)	108 Watts
Turn signal (on each side)	54 Watts
Side lights (on each side)	100 Watts
Reverse lights (in total)	54 Watts
Rear fog light	54 Watts

#### WARNING

**If the towing bracket is wrongly fitted or is not the right one, the trailer could become detached from the vehicle and cause serious injury.**

#### CAUTION

**• If the rear lights of the trailer are not correctly connected, the vehicle's electronic system may be damaged.**

- If the trailer absorbs excessive electric current, the vehicle's electronic system may be damaged.
- Never connect the trailer's electric system directly to the electrical connections of the tail lights or any other power sources. Only use the connections intended for providing electric current to the trailer.

### Hitching and connecting a trailer

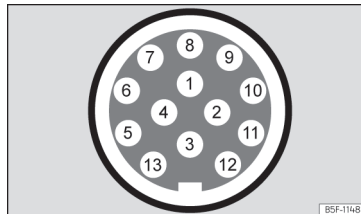

**Fig. 249** Schematic representation: assignment of the pins of the trailer's electrical socket.

Pin	Meaning
1	Left turn signal
2	Rear fog light
3	Earth for pins 1, 2, 4, 5, 6, 7 and 8
4	Right turn signal
5	Rear light, right

»

Pin	Meaning
6	Brake lights
7	Rear light, left
8	Reverse lights
9	Permanent live
10	Live charge cable
11	Earth for pin 10
12	Unassigned
13	Earth for pin 9

### Power socket for trailer

The vehicle is fitted with a 13-pole power socket for the connection between the trailer and the vehicle. With the engine running, electrical devices on the trailer receive power from the electrical connection (pin 9 and pin 10 of the trailer power socket).

If the system detects that a trailer has been connected, the consumers on the trailer will receive electricity through this connection (pins 9 and 10). Pin 9 has a permanent live. This powers, for example, the trailer's interior lighting. Electrical devices such as a fridge in a caravan **only** receive electrical power if the engine is running (through pin 10).

To avoid overloading the electrical system, you cannot connect the ground wires of pin 3, pin 11 or pin 13.

If the trailer has a **7-contact connector**, you will need to use an adapter cable. In this case the function corresponding to pin 10 will not be available.

### Tow cable

The tow rope must always be securely fixed to the towing vehicle and loose enough so that the vehicle can handle turns smoothly. However, make sure that the cable does not rub on the ground while driving.

### Trailer tail lights

Always check the trailer's rear lights to ensure they are working correctly and that they comply with the relevant safety regulations. Make sure that the maximum permissible power that can be absorbed by the trailer is not exceeded >>> page 305.

### Include in the anti-theft alarm

The trailer is included in the anti-theft system if the following conditions are met:

- If the vehicle is factory-equipped with an anti-theft alarm and towing bracket.
- If the trailer is electrically connected to the towing vehicle through the trailer power socket.
- If the electrical systems of the vehicle and trailer are in perfect condition and have no faults or damage.

- If the vehicle is locked with the key and the anti-theft alarm is activated.

When the vehicle is locked, the alarm is triggered if the electrical connection with the trailer is cut off.

Before hitching or unhitching a trailer, always turn off the anti-theft alarm. Otherwise, the tilt sensor could cause the alarm to go off.

### Trailers with LED tail lights

For technical reasons, trailers fitted with LED rear lights cannot be connected to the anti-theft alarm system.

When the vehicle is locked, the alarm does not go off when the electrical connection with the trailer is cut if it has rear lights with light-emitting diodes.

If the **Eco** driving profile was selected when hitching the trailer, this will automatically switch to the **Normal** profile. If the system cannot detect the attached trailer or if the towing bracket has been retrofitted by an auto repair shop other than CUPRA, you must manually select the **Normal** profile before you start driving with a trailer attached. To reconnect the **Eco** profile once the trailer has been unhitched, switch the ignition off and back on once.

### WARNING

If the cables are improperly or incorrectly connected, it may lead to an excessive amount of current supplied to the trailer, which can cause abnormalities in the entire vehicle electronic system, as well as accidents and serious injuries.

- Ensure that any repairs that need to be carried out on the electrical system are carried out by a specialised workshop.
- Never connect the trailer's electric system directly to the electrical connections of the tail lights or any other power sources.

### WARNING

Contact between the pins of the trailer power socket can cause short circuits, overloading of the electrical system or failure of the lighting system, and consequently can cause accidents and serious injuries.

- Never connect the pins of the trailer power socket to each other.
- Make sure any work on bent pins is carried out by a specialised workshop.

### CAUTION

Do not leave the trailer connected to the vehicle when parked; place it on its support wheel or its supports. If the vehicle rises or falls due, for example, to a variation of the load or a burst tyre, increased pressure will

be placed on the towing bracket and the trailer, and both the vehicle and the trailer can be damaged.

### Note

- In case of anomalies in the electrical systems of the vehicle or trailer, as well as in the anti-theft alarm system, have them inspected by a specialised workshop.
- If the trailer accessories consume energy through the power socket to the trailer and the engine is turned off, the battery will discharge.
- If the vehicle battery is running low, the electrical connection with the trailer will be automatically cut.

## Trailer loading

### Technically permissible maximum trailer weight and vertical load on the coupling device

The technically permissible maximum trailer weight is the weight that the vehicle can tow >>> . The vertical load on the coupling is exerted vertically from above on the hook of the towing bracket.

The information on the maximum trailer weight and vertical load on the coupling device contained in the type plate of the towing bracket are experimental values only. The

correct figures for your specific model, which may be lower than these figures, are given in the vehicle documentation. The information in the vehicle documentation takes precedence at all times.

To promote safety while driving, CUPRA recommends making the most of the maximum **vertical load** technically permissible on the coupling device >>> page 303. An insufficient vertical load has a negative influence on the behaviour of both the vehicle and trailer.

The vertical load increases the weight on the rear axle, reducing the vehicle's carrying capacity.

### Gross combination weight of the towing vehicle and trailer

The gross combination weight is the actual weight of the loaded vehicle plus the actual weight of the loaded trailer.

In some countries trailers are classified into distinct categories. CUPRA recommends obtaining information from a specialised workshop regarding which type of trailer is most suitable for your vehicle.

### Trailer loading

The weight of the towing vehicle and trailer must be balanced. In order to do this, the load must be as close as possible to the maximum vertical load technically permissible on the coupling point, and it must be evenly >>>

distributed between the back and front of the trailer:

- Distribute loads in the trailer so that heavy objects are as near to the axle as possible or above it.
- Secure the trailer load properly.

### Tyre pressure

Set the tyre pressure of the trailer tyres in accordance with the trailer manufacturer's recommendations.

When towing a trailer, inflate the tyres of the towing vehicle with the maximum allowable pressure »» page 333.

#### WARNING

If the maximum permissible axle weight, the maximum load technically permissible on the coupling point, the maximum authorised vehicle weight or the gross combination weight of the towing vehicle and trailer are exceeded, accidents and serious injuries may occur.

- Never exceed the values indicated!
- The actual weight on the front and rear axles must never exceed the maximum permissible axle weight. The weight on the

front and rear axles must never exceed the maximum permissible weight.

#### WARNING

A shift in weight could jeopardize the stability and security of the towing vehicle and trailer, which could lead to accidents and serious injuries.

- Always load the trailer correctly.
- Always secure the load properly using belts or straps that are suitable and in good condition.

### Driving with a trailer

#### Adjusting the headlights

The front part of the vehicle may be raised when the trailer is connected and the light may dazzle the rest of the traffic.

Adapt the height of the headlights using the headlight range adjuster »» page 113<sup>1)</sup>.

#### Specific features of driving with a trailer

- If your trailer has an **overrun brake**, brake *gently at first* and then rapidly. This will prevent the jerking that can be caused by the locking of trailer wheels.

- Due to the gross combination weight of the towing vehicle and trailer, the braking distance increases.

- When going down a slope, go into a lower gear (if using a manual gearbox or the tip-tronic automatic gearbox mode) to take advantage of the braking power provided by the engine. Otherwise, the braking system could overheat and even fail.

- The trailer weight, as well as the gross combination weight of the towing vehicle and trailer, change the centre of gravity and the properties of the vehicle.

- If the towing vehicle is empty and the trailer is loaded, then the load distribution is incorrect. Under these conditions, drive slowly and with extra caution.

#### Hill starts with a trailer

Depending on the slope of the hill and the combination weight of the towing vehicle and trailer, the vehicle might start rolling backwards slightly when you first start up.

For hill-starting with a trailer, do the following:

- Press and hold the brake pedal.
- Press the  button once to disconnect the electronic parking brake »» page 276.

<sup>1)</sup> This does not apply for vehicles with Full LED xenon headlights.

## Towing bracket device\*

- If the vehicle is equipped with a manual gearbox, push the clutch pedal all the way down.
- Move the selector lever to the **D/S** >>> page 232 position.
- Pull out the (P) button and hold it in that position to immobilise the towing vehicle and trailer with the electronic parking brake.
- Release the brake pedal.
- Start driving slowly. To do this, in the case of a manual gearbox, slowly release the clutch pedal.
- Do not release the (P) button until the engine has sufficient power to start driving.

### WARNING

If a trailer is pulled incorrectly, this may lead to loss of control of the vehicle and serious injury.

- Driving with a trailer and transporting heavy or large objects will change the vehicle handling and braking distances.
- Always drive cautiously and carefully. Brake earlier than usual.
- Adapt your speed and driving style at all times to suit visibility, weather, road and traffic conditions. Slow down, especially when driving down hills or slopes.
- Accelerate with particular care and caution. Avoid sudden braking and manoeuvres.



- Take great care when overtaking. Reduce speed immediately if you notice that the trailer is swaying, however slightly.
- Never attempt to “straighten” the towing vehicle and trailer while accelerating.
- Take into account the speed limit for vehicles with a trailer, as it could be lower than for vehicles without a trailer.

### Stabilisation of the towing vehicle and trailer combination

The stabilisation of the vehicle and trailer combination is an additional function of the electronic stability control (ESC).

If the vehicle and trailer stabilisation system detects that the trailer is weaving, it takes action on the steering control to reduce the weaving of the trailer.

### Vehicle and trailer combination stabilisation requirements

- The vehicle is factory-equipped with a towing bracket or has been retro-fitted with a compatible towing bracket.
- The ESC and ASR are active. The control lamp  or  is not lit up on the instrument cluster.
- The trailer is connected to the towing vehicle through the trailer power socket.

- The vehicle is travelling at over 60 km/h (approx. 37 mph).
- The maximum vertical load technically permissible is being utilised on the coupling device.
- The trailer has a rigid draw bar.
- If the trailer has brakes, it must be equipped with a mechanical overrun brake.

### WARNING

The enhanced safety provided by the electric stability control of the vehicle and trailer should not lead you to take any risks that could compromise your safety.

- Adapt your speed and driving style at all times to suit visibility, weather, road and traffic conditions.
- Accelerate with caution when the road is slippery.
- When adjusting any settings, stop accelerating.

### WARNING

The electric stability control for the vehicle and trailer may not correctly detect all driving conditions.

- When the ESC is switched off, the stabilisation of the towing vehicle and trailer is also switched off. »

- The stability system does not always detect light trailers, so it may not stabilise these correctly.
- When driving on surfaces with poor grip, the trailer can even *interfere* with the stability system.
- Trailers with a high centre of gravity can tip over without having previously weaved.
- If a trailer is not attached, but a connector is plugged into the power socket (e.g. installation of a bicycle rack with lights), repeated automatic braking may occur in extreme driving conditions.

## Electrically unlocking trailer hook\*

### Description

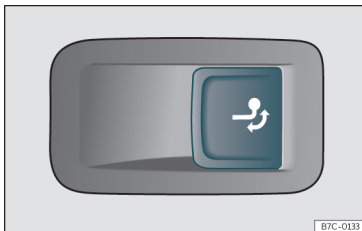

**Fig. 250** On the right side of the luggage compartment: button for unlocking the tow ball.

The towing bracket's hook is located in the bumper. Tow hooks for electrical unlocking cannot be removed.

There should be no person, animal or object in the path of the tow hook >>> .

### Unlocking the tow hook and removing it

- Stop the vehicle and connect the electronic parking brake >>> page 276.
- Switch off the engine.
- Open the rear lid.
- Pull the >>> **Fig. 250** button briefly. The tow hook unlocks electrically and automatically turns outwards. The button's control lamp flashes.
- Finish remove the tow hook by hand until you feel and hear that it has engaged and the control lamp on the button stays on.
- Close the rear lid.

### Retracting the tow hook

- Stop the vehicle and apply the electronic parking brake.
- Switch off the engine.
- Unhook the trailer and interrupt the electrical connection between it and the vehicle. If you are using an adapter, remove it from the trailer's power socket.
- Open the rear lid.

• Pull the >>> **Fig. 250** button briefly. The tow hook unlocks electrically.

• Turn the tow hook under the bumper with your hand until you feel and hear that it engages and the control lamp on the button remains on continuously.

• Close the rear lid.

### The control lamp →

- If the warning light on the button >>> **Fig. 250** → *flashes*, this means that the tow hook has not been attached properly or is damaged. >>> .
- If the warning lamp >>> **Fig. 250** → *remains on* with the rear lid open, the tow hook is correctly in place both when extracted and when covered.

The control light of the lamp switches off approximately 1 minute after closing the rear lid.

### WARNING

Undue use of the towing bracket may cause injury and accidents.

- Only use the tow hook if it is properly engaged.
- Always ensure that no person, animal or object is to be found in the path of the tow hook.
- Never use a tool or instrument while the tow hook is moving.



- Never press the >>> Fig. 250 button when there is a trailer hooked to the vehicle or when a carrier system or other accessories are mounted on the tow hook.
- If the tow hook is not attached properly, do not use it. Instead, go to a specialised workshop and have the towing bracket checked.
- If you detect any fault in the electrical system or in the towing bracket, contact a specialised workshop and ask them to check it.
- If the ball has a diameter of less than 49 mm at any one point, do not use the towing bracket under any circumstances.

### ⓘ CAUTION

If you clean the vehicle with high-pressure or steam devices, do not point the jet directly towards the retractable tow hook or the trailer power socket, as this may damage the joints or remove the grease necessary for lubrication.

### ⓘ Note

At extremely low temperatures, the tow hook may be impossible to operate. In this case, place the vehicle in a warmer location (for example, a garage).

### Fitting a bicycle carrier on the retractable towbar

The maximum allowed weight of the carrier system, including the load, is **75 kg**. The carrier system should not protrude more than 700 mm backwards from the spherical head. Only carrier systems on which up to 3 bikes can be mounted are allowed. Heavier bicycles must be mounted as close to the vehicle as possible (tow hook).

### ⚠ WARNING

The incorrect use of the tow hitch with a bicycle rack mounted on the tow hook can cause accidents and injury.

- Never exceed the maximum weight or the limits indicated above.
- The bicycle rack may not be mounted to the neck of the hook below the ball because, due to the shape of the neck and depending on the rack model, the rack could be incorrectly mounted on the vehicle.
- Always read and take the manufacturer assembly instructions into account.

### ⓘ CAUTION

If the maximum weight and limits indicated above are exceeded, the vehicle may suffer considerable damage.

- Never exceed the values indicated!

### ⓘ Note

CUPRA recommends removing, as far as possible, all removable parts of the bicycles before setting off. These parts include, for example, baskets and saddlebags, child seats or batteries. This improves aerodynamics and the centre of gravity of the rack system.

## Retrofitting a towing bracket

### Description

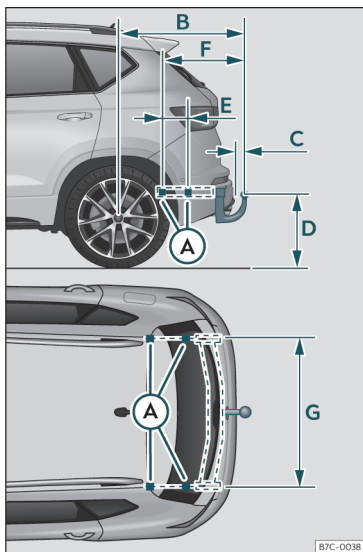

**Fig. 251** Limits and attachment points for retrofitting a towing bracket.

CUPRA recommends that towing brackets be retrofitted at a specialised workshop. For ex-

ample, it may very well be necessary to adjust the cooling system or mount thermal protection plates. To do so, CUPRA recommends going to a specialised CUPRA dealer or any SEAT dealership.

If a towing bracket is retrofitted, the distance specifications should always be kept in mind.

The distance between the centre of the ball head and the road >>> **Fig. 251** **D** must never be less than indicated. This also applies when the vehicle is fully loaded, including the technically permissible maximum vertical load on the coupling device.

#### Distance specifications >>> **Fig. 251:**

- A** Attachment points (lower part of the vehicle)
- B** 950.5 mm
- C** 65 mm min.
- D** 350-420 mm
- E** 220 mm
- F** 633.5 mm
- G** 1,043 mm

#### **⚠ WARNING**

If the cables are improperly or incorrectly connected, this may lead to malfunctions in the entire vehicle electronic system, as well as to accidents and serious injuries.

- Never connect the trailer's electric system to the electrical connections of the tail

lights or any other unsuitable power sources. Only use suitable connectors to connect the trailer.

- The towing bracket should be retrofitted only at a specialised workshop.

#### **⚠ WARNING**

If the towing bracket is badly fitted or unsuitable, the trailer may separate from the vehicle while driving. This could cause serious accidents and fatal injuries.

#### **i Note**

- Only use towing brackets that have been approved by CUPRA for the model in question.
- In some versions, the fitting of a conventional towing hook solution is not recommended. Please consult your Technical Service.

### Practical tips

## Checking and refilling levels

### Refuelling

#### Refuelling

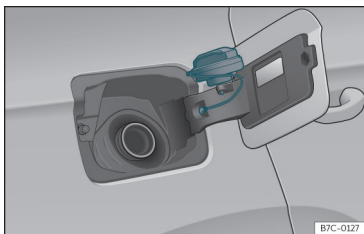

**Fig. 252** Fuel tank flap with tank cap attached.

The fuel tank flap is on the rear right of the vehicle.

The flap that covers the tank cap is unlocked and locked automatically using the central locking.

- Open the fuel tank flap by pressing on the left side.
- Unscrew the cap by turning it to the left.
- Place it in the space on the hinge of the open flap >>> **Fig. 252**.

- Start refuelling. The tank is full as soon as the pump's automatic nozzle cuts off the fuel supply. Do not try to put in more fuel after the nozzle cuts out, as this will fill the expansion chamber in the fuel tank.
- Unscrew the cap by turning it to the right as far as it will go.
- Close the lid.

The correct fuel grade for your vehicle is given on a sticker on the inside of the fuel tank flap. Further notes on fuel can be found at >>> page 314.

The capacity of your vehicle's fuel tank is given in >>> page 355.

#### **⚠ WARNING**

Fuel is highly flammable and can cause serious burns and other injuries.

- When refuelling, turn off the engine and turn off the ignition for safety reasons.
- Do not smoke when filling the fuel tank or a canister. Naked flames are forbidden in the vicinity due to the risk of explosion.
- Observe legislation governing the use, storage and carrying of a spare fuel canister in the vehicle.
- For safety reasons we do not recommend carrying a spare fuel canister in the vehicle. In an accident the canister could be damaged and could leak.

- If, in exceptional circumstances, you have to carry a spare fuel canister, please observe the following points:

- Never fill fuel into the spare fuel canister if it is inside or on top of the vehicle. This could cause an explosion. Always place the canister on the ground to fill it.
- Insert the filling nozzle as far as possible into the spare fuel canister.
- If the spare fuel canister is made of metal, the filling nozzle must be in contact with the canister during filling. This helps prevent an electrostatic charge building up.
- Never spill fuel in the vehicle or in the luggage compartment. Fuel vapour is explosive. Risk of fatal accident!

#### **ⓘ CAUTION**

- If any fuel is spilt onto the vehicle, it should be removed immediately. It could otherwise damage the paintwork.
- Never run the tank completely dry. The catalytic converter can be damaged.
- When filling the fuel tank after having run it completely dry on a vehicle with a diesel engine, the ignition must be switched on for at least 30 seconds before starting the engine. When you then start the engine it may take longer than normal (up to one minute) to start firing.

>>

### For the sake of the environment

Do not overfill the fuel tank, it may cause the fuel to overflow if it becomes warm.

### Note

There is no emergency mechanism for the manual release of the fuel tank flap. If necessary, request assistance from specialised personnel.

### Note

Diesel vehicles are fitted with a protective device that prevents the insertion of the wrong fuel hose<sup>1)</sup>. It is only possible to refuel with Diesel nozzles.

- If the pump nozzle is worn, damaged, or if it is very small, it is possible that it will not be able to open the protective device. Before trying to insert the pump nozzle by turning it, try a different pump or request specialist help.

- If you fill the tank from a reserve fuel canister, the protective device will not open. One way to resolve this is to pour the fuel in very slowly.

## Fuel types

### Identification of fuels<sup>1)</sup>

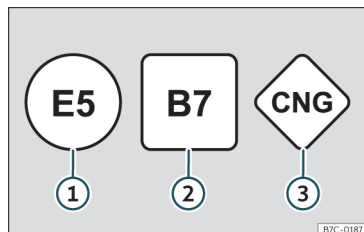

Fig. 253 Identification of fuels according to European Union (EU) Directive 2014/94/

Fuels are identified by different symbols on the pump and on your vehicle's tank flap. The identification serves to prevent confusion when choosing the fuel.

- ① **Petrol** with ethanol ("E" stands for Ethanol). The number indicates the percentage of ethanol in the petrol. "E5" means, for example, an ethanol ratio of 5% max.
- ② **Diesel** with biodiesel ("B" stands for Biodiesel). The number indicates the percentage of biodiesel in the diesel. "B7"

means, for example, a proportion of biodiesel of max. 7%.

- ③ **Natural gas:** "CNG" means Compressed Natural Gas.

### Type of petrol

The correct grade of petrol is listed inside the fuel tank flap.

The vehicle is equipped with a catalytic converter and must only be run on **unleaded petrol**. The petrol must comply with the standard EN 228 and be **sulphur-free**. Fuels with a 10% ethanol ratio can be refuelled (E10)<sup>2)</sup>. The types of petrol are differentiated by using the **octane numbers (RON)** or via the **anti-knock index (AKI)**.

### Unleaded super plus 98 octane petrol or super 95 octane petrol at least

We recommend refuelling with super plus 98 octane petrol (93 AKI). If not available: super 95 octane petrol (91 AKI) (with a slight power loss).

If super is not available, *if necessary*, use normal 91 octane petrol (87 AKI). In this case

<sup>1)</sup> Depending on country

<sup>2)</sup> Follow the regulations of the country you are driving in.

only use moderate engine speeds and a light throttle. Refuel with super as soon as possible.

### ⓘ CAUTION

- Fuels high percentage of ethanol, e.g. E30 - E100 button must not be used. The fuel system would be damaged.
- A single refuelling with leaded fuel or other metal additives entails a permanent deterioration of the effectiveness of the catalytic converter.
- Only use fuel additives that have been approved by SEAT. The products that contain substances to increase the octane rating or decrease knocking may contain metal additives that damage the engine and catalytic converter. This type of products must not be used.
- Do not use fuels shown in the pump as containing metals. LRP (*lead replacement petrol*) fuels contain high concentrations of metal additives. Risk of engine damage!
- High engine speed and full throttle can damage the engine when using petrol with an octane rating lower than the correct grade for the engine.

### ⓘ Note

- Fuel with an octane rating higher than the one required by the engine can be used.

- In countries in which there is no sulphur-free fuel, it is also allowed to use low sulphur content fuel.

## Engine management and emissions control system

### Introduction

#### ⚠ WARNING

- Due to the high temperatures reached by the exhaust gas scrubbing system, you should not park your vehicle near a surface that can catch fire easily. Fire hazard!
- Do not apply wax underneath the vehicle around the area of the exhaust system: Fire hazard!

### Control lamps

#### It lights up

Fault in the emission control system. Reduce speed and drive carefully to the nearest specialised workshop to have the engine checked.

#### Flashes

Combustion failures that can damage the catalytic converter. Reduce speed and drive carefully to the nearest specialised workshop to have the engine checked.

#### It lights up

Particulate filter blocked >>> page 316.

#### EPC It lights up

Fault in the petrol engine management. Have the engine checked as soon as possible by a specialised workshop.

When the ignition is switched on, the **EPC** (Electronic Power Control) lights up and should go off once the engine has started.

#### ⓘ Note

While the control lamps  or **EPC** are on, there might be faults in the engine, fuel consumption may go up and the engine might lose power.

### Catalytic converter

To maintain the useful life of the catalytic converter

- Only use unleaded petrol with petrol engines.
- Never run the fuel tank dry.



- When changing or adding engine oil, do not exceed the necessary amount  
»» page 321, Topping up the engine oil.
- Never tow the vehicle to start it, use jump leads if necessary »» page 46.

If you should notice misfiring, uneven running or loss of power when the car is moving, have the vehicle inspected by a specialised workshop. In general, the emissions warning lamp  will light up when any of these symptoms occur. If this happens, any unburnt fuel can enter the exhaust system and escape into the atmosphere. The catalytic converter can also be damaged by overheating.

### CAUTION

Never run the fuel tank completely dry because an irregular fuel supply can cause ignition faults. This allows unburnt fuel to enter the exhaust system, which could cause overheating and damage the catalytic converter.

### For the sake of the environment

Even when the emission control system is working perfectly, there may be a smell of sulphur from the gases on occasions. This depends on the sulphur content of the fuel used. This can quite often be avoided by changing to another brand of fuel.

## Particulate filter

The particulate filter eliminates most of the soot from the exhaust gas system. Under normal driving conditions the filter cleans itself. If the filter does not clean itself (e.g. if short journeys are made continuously), it becomes blocked with soot and the following indication is displayed to the driver:  **Particulate filter: cleaned while the vehicle is moving.** See Manual. The particulate filter needs cleaning (regeneration).

### Regeneration of the particulate filter

*Requirements for the regeneration journey:* the engine is at operating temperature.

- Drive at a speed of at least 80 km/h »» 
- Completely remove your foot from the accelerator pedal for a few seconds to let the vehicle roll with the gear engaged.
- Repeat this procedure (accelerate and let roll) until the control lamp turns off.

This procedure involves an autonomous particulate filter cleaning process and may take some time.

If the warning lamp **does not turn off**, go immediately to a specialised workshop to repair the fault.

### WARNING

Always adjust your speed to suit the weather conditions, roads, braking distance and traffic if the particulate filter is in its regeneration phase. Route recommendations should never make you disregard each country's specific traffic regulations.

### CAUTION

- Due to the high temperatures caused by the regeneration of the particulate filter, it is possible that the radiator fan will activate after stopping the engine, even if its operating temperature has not been reached.
- Noise, smells and high idle speeds can occur during regeneration.
- Always use the correct engine oil and the correct fuel to make sure the useful life of the particulate filter is not affected. Also avoid making short trips all the time.

## Engine compartment

### Working in the engine compartment

Always be aware of the danger of injury and scalding as well as the risk of accident or fire when working in the engine compartment (e.g. when checking and refilling fluids).

Always observe the warnings listed below and follow all general safety precautions.

The vehicle's engine compartment is a potentially hazardous area >>> .

### WARNING

When work is done in the engine compartment, injuries, burns, accidents and even fires can occur.

- Switch the engine off, remove the key from the ignition and apply the electronic parking brake. If the vehicle has a manual gearbox, place the lever in neutral; if it has an automatic gearbox, place the selector lever in position P. Wait for the engine to cool down.
- Never open the bonnet if you see steam or drips of coolant being released from the engine compartment. Wait until no steam or coolant can be seen before opening the bonnet.
- Keep children away from the engine compartment.
- Never spill liquids used for vehicle operation on the engine compartment, as these may catch fire (e.g. the antifreeze in coolant).
- Avoid causing short-circuits in the electrical system, particularly at the points where the jump leads are attached >>> page 46. The battery could explode.
- If working inside the engine compartment, remember that, even when the igni-

tion is switched off, the radiator fan may start up automatically, and therefore there is a risk of injury.

- Never cover the engine with additional insulating materials such as a blanket. Risk of fire!
- Do not unscrew the cap on the coolant expansion tank when the engine is hot. The cooling system is under pressure.
- Protect face, hands and arms by covering the cap with a large, thick rag to protect against escaping coolant and steam.
- Always make sure you have not left any objects, such as cleaning cloths or tools, in the engine compartment.
- If you have to work underneath the vehicle, you must use suitable stands additionally to support the vehicle, there is a risk of accident! A hydraulic jack is insufficient for securing the vehicle and there is a risk of injury.
- If any work has to be performed when the engine is started or with the engine running, there is an additional, potentially fatal, safety risk from the rotating parts, such as the drive belts, alternator, radiator fan, etc., and from the high-voltage ignition system. You should also observe the following:
  - Never touch the electrical wiring of the ignition system.
  - Ensure that jewellery, loose clothing and long hair do not get trapped in rotating engine parts. Danger of death.

Before starting any work remove jewellery, tie back and cover hair, and wear tight-fitting clothes.

- Never accelerate with a gear engaged without taking the necessary precautions. The vehicle could move, even if the handbrake is applied. Danger of death.
- Observe the following additional warnings if work on the fuel system or the electrical system is necessary:
  - Always disconnect the battery from the on-board network.
  - Do not smoke.
  - Never work near naked flames.
  - Always keep an approved fire extinguisher immediately available.

### For the sake of the environment

- Inspect the ground underneath your vehicle regularly so that any leaks are detected at an early stage. If you find spots of oil or other fluids in the area where it was parked, have your vehicle inspected at the workshop.
- Service fluids leaks are harmful to the environment. For this reason you should make regular checks on the ground underneath your vehicle. If you find spots of oil or other fluids, have your vehicle inspected in a specialised workshop. >>>

### Note

In right-hand drive vehicles\* some brake fluid reservoirs are on the other side of the engine compartment»» Fig. 256.

## Opening and closing the bonnet

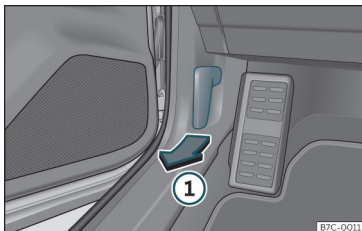

Fig. 254 Release lever in the driver's footwell area.

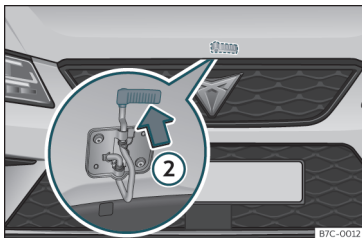

Fig. 255 Cam under the bonnet

### Opening the bonnet

The bonnet is released from inside the vehicle.

Before opening the bonnet, make sure that the windscreen wiper arms are in place against the windscreen.

- Open the door and pull the lever under the dashboard »» Fig. 254 ①.
- To lift the bonnet, press the release catch under the bonnet upwards »» Fig. 255 ②. The arrester hook under the bonnet is released.
- The bonnet can be opened. Release the bonnet stay and secure it in the fixture designed for this in the bonnet.

### Closing the bonnet

- Slightly lift the bonnet.
- Release the bonnet stay and replace it in its support.
- At a height of approximately 30 cm let it fall so it locks.

If the bonnet does not close, do not press downwards. Open it again and let it fall as mentioned above.

### WARNING

Make sure that the bonnet is properly closed. If it opens when driving, it can cause an accident.

### CAUTION

To avoid damage to the bonnet and to the windscreen wiper arms, only open it when the windscreen wipers are in place against the windscreen.



### Checking levels

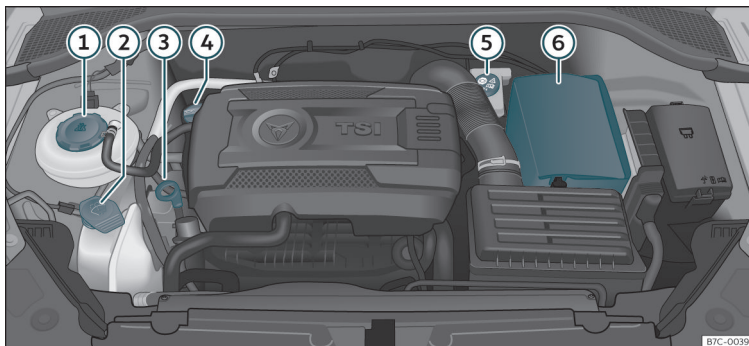

**Fig. 256** Diagram for the location of the various elements.

From time to time, the levels of the different fluids in the vehicle must be checked. Never fill with incorrect fluids, otherwise serious damage to the engine may be caused.

- ① Coolant expansion tank >>> page 322
- ② Windscreen washer reservoir >>> page 325
- ③ Engine oil level dipstick >>> page 320
- ④ Engine oil filler cap >>> page 321
- ⑤ Brake fluid reservoir >>> page 324
- ⑥ Vehicle battery (underneath a cover) >>> page 326

#### Note

The layout of parts may vary depending on the engine.

## Engine oil

### General notes

The engine comes with a special, multi-grade oil that can be used all year round.

Because the use of high-quality oil is essential for the correct operation of the engine and its long useful life, when topping up or

changing oil, use only those oils that comply with VW standards.

We recommend that the oil change be done by a technical service or specialised workshop.

#### If the engine oil level is too low

You can get information about the correct engine oil for your vehicle at your workshop.

If the recommended engine oil is not available, in the event of an **emergency** you can change the oil **once** with a maximum of 0.5 L of the next oil until the next oil change: »

- *Petrol engines:* standard VW 504 00, VW 502 00, VW 508 00, ACEA C3 or API SN.

Have the oil changed by a specialised workshop.

**Castrol** *EDGE* PROFESSIONAL

**Recommended by CUPRA**

CUPRA recommends using original SEAT oil to guarantee high performance of CUPRA engines.

### Engine oil additives

No type of additive should be mixed with the engine oil. The deterioration caused by these additives is not covered by the warranty.

#### **i** Note

**Before a long trip, we recommend finding an engine oil that conforms to the corresponding VW specifications and recommend keeping it in the vehicle. This way, the correct engine oil will always be available for a top-up if needed.**

### Warning lamp

#### It lights up red

 **Do not carry on driving!**  
Engine oil pressure too low.  
Switch off the engine. Check the engine oil level.

If this warning lamp  starts to flash, and is accompanied by three **audible warnings**, switch off the engine and check the oil level. If necessary, add more oil >>> page 321.

If the warning lamp  flashes although the oil level is correct, **stop driving**. Do not even run the engine at idle speed! Obtain technical assistance.

#### It lights up yellow

Check the engine oil level as soon as possible.  
Replace oil as soon as you have the opportunity to do so >>> page 321.

#### It flashes yellow

Fault in the oil level sensor.  
Have the check done by a specialised workshop. Until then it is advisable to check the oil level every time you refuel.

#### **WARNING**

**Observe the safety warnings >>>  in Control and warning lamps on page 79.**

### Checking the engine oil level

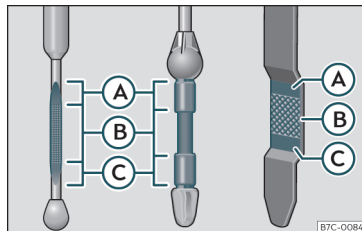

**Fig. 257** Engine oil dipstick.

The engine oil dipstick indicates the level of the oil.

#### Checking oil level

- Park the vehicle in a horizontal position.
- Briefly run the engine at idle speed until the operating temperature is reached and then stop.
- Wait for about two minutes.
- Pull out the dipstick. Wipe the dipstick with a clean cloth and insert it again, pushing it in as far as it will go.
- Then pull it out once more and check the oil level >>> **Fig. 257**. Top up with engine oil if necessary.

The oil must leave a mark between zones **(A)** and **(C)**. It can never go above zone **(A)**.

- Zone **(A)**: do not add oil.
- Zone **(B)**: you can add oil but keep the level in that zone.
- Zone **(C)**: add oil until zone **(B)**.

Depending on how you drive and the conditions in which the vehicle is used, oil consumption can be up to 0.5 l/1000 km. Oil consumption is likely to be higher for the first 5,000 km. For this reason the engine oil level must be checked at regular intervals, preferably when filling the tank and before a journey.

### **⚠ WARNING**

Any work carried out in the engine compartment or on the engine must be carried out cautiously.

- When working in the engine compartment, always observe the safety warnings >>> page 316.

### **ⓘ CAUTION**

If the oil level is above area **(A)**, do not start the engine. This could result in damage to the engine and catalytic converter. Contact a Technical Service.

### Topping up the engine oil

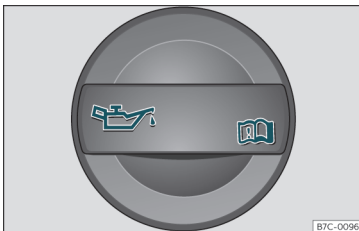

**Fig. 258** In the engine compartment: Engine oil filler cap.

Before opening the bonnet, read and observe the warnings >>> **⚠** in Working in the engine compartment on page 317.

### Topping up engine oil

- Unscrew cap from engine oil filler opening >>> **Fig. 258**.
- Carefully add oil in small quantities (no more than 0.5 l).
- To avoid adding too much oil, whenever you add a certain amount, wait about 2 minutes and recheck the oil level >>> page 320.
- If necessary, add some more oil.
- When the oil level reaches at least zone >>> **Fig. 257 (B)**, unscrew the engine oil filler cap carefully >>> **ⓘ**.

The position of the oil filler opening is shown in the corresponding engine compartment illustration >>> page 319.

Engine oil specification >>> page 319.

### **⚠ WARNING**

Oil is highly inflammable! Ensure that no oil comes into contact with hot engine components when topping up.

### **ⓘ CAUTION**

If the oil level is above area >>> **Fig. 257 (A)**, do not start the engine. This could result in damage to the engine and catalytic converter. Contact a specialised workshop.

### **🌿 For the sake of the environment**

The oil level must never be above zone >>> **Fig. 257 (A)**. Otherwise oil can be drawn in through the crankcase breather and leak into the atmosphere via the exhaust system.

### **ⓘ Note**

Before a long trip, we recommend finding an engine oil that conforms to the corresponding VW specifications and recommend keeping it in the vehicle. This way, the correct engine oil will always be available for a top-up if needed.

### Engine oil change

We recommend that you have the engine oil changed by a Technical Service.

#### WARNING

Only change the engine oil yourself if you have the specialist knowledge required!

- Before opening the bonnet, read and observe the warnings » page 316.
- Wait for the engine to cool down. Hot oil may cause burn injuries.
- Wear eye protection to avoid injuries, such as acid burns, caused by splashes of oil.
- When removing the oil drain plug with your fingers, keep your arm horizontal to help prevent oil from running down your arm.
- Wash your skin thoroughly if it comes into contact with engine oil.
- Engine oil is poisonous! Used oil must be stored in a safe place out of the reach of children.

#### CAUTION

No additives should be used with engine oil. This could result in engine damage. Any damage caused by the use of such additives would not be covered by the factory warranty.

#### For the sake of the environment

- We recommend that you change the engine oil and the filter at a technical service centre.
- Never pour oil down drains or into the ground.
- Use a suitable container when draining the used oil. It must be large enough to hold all the engine oil.

## Cooling system

### Coolant specifications

The engine cooling system is supplied from the factory with a specially treated mixture of water and at least 40 % of the additive **G12evo** (TL-VW 774 J), purple. This mixture gives the necessary frost protection down to -25°C (-13°F) and protects the light alloy parts of the engine cooling system against corrosion. It also prevents scaling and considerably raises the boiling point of the coolant.

To protect the cooling system, the percentage of additive must always be at least 40 %, even in warm climates where anti-freeze protection is not required.

If for weather reasons further protection is necessary, the proportion of additive may be

increased, but only up to 60 %; otherwise antifreeze protection will diminish and this will worsen cooling.

When the coolant is topped up, use a mixture of **distilled water** and at least 40 % of the additive **G12evo** for optimal protection against corrosion. Mixing **G12evo** with G13 (TL-VW 774 J), G12 plus-plus (TL-VW 774 G), G12 plus (TL-VW 774 F), G12 (red) or G11 (green blue) engine coolants decreases protection against corrosion and should be avoided.

#### WARNING

If there is not enough anti-freeze in the coolant system, the engine may fail leading to serious damage.

- Ensure that the percentage of additive is correct for the lowest expected ambient temperature in the zone in which the vehicle is to be used.
- When the outside temperature is very low, the coolant could freeze and the vehicle would be immobilised.

#### CAUTION

The original additives should never be mixed with coolants which are not approved by SEAT.

- If the fluid in the expansion tank is not purple but is, for example, brown, this indicates that the **G12evo** additive has been

mixed with an inadequate coolant. The coolant must be changed as soon as possible if this is the case!

### For the sake of the environment

Coolants and additives can contaminate the environment. If any fluids are spilled, they should be collected and correctly disposed of, with respect to the environment.

### Refilling coolant

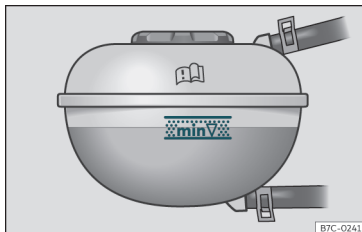

**Fig. 259** In the engine compartment: marking on coolant expansion tank.



**Fig. 260** Engine compartment: coolant expansion tank cap.

The coolant tank is located in the engine compartment >>> page 319.

Top up coolant when the level is below the **MIN** (minimum) mark.

#### Checking coolant level

- Park the vehicle in a horizontal position.
- Switch the ignition off.
- Read off the coolant level on coolant expansion tank. When the engine is cold, the coolant level should be between the marks >>> **Fig. 259**. When the engine is hot, it may be slightly above the upper mark.

#### Topping up coolant

- Wait for the engine to cool down.

- Cover the coolant expansion tank cap with a cloth and carefully unscrew it to the left >>> .

- Top up the coolant only if there is still coolant in the expansion tank, otherwise you could **damage the engine**. If there is no coolant in the expansion tank, do not continue driving. You should obtain professional assistance >>> .

- If there is still some coolant in the expansion tank, top up to the upper mark.

- Top up with coolant until the level becomes stable.

- Screw the cap back on correctly.

If there is a coolant leak, take the vehicle specialised workshop to have the cooling system examined.

#### **WARNING**

- The cooling system is under pressure. Do not unscrew the cap on the coolant expansion tank when the engine is hot: risk of burns!
- Store the antifreeze in its original container and keep it out of reach of children.
- If working inside the engine compartment, remember that, even when the ignition is switched off, the radiator fan may start up automatically, and therefore there is a risk of injury. >>>

**ⓘ CAUTION**

If you run out of coolant in the expansion tank, park the car in a safe place and do not continue driving. Obtain technical assistance.

## Brake fluid

### Check and refill the brake fluid



**Fig. 261** Engine compartment: brake fluid reservoir cap.

The brake fluid reservoir is located in the engine compartment >>> page 319.

### Checking the brake fluid level

The brake fluid level must be between the **MIN** and **MAX** markings.

However, if the brake fluid level goes down noticeably in a short time, or drops below the **MIN** mark, there may be a leak in the brake system. Seek specialist assistance. A warning light on the instrument panel display monitors the brake fluid level >>> page 77.

In right-hand drive vehicles the brake fluid reservoir is on the other side of the engine compartment.

### Changing brake fluid

We recommend that you have the brake fluid changed by a Technical Service.

**⚠ WARNING**

If the brake fluid level is low or unsuitable/old brake fluid is used, the brake system may fail or braking power may be reduced.

- Check the brake system and the brake fluid level regularly!
- When the brake fluid is used and brakes are subjected to extreme braking forces, bubbles of vapour form in the brake system. These bubbles can significantly reduce braking power, notably increasing braking distance, and could result in the total failure of the brake system.
- Be sure to always use the correct brake fluid. Only use brake fluid that expressly meets the VW 501 14 standard.

- You can buy VW 501 14 standard brake fluid at a specialised CUPRA service or at a SEAT Official Service. If none is available, use only high-quality brake fluid that meets DIN ISO 4925 CLASS 4 standards, or USA Standards FMVSS 116 DOT 4.

- The replacement brake fluid must be new.
- Brake fluid should be stored in the closed original container in a safe place out of reach of children. Risk of poisoning!

**ⓘ CAUTION**

Brake fluid should not come into contact with the vehicle paintwork, as it is abrasive.

**♻ For the sake of the environment**

Brake fluid is an environmental pollutant. Collect any spilt service fluids and allow a professional to dispose of them.

### Windscreen washer reservoir

#### Checking the level of the window washer tank and refilling it

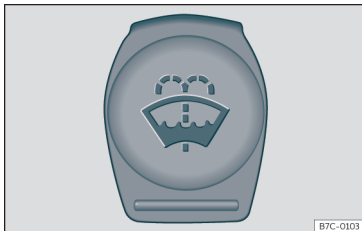



**Fig. 262** In the engine compartment: window washer tank cap.

The window washer tank is in the engine compartment >>> page 319.

Check the water level in the windscreen washer reservoir regularly and top up as required.

The container for the windscreen washer contains the cleaning fluid for the windscreen, the rear window and the headlight washer system\*.

- Open the bonnet  >>> page 316.
- The window washer tank is marked with the  symbol on the cap.

- Check there is enough windscreen water in the reservoir.

Plain water is not enough to clean the windscreen and headlights. We recommend that you always add a product to the windscreen washer fluid.

#### Recommended windscreen wipers

- For the hottest seasons we recommend summer G 052 184 A1 for clear glass. Proportions of the mixture in the washer fluid tank: 1:100 (1 part concentrate per 100 parts water).
- All year round, G 052 164 A2 for clear glass. Approximate proportion of the winter mixture, up to  $-18^{\circ}\text{C}$  ( $0^{\circ}\text{F}$ ): 1:2 (1 part concentrate per 2 parts water); otherwise, a 1:4 proportion of mixture in the washer fluid tank.

The capacity of the window washer tank can be found in >>> page 355.

#### CAUTION

If the water from the windscreen washer does not contain enough anti-freeze, it may freeze on the windscreen and rear window, reducing forward and rear visibility.

- In winter, ensure the windscreen washer contains enough anti-freeze.
- In cold conditions, you should not use the windscreen wiper system unless you have

warmed the windscreen with the ventilation system. The antifreeze could freeze on the windscreen and reduce visibility.

#### CAUTION

Never mix an unsuitable antifreeze or other similar additives with the windscreen washer water. A greasy layer may be formed on the windscreen which will impair visibility.

- Use clean water with a window cleaner recommended by CUPRA.
- If necessary, add a suitable antifreeze to the water in the reservoir.

#### CAUTION

Do not mix cleaning products recommended by CUPRA with other products. This could lead to flocculation and may block the windscreen washer jets.

- When topping up service fluids, make absolutely certain that you fill the fluids into the correct reservoirs. Using the wrong fluids could cause serious malfunctions and engine damage!
- Not having windscreen wiper fluid reduces visibility through the windscreen, and leads to loss of visibility in headlights in models with headlight washer.

## Battery

### General information

The battery is located in the engine compartment and is almost **maintenance-free**. It is checked as part of the Inspection Service. Nevertheless, check the terminals are clean and have the correct tightening torque, especially in summer and winter.

All work on batteries requires specialist knowledge. Please refer to a specialised CU-PRA Service, SEAT Official Service or a workshop specialising in batteries: risk of burns or exploding battery!

**The battery must not be opened.** Never try to change the fluid level of the battery. Otherwise explosive gas is released from the battery that could cause an explosion.

### Battery warning indications



Wear eye protection.



Battery acid is extremely corrosive. Wear protective gloves and eye protection. Rinse any splashes of electrolyte with plenty of water.



Fires, sparks, open flames and smoking are prohibited.



The battery should only be charged in a well-ventilated zone. Risk of explosion!



Keep children away from acid and batteries!

### Disconnecting the battery

The battery should only be disconnected in exceptional cases. When the battery is disconnected, some of the vehicle's functions are lost. These functions will require resetting after the battery is reconnected.

When disconnecting the battery from the vehicle on-board network, disconnect first the negative cable and then the positive cable.

Deactivate the anti-theft alarm\* before you disconnect the battery. Otherwise the alarm will be triggered.

### If the vehicle is not used for long periods

The vehicle has a system for monitoring the current consumption when the engine is left unused for long periods of time >>> page 328. Some functions, such as the interior lights, or the remote door opening, may be temporarily disabled to prevent the battery from running flat. These functions will come back on as soon as the ignition is switched on and the engine started.

### Winter conditions

During the winter, the starting power may be reduced, and if necessary, the battery should be charged >>>



### WARNING

Always be aware of the danger of injury and chemical burns as well as the risk of accident or fire when working on the battery and the electrical system:

- Wear eye protection. Protect your eyes, skin and clothing from acid and particles containing lead.
- Battery acid is extremely corrosive. Wear protective gloves and eye protection. Do not tilt the batteries. This could spill acid through the vents.
- Neutralise any electrolyte splashes on the skin, eyes or clothing with a soapy solution, and rinse off with plenty of water. If acid is swallowed by mistake, consult a doctor immediately.
- Fires, sparks, open flames and smoking are prohibited. When handling cables and electrical equipment, avoid causing sparks and electrostatic charge. Never short the battery terminals. High-energy sparks can cause injury.
- A highly explosive mixture of gases is released when the battery is under charge. The batteries should be charged in a well-ventilated room only.
- Keep children away from acid and batteries.
- Before working on the electrical system, you must switch off the engine, the ignition and all electrical devices. The negative cable on the battery must be disconnected.



When a light bulb is changed, you need only switch off the light.

- Deactivate the anti-theft alarm by unlocking the vehicle before you disconnect the battery! The alarm will otherwise be triggered.
- When disconnecting the battery from the vehicle on-board network, disconnect first the negative cable and then the positive cable.
- Switch off all electrical devices before reconnecting the battery. Reconnect first the positive cable and then the negative cable. Never reverse the polarity of the connections. This could cause an electrical fire.
- Never charge a frozen battery, or one which has thawed. This could result in explosions and chemical burns. Always replace a battery which has frozen. A flat battery can also freeze at temperatures close to 0°C (+32°F).
- Ensure that the vent hose is always connected to the battery.
- Never use a defective battery. This could cause an explosion. Replace a damaged battery immediately.

### ⓘ CAUTION

- Do not expose the battery to direct sunlight over a long period of time, as the intense ultraviolet radiation can damage the battery housing.

- If the vehicle is left standing in cold conditions for a long period, protect the battery from “freezing”. If it freezes it will be damaged.

### Warning lamp

#### It lights up

Alternator fault.

The control lamp lights up when the ignition is switched on. It should go out when the engine has started running.

If the control lamp  lights up while driving, the alternator is no longer charging the battery. You should immediately drive to the nearest specialised workshop.

You should avoid using electrical equipment that is not absolutely necessary because this will drain the battery.

### Checking the battery electrolyte level

The electrolyte level should be checked regularly in high-mileage vehicles, in hot countries and in older batteries.

- Open the bonnet and then lift the cover that protects the front part of the battery

»  in Working in the engine compartment on page 317.

- Check the colour display in the “magic eye” on the top of the battery.
- If there are air bubbles in the window, tap the window gently until they disperse.

The position of the battery is shown in the corresponding engine compartment diagram » page 319.

The “magic eye” indicator, located on the top of the battery changes colour, depending on the charge state and electrolyte level of the battery.

There are two different colours:

- Black: correct charge status.
- Transparent/light yellow: the battery must be replaced. Contact a specialised workshop.

### Charging or changing the battery

If you often drive short distances or if the vehicle is not driven for long periods, the battery should be checked by a specialised workshop between the scheduled services.

If the battery has discharged and you have problems starting the vehicle, the battery might be damaged. If this happens, we recommend you have the vehicle battery

»

checked by a Technical Service where it will be re-charged or replaced.

### Charging the battery

The vehicle battery should be charged by a specialised workshop only, as batteries using special technology have been installed and they must be charged in a controlled environment.

### Replacing a vehicle battery

The battery has been developed to suit the conditions of its location and has special safety features. If the battery must be replaced, consult a technical service for information on electromagnetic compatibility, the size and maintenance, performance and safety requirements of the new battery in your vehicle before you purchase one. CU-PRA recommends you have the battery replaced by a technical service.

Start-Stop systems (»» page 230) are equipped with a special battery. Therefore, it must only be replaced with a battery of the same specifications.

Your vehicle is equipped with an intelligent power management system to control the distribution of electrical energy »» page 328. The power management function ensures that the battery is charged much more efficiently than on vehicles without a power management system. To maintain this func-

tion after replacing the battery, we recommend that the replacement battery used is of the same make and type as the original fitted battery. To make proper use of the power management function after the battery has been changed, have the battery coded to the power management mode at a specialised workshop.

#### WARNING

- Always use only maintenance free batteries that do not run flat alone and whose properties, specifications and size correspond to the standard battery. The specifications are indicated on the battery case.
- Before starting any work on the batteries, you must read and observe the warnings »»  in General information on page 326.

#### For the sake of the environment

 Batteries contain toxic substances such as sulphuric acid and lead. They must be disposed of appropriately and must not be disposed of with ordinary household waste.

## Energy management

### Optimisation of the starting capacity

The power management controls the distribution of electrical energy and thus helps to

ensure that there is always enough power available to start the engine.

If a vehicle with a conventional electrical system is left parked for a long time, the battery will gradually lose its charge because certain electrical devices, such as the electronic gearbox lock continues to draw current even when the ignition is off. In some cases there may not be enough power available to start the engine.

Your vehicle is equipped with an intelligent power management system to control the distribution of electrical energy. This significantly improves reliability when starting the engine, and also prolongs the useful life of the battery.

The main functions incorporated in the power management system are **battery diagnosis, residual current management** and **dynamic power management**.

### Battery diagnosis

The battery diagnosis function constantly registers the condition of the battery. Sensors detect the battery voltage, battery current and battery temperature. This enables the system to calculate the current power level and charge condition of the battery.

### Residual current management

The residual current management reduces power consumption while the vehicle is

parked. It controls the supply of power to the various electrical devices while the ignition is switched off. The system takes the battery diagnosis data into consideration.

Depending on the power level of the battery, switch off the individual electrical devices one after the other to prevent the battery from losing too much charge and to ensure that the engine can be started reliably.

### Dynamic power management

While the vehicle is moving, this function distributes the available power to the various electrical devices and systems according to their requirements. The power management ensures that on-board systems do not consume more electrical power than the alternator can supply, and thus maintains the maximum possible battery power level.

#### Note

- **Neither is the power management system able to overcome the given physical limits. Please remember that the power and useful life of the battery are limited.**
- **When there is a risk that the vehicle will not start, the alternator power failure or low battery charge level warning lamp will be shown  >>> page 77.**

### Flat battery

Starting ability has first priority.

Short trips, city traffic and low temperatures all place a heavy load on the battery. In these conditions a large amount of power is consumed, but only a small amount is supplied. The situation is also critical if electrical devices are in use when the engine is not running. In this case power is consumed when none is being generated.

In these situations you will be aware that the power management system is intervening to control the distribution of electrical power.

### When the vehicle is parked for long periods

If you do not drive your vehicle for a period of several days or weeks, the power management will gradually shut off the electrical devices one by one or reduce the amount of current they are using. This limits the amount of power consumed and helps to ensure reliable starting even after a long period. Some convenience functions, such as remote vehicle opening, may not be available under certain circumstances. These functions will be restored when you switch on the ignition and start the engine.

### With the engine switched off

For example, if you listen to the sound system with the engine switched off the battery will run down.

If the energy consumption means there is a risk that the engine will not start, a text will appear in vehicles with a driver information system\*.

This driver indicator tells you that you must start the engine so that the battery can recharge.

### When the engine is running

Although the alternator generates electrical power, the battery can still become discharged while the vehicle is being driven. This can occur when a lot of power is being consumed but only a small amount supplied, especially if the battery is not fully charged initially.

To restore the necessary energy balance, the system will then temporarily shut off the electrical devices that are using a lot of power, or reduce the current they are consuming. Heating systems in particular use a large amount of electrical power. If you notice, for instance, that the seat heating\* or the rear window heater is not working, they may have been temporarily switched off or regulated to a lower heat output. These systems will be available again as soon as sufficient electrical power is available. »

You may also notice that the engine runs at a slightly faster idling speed when necessary. This is quite normal, and no cause for concern. The increased idling speed allows the alternator to meet the greater power requirement and charge the battery at the same time.

## Wheels

### Wheels and tyres

#### General notes

- When driving with **new tyres**, be especially careful during the first 500 km (300 miles).
- If you have to drive over a kerb or similar obstacle, drive very slowly and as near as possible at a right angle to the obstacle.
- Check from time to time if the tyres are damaged (punctures, cuts, cracks or dents). Remove any foreign objects embedded in the treads.
- Damaged wheels and tyres must be replaced immediately.
- Keep grease, oil and fuel off the tyres.
- Replace any missing valve caps as soon as possible.
- Mark the wheels before taking them off so that they rotate in the same direction when put back.
- When removed, the wheels or tyres should be stored in a cool, dry and preferably dark place.

#### Low profile tyres

Low profile tyres have a wider tread, a larger wheel diameter and a lower sidewall height. Therefore, its driving behaviour is more agile.

Low profile tyres may deteriorate more quickly than standard tyres, for instance due to strong knocks, potholes, manhole covers and kerbs. Correct tyre pressure is very important »» page 333.

To avoid damage to tyres and wheels, drive with special care when driving on roads in poor condition.

Visually check your wheels every 3000 km.

If the tyres or rims have received a heavy impact or have been damaged, have a specialised workshop check whether or not it is necessary to change the tyre.

Low profile tyres may deteriorate more quickly than standard tyres.

#### Concealed damage

Damage to tyres and rims is often not readily visible. If you notice unusual **vibration** or the car **pulling to one side**, this may indicate that one of the tyres is damaged. Reduce speed immediately if there is any reason to suspect that damage may have occurred. Inspect the tyres for damage. If no external damage is visible, drive slowly and carefully to the nearest specialised workshop and have the car inspected.

### Foreign objects inserted in the tyre

- Do not remove foreign bodies if they have penetrated through the tyre wall!
- If the vehicle comes with a tyre mobility system, where necessary seal the damaged tyre as shown in section >>> page 38. Use a specialised workshop for repair or replacement. To do so, CUPRA recommends going to a specialised CUPRA dealer or any SEAT dealership.

The sealant at the lower part of the tyre tread wraps around the foreign body and provisionally seals the tyre.

### Tyres with directional tread pattern

An arrow on the tyre sidewall indicates the direction of rotation on single drive tyres. Always note the direction of rotation indicated when mounting the wheel. This makes sure that optimal use is made of tyre properties in terms of aquaplaning, grip, excessive noise and wear.

### Subsequent fitting of accessories

If you wish to change or fit wheels, rims or wheel trims, we recommend that you consult with a specialised CUPRA Service or SEAT Official Service centre for advice regarding current technical recommendations.

### Speed symbols

The speed rating indicates the maximum speed permitted for the tyres.

P	max. 150 km/h (93 mph)
Q	max. 160 km/h (99 mph)
R	max. 170 km/h (106 mph)
S	max. 180 km/h (112 mph)
T	max. 190 km/h (118 mph)
U	max. 200 km/h (124 mph)
H	max. 210 km/h (130 mph)
V	max. 240 km/h (149 mph)
Z	max. 240 km/h (149 mph)
W	max. 270 km/h (168 mph)
Y	max. 300 km/h (186 mph)

Some manufacturers use the letters "ZR" for tyres with a maximum authorised speed above 240 km/h (149 mph).

#### WARNING

- New tyres do not have maximum grip during the first 500 km. Drive particularly carefully to avoid possible accidents.
- Never drive with damaged tyres. This may cause an accident.
- If you notice unusual vibrations or if the vehicle pulls to one side when driving, stop

the vehicle immediately and check the tyres.

- Never use old tyres or those with an unknown history of use.

### New wheels and tyres

It is best to have all wheels and tyres serviced by a specialised workshop. There they have the required knowledge, the special tools and the corresponding spare parts.

- Even winter tyres lose their grip on ice. If you have installed new tyres, drive the first 500 km carefully and at a moderate speed.
- All four wheels must be fitted with tyres of the same type, size (rolling circumference) and, if possible, tread pattern.
- When changing tyres, do not change just one; change at least two on the same axle.
- If you want to equip your vehicle with a combination tyres and rims that are different to those fitted in the factory, inform your specialised workshop before purchasing them >>> 

The sizes of the rims and tyres approved for your vehicle are listed in the vehicle documentation (e.g. EC Certificate of Conformity) >>

or COC document<sup>1)</sup>). The vehicle documentation varies depending on the country of residence.

If the type of spare wheel is different from the normal wheels — e.g. in the case of winter tyres or particularly wide tyres — the spare wheel should only be used temporarily in the event of a puncture, and the vehicle should be driven with care. Refit the normal road wheel as soon as possible.

In vehicles with four-wheel drive, the 4 wheels must be fitted with tyres of the same brand, type and tread so that the traction system is not damaged by a difference in the number of turns of the wheels. Therefore, in the event of a puncture, only a spare wheel with the same perimeter as normal tyres should be used.

#### Manufacturing date

The manufacturing date is also indicated on the tyre sidewall (or on the inside face of the wheel):

**DOT ... 2218 ...**

it means, for example, that the tyre was manufactured in the 22nd week of 2018.

#### WARNING

- Use only combinations of tyres and rims, as well as suitable wheel nuts, approved by CUPRA. Otherwise the vehicle may be damaged, causing an accident.
- For technical reasons it is not possible to use wheels of other vehicles; in some cases not even wheels from the same vehicle model should be used.
- Always ensure that the tyres you have chosen have adequate clearance. When selecting replacement tyres, do not rely entirely on the nominal tyre size marked on the tyre, since the nominal tyre size can differ significantly depending on the manufacturer. Lack of clearance can damage the tyres or the vehicle and, as a result, endanger road safety. Risk of accident!
- Only use tyres that are over 6 years old in an emergency, and drive with due care.
- The fitting of tyres with run-flat properties is not permitted on your vehicle! Prohibited use can cause accidents or can damage your vehicle.
- If decorative hubcaps are subsequently fitted, make sure that they allow enough air in to cool the braking system. Risk of accident!

#### For the sake of the environment

Old tyres must be disposed of according to the laws in the country concerned.

#### Note

- A CUPRA Service Centre should be consulted to find out whether wheels or tyres of different sizes to those originally fitted by CUPRA can be fitted, and to find out about the combinations allowed between the front axle (axle 1) and the rear axle (axle 2).
- Never mount used tyres if you are not sure of their “previous history”.
- When 245/40 R19 tyres are outfitted, the corresponding reflector must also be installed.

<sup>1)</sup> COC = certificate of conformity.

## Tyre life

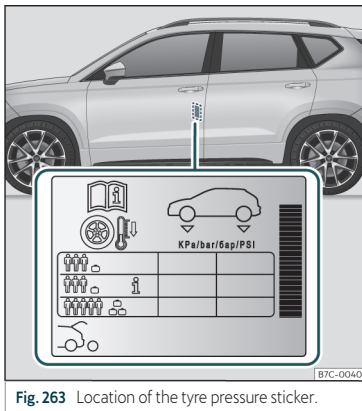

Fig. 263 Location of the tyre pressure sticker.

Correct inflation pressures and sensible driving habits will increase the useful life of your tyres.

- Check tyre pressure at least once a month, and also prior to any long trip.
- The tyre pressure should only be checked when the tyres are *cold*. Do not reduce the pressure of warm tyres.
- Adjust tyre pressure to the load being carried by the vehicle >>> Fig. 263.
- In vehicles with a tyre pressure indicator, save the modified tyre pressure >>> page 337.

- Avoid fast cornering and hard acceleration.
- Inspect the tyres for irregular wear from time to time.

## Tyre pressure

The tyre inflation pressures are listed on a sticker on the rear of the front left door frame >>> Fig. 263.

Insufficient or excessive pressure greatly reduces the useful life of the tyres and adversely affects vehicle performance and ride. Correct inflation pressures are very important, especially at **high speeds**.

Depending on the vehicle, tyre pressure can be adjusted to medium load to improve driving comfort (tyre pressure **i**) >>> Fig. 263). When driving with comfort tyre pressure fuel consumption may increase slightly.

The tyre pressure must be adjusted according to the load the vehicle is carrying. If the vehicle is going to carry the maximum load, the tyre pressure should be increased to the maximum value indicated on the sticker >>> Fig. 263.

Do not forget the spare wheel when checking the tyre pressures: Keep this spare wheel inflated to the highest pressure required for the road wheels.

In the case of a minimised temporary spare wheel (125/70 R18) inflate to a pressure of

4.2 bar as indicated on the tyre pressure label >>> Fig. 263.

## Driving style

Fast cornering, heavy acceleration and hard braking (squealing tyres) all increase tyre wear.

## Wheel balance

The wheels on new vehicles are balanced. However, certain circumstances may lead to imbalance (run-out), which is detected as vibrations in the steering wheel.

Unbalanced wheels should be rebalanced, as they otherwise cause excessive wear on steering, suspension and tyres. A wheel must also be rebalanced when a new tyre is fitted or if a tyre is repaired.

## Incorrect wheel alignment

Incorrect running gear alignment causes excessive tyre wear, impairing the safety of the vehicle. If you notice excessive tyre wear, you should check wheel alignment at a specialised CUPRA Service or SEAT Official Service.

**⚠ WARNING**

Unsuitable handling of the wheels and tyres may lead to sudden tyre pressure losses, to tread separation or even to a blow-out. »

- The driver is responsible for ensuring that all of the vehicle tyres are correctly inflated to the right pressure. The recommended tyre pressure is indicated on the label >>> Fig. 263.
- Check tyre pressures regularly and ensure they are maintained at the pressures indicated. Tyre pressure that is too low could cause overheating, resulting in tread detachment or even burst tyres.
- When the tyres are cold, tyre pressure should be that indicated on the label >>> Fig. 263.
- Regularly check the cold inflation pressure of the tyres. If necessary, change the tyre pressure of the vehicle tyres while they are cold.
- Regularly check your tyres for damage and wear.
- Never exceed the maximum permitted speed or loads specified for the type of tyre fitted on your vehicle.

### For the sake of the environment

Under-inflated tyres will increase fuel consumption.

### Tread wear indicators

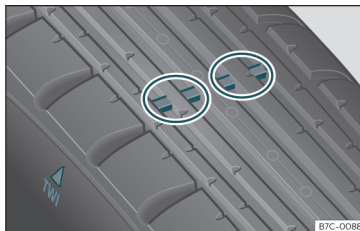

Fig. 264 Tyre profile: tread wear indicators.

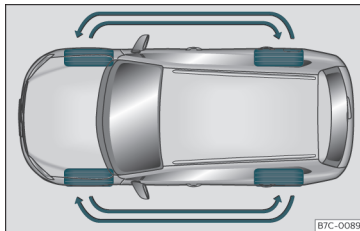



Fig. 265 Interchanging tyres.

Wear indicators around 1.6 mm high can be found on the base of the original tyre treads, ordered at regular intervals and running across the tread >>> Fig. 264. The letters

"TWI" or triangles on the sidewall of the tyre mark the position of the wear indicators.

The minimum permitted profile depth<sup>1)</sup> have been reached when the tyres have worn down to the wear indicators. Replace the tyres with new ones >>> .

### Changing wheels around

To ensure that the wear is equal on all tyres the wheels should be changed round from time to time according to the system >>> Fig. 265. The useful life of all the tyres will then be about the same time.

### WARNING

The tyres must be replaced at the latest when the tread is worn down to the tread wear indicators. Failure to follow this instruction could result in an accident.

- Particularly in difficult driving conditions such as wet or icy roads. It is important that the tyre tread be as deep as possible and be approximately the same on the tyres of both the front and the rear axles.
- The scant driving safety due to insufficient tread depth is particularly evident in vehicle handling, when there is a risk of "aquaplaning" in deep puddles of water

<sup>1)</sup> Follow the regulations of the country you are driving in.



and when driving through corners, and braking is also adversely affected.

- The speed has to be adapted accordingly, otherwise there is a risk of losing control over the vehicle.

## Wheel nuts

The **wheel nuts** are matched to the rims. When installing different wheels (for instance alloy wheels or wheels with winter tyres) it is important to use the correct wheel nuts with the right length and correctly shaped bolt heads. This ensures that wheels are fitted securely and that the brake system functions correctly.

The wheel nuts must be clean and turn easily.

A special adapter is required to turn the anti-theft wheel nuts\* >>> page 42.

### WARNING

Wheel nuts should never be greased or oiled.

- Use only wheel nuts which belong to the wheel.
- If the prescribed torque of the wheel nuts is too low, they could loosen whilst the ve-

hicle is in motion. Risk of accident! If the tightening torque is too high, the wheel nuts and threads can be damaged.

### CAUTION

See >>> page 44 to find out the recommended tightening torque for wheel nuts for steel and alloy rims.

## Winter tyres

- Winter tyres must be fitted **on all four** wheels.
- Only use winter tyres that are approved for your vehicle.
- Please note that the maximum permissible speed for winter tyres may be lower than for summer tyres.
- Also note that winter tyres are no longer effective when the **tread** is worn down.
- After fitting the wheels you must always check the tyre pressures. When doing so, take into account the correct tyre pressures listed on the rear of the front left door frame >>> page 333.

In winter road conditions winter tyres will considerably improve vehicle handling. The

design of summer tyres (width, rubber compound, tread pattern) gives less grip on ice and snow. This applies particularly to vehicles equipped with **wide section tyres** or with **high speed tyres** (code letters H, V or Y on the sidewall).

Only use winter tyres of the correct type approved for your vehicle. The sizes of these tyres are specified in the vehicle's documents (e.g. EC Certificate of Conformity or COC<sup>1)</sup>). The vehicle documentation varies depending on the country of residence.

Winter tyres lose a great deal of their properties when the **tread** is worn down to a depth of 4 mm.

The performance of winter tyres is also severely impaired by **ageing**, even if the tread is still much deeper than 4 mm.

A code letter indicating the speed limit is stamped on all winter tyres >>> page 331.

Vehicles capable of exceeding these speeds must have an appropriate **sticker** attached so that it is visible to the driver. Suitable stickers are available at specialised CUPRA Services, SEAT Official Service centres and specialised workshops. Please note the regulations to this effect in your country.

"All-weather" tyres can also be used instead of winter tyres. »

<sup>1)</sup> COC = certificate of conformity.

### Using winter tyres with V-rating

Please note that the generally applicable 240 km/h (149 mph) speed for winter tyres with the letter V is subject to **technical restrictions; the maximum permissible speed for your vehicle may be significantly lower**. The maximum speed limit for these tyres depends directly on the maximum axle weights for your car and on the listed weight rating of the tyres being used.

It is best to contact a specialised CUPRA Service or SEAT Official Service to check the maximum speed which is permissible for the V-rated tyres fitted on your car on the basis of this information.

#### WARNING

Exceeding the maximum speed permitted for the winter tyres fitted on your car can cause tyre failure, resulting in a loss of control of the vehicle – risk of accident.

#### For the sake of the environment

When winter is over, change back to summer tyres at an appropriate moment. In temperatures above +7°C (+45°F), performance will be improved if summer tyres are used. Fuel consumption, wear and noises while driving will all be reduced.

### Snow chains

Snow chains must only be fitted to the **front wheels**, even on vehicles with **four-wheel drive**.

- Check that they are correctly seated after driving for a few yards; correct the position if necessary, in accordance with the manufacturer's fitting instructions.
- Keep your speed below 50 km/h (30 mph).
- If there is a danger of being trapped despite having mounted the chains, it is best to disable the driving wheels (ASR) in the ESC >>> page 281, Connecting and disconnecting the ESC.

Snow chains will improve *braking ability* as well as *traction* in winter conditions.

For technical reasons snow chains may only be used with the following wheel rim/tyre combination.

225/50 R18	Chains with links of maximum 9 mm
225/45 R19	
Other dimensions do not allow chains	

Remove any central wheel trims and the rim ring before fitting snow chains.

#### WARNING

The use of unsuitable or incorrectly fitted chains could lead to serious accidents and damage.

- Always the appropriate snow chains.
- Observe the fitting instructions provided by the snow chain manufacturer.
- Never exceed the maximum permitted speeds when driving with snow chains.

#### CAUTION

- Remove the snow chains to drive on roads without snow. Otherwise they will impair vehicle handling, damage the tyres and wear out very quickly.
- Wheel rims may be damaged or scratched if the chains come into direct contact with them. CUPRA recommends the use of coated snow chains.

## Tyre pressure loss indicator

### Control lamp

#### It lights up

The inflation pressure of one or more wheels is much lower than the value set by the driver, or the tyre has structural damage.

In addition, an audible warning sounds and a text message is displayed on the instrument panel screen.

**Stop the vehicle!** Stop the vehicle safely as soon as possible. Check all tyres and pressures. Replace any damaged tyres.

#### Flashes

System fault

The control lamp flashes for approximately 1 minute and then lights up permanently.

If the tyre is inflated correctly, switch the ignition off and on again. Re-calibrate the tyre pressure loss indicator >>> page 337. If the fault continues, go to a specialised workshop.

Several control and warning lamps light up for a few seconds when the ignition is switched on while the function is verified. They will switch off after a few seconds.

### WARNING

Observe the safety warnings >>>  in Control and warning lamps on page 79.

### Tyre monitor system

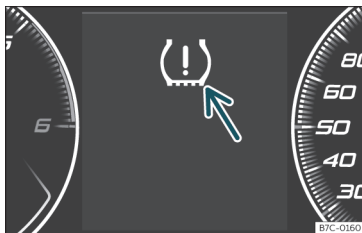



Fig. 266 Instrument panel: warning of loss of tyre pressure.

The tyre monitor indicator compares wheel revolutions and, with this information, the tread of each wheel using the ABS sensors.

If the rolling circumference of one or more wheels has changed, the tyre monitoring indicator will indicate this on the instrument panel through a warning lamp and a warning to the driver >>> Fig. 266. When only one specific tyre is affected, its position within the vehicle will be indicated.

 **Loss of pressure: Check left tyre pressure!**

### Wheel tread change

The wheel diameter changes when:

- Tyre pressure is changed manually.
- Tyre pressure is insufficient.

- The tyre structure is damaged.
- The vehicle is unbalanced because of a load.
- The wheels on an axle are subject to a heavier load (e.g. with a heavy load).
- The vehicle is fitted with snow chains.
- The temporary spare wheel is fitted.
- The wheel on one axle is changed.

There may be a delay in the reaction of the tyre  monitoring indicator or it may not indicate anything under certain circumstances (e.g. sporty driving, snow-covered or unpaved roads, or when driving with snow chains).

### Calibrating the tyre monitoring indicator

After changing the tyre pressure or replacing one or more wheels, the tyre monitoring indicator must be recalibrated. Do the same, for example, when the front and rear wheels are swapped.

- Switch the ignition on.
- Store the new tyre pressure in the Easy Connect system with the button  > **SETTINGS > Tyres** >>> page 80.

When driving, the system self-calibrates the tyre pressure provided by the driver and the wheels fitted. After a long journey with varied speeds the programmed values are collected and monitored. **>>**

With the wheels under very heavy loads, the tyre pressure must be increased to the total recommended tyre pressure before calibration >>> Fig. 263.

### WARNING

When the tyres are inflated at different pressures or at a pressure that is too low then a tyre may be damaged resulting in a loss of control of the vehicle and a serious or fatal accident.

- If the lamp () lights up, reduce speed immediately and avoid any sudden turning or braking manoeuvre. Stop when possible, and check the tyre pressure and status.
- The tyre monitoring system can only operate correctly if all of the tyres are inflated to the correct pressure when cold.
- If a tyre has not been punctured and it does not have to be changed immediately, drive to the nearest specialised workshop at a moderate speed and have the tyre checked and inflated to the correct pressure.

### Note

- Driving for the first time with new tyres at a high speed can cause them to slightly expand, which could then produce an air pressure warning.
- If excessively low tyre pressure is detected with the ignition on, an audible warning will sound. In the event that there is a fault

in the system, an audible warning will sound.

- Driving on dirt tracks for a long period of time or driving in a sporty style can temporarily deactivate the TPMS. The control lamp shows a fault, but disappears when road conditions or the driving style change.
- Do not only rely on the tyre monitoring system. Regularly check your tyres to ensure that the tyre pressure is correct and that the tyres are not damaged due to puncture, cuts, tears and impacts/dents. Remove objects from the tyres only when they have not pierced the tyres.
- The tyre monitoring indicator does not function when there is a fault in the ESC or ABS >>> page 279.

## Spare wheel

### Location and use of the temporary spare wheel

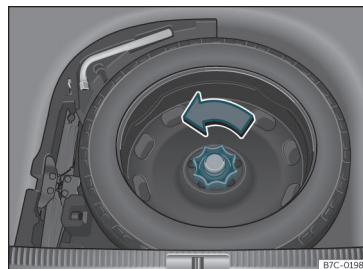

**Fig. 267** In the luggage compartment: load floor raised.

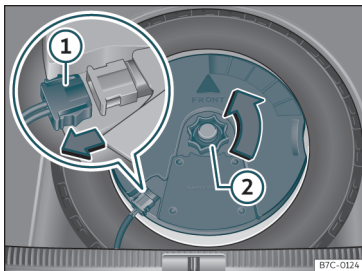

**Fig. 268** In the luggage compartment: remove the subwoofer.

The temporary spare wheel is stored under the floor panel in the luggage compartment and is attached by a thumbnut.

The temporary spare wheel has been designed to be used for short periods of time. Have the tyre checked and replaced as soon as possible at a specialised CUPRA Service, SEAT Official Service or at a specialised workshop.

The spare wheel must not be switched for a spare wheel from another vehicle.

### Removing the temporary spare wheel

- Lift and hold up the floor panel to remove the temporary spare wheel >>> page 127.
- Turn the thumb wheel anti-clockwise >>> Fig. 267.

- Take out the temporary spare wheel.

### Getting the spare wheel out of vehicles with BEATS Audio 10 speakers (with subwoofer)\*

To remove the spare wheel, you must first remove the subwoofer.

- Lift and secure the luggage compartment floor as described in >>> page 127.
- Disconnect the *subwoofer* >>> Fig. 268 ①
- Turn the securing wheel in an anti-clockwise direction >>> Fig. 268 ②.
- Remove the *subwoofer* speaker and the spare wheel.
- When re-mounting the spare tyre, place the *subwoofer* on the base of the wheel rim with care. When doing so, the tip of the "FRONT" arrow on the *subwoofer* should point forward.
- Reconnect the speaker cable and firmly rotate the securing wheel clockwise so that the *subwoofer* system and wheel are firmly in place.

### Chains

For technical reasons, snow chains must not be used on the temporary spare wheel.

If you have a puncture on one of the front wheels when using snow chains, fit the temporary spare wheel in place of one of the

rear wheels. Fit the snow chains on the rear wheel that you have removed and replace the punctured front wheel with this wheel.

### ⚠ WARNING

- After fitting the temporary spare wheel, check the tyre pressures as soon as possible. Failure to do so may cause an accident. The tyre pressure is listed on the back of the left front door frame >>> Fig. 263.
- Do not drive at over 80 km/h (50 mph) when the temporary spare wheel is fitted on the vehicle: risk of accident!
- Never travel more than 200 km using a temporary spare wheel.
- Avoid heavy acceleration, hard braking and fast cornering: risk of accident!
- Never use more than one temporary spare wheel at the same time, risk of accident.
- No other type of tyre (normal summer or winter tyre) may be fitted on the compact temporary spare wheel rim.
- If you are driving using the spare wheel, the ACC system could automatically switch off during the journey. Switch off the system when starting off.

# Maintenance

## Service

### Service intervals

#### Service work and the Digital Maintenance Plan

##### Log of services performed (“Digital Maintenance Plan”)

Specialised CUPRA dealers, SEAT dealerships or a specialised workshop records Service receipts in a central system. Thanks to this comprehensive documentation of the service history, it is possible to reproduce the services performed any time. CUPRA recommends requesting a Service receipt after every service carried out containing all the services carried out on the system.

Whenever there is a new service the receipt is replaced with a current one.

**The Digital Maintenance Plan is not available in some markets. In this case, your specialised CUPRA dealer or a SEAT dealership will inform you about the current documentation of the work.**

#### Service works

In the Digital Maintenance Plan, your specialised CUPRA dealer, SEAT dealership or a specialised workshop will document the following information:

- When each one of the services was carried out.
- Whether a specific repair has been suggested, e.g. changing the brake pads in the near future.
- If you have expressed a special request for the maintenance. Your Service Advisor will write the work order.
- The components or fluids that were changed.
- The date of the next service.

The Long Life Mobility Warranty is valid until the next inspection. This information is documented in all checks performed.

The type and the volume of the service may vary from one vehicle to another. A specialised workshop will be able to provide specific information on the jobs for your vehicle.

#### WARNING

**If the services are insufficient or not performed and if the service intervals are not observed, the vehicle may be immobilised in traffic cause an accident and severe injuries.**

- Make sure that any repairs are carried out by a specialised CUPRA dealer, a SEAT dealership or a specialised workshop.

#### CAUTION

**CUPRA cannot be held liable for any damage to the vehicle due to insufficient work or of lack of availability of spare parts.**

#### Note

**Regular services on the vehicle not only maintain its value, but also its correct operation and road safety. For this reason, conduct the services in accordance with CUPRA guidelines.**

#### Set Service or Flexible Service Intervals

Services are classified as **oil change service** and **inspection**. The service interval display on the instrument panel display serves as a reminder of the next service.

Depending on the features, the engine and the conditions of use of the car, either the **Fixed service** or the **Flexible service** will be applied for an oil change service..

## How to know which type of service needs to his vehicle

- Check the tables below:

Oil change service <sup>a)</sup>		
PR No.	Type of service	Service interval
Q11	Fixed	Every 5000 km or after 1 year <sup>b)</sup>
Q12		Every 7500 km or after 1 year <sup>b)</sup>
Q13		Every 10000 km or after 1 year <sup>b)</sup>
Q14		Every 15000 km or after 1 year <sup>b)</sup>
Q16	Flexible	According to the service interval display

<sup>a)</sup> The data are based on normal conditions of use.

<sup>b)</sup> Whatever happens first.

## Inspection Service<sup>a)</sup>

According to the service interval display

<sup>a)</sup> The data are based on normal conditions of use.

Bear in mind the information about the specifications of the engine oil according to the VW standard »» page 319.

## Particular characteristics of the Flexible Service

Regarding the **Flexible Service**, the oil change service only has to be performed when the vehicle needs it. To calculate when you have to carry out this service, take into account the individual conditions of use and personal driving style. A major component of the flexible service the use of LongLife oil instead of conventional engine oil.

Bear in mind the information about the specifications of the engine oil according to the VW standard »» page 319.

**If you do not want to the flexible service you can select the fixed service However, a fixed service may affect service costs** The Service Advisor will gladly advise you.

## Service interval display

At CUPRA, the dates of the services are indicated by the service interval display on the instrument panel »» page 75 or in the **Vehicle settings** menu of the infotainment system »» page 80. The service interval display gives information for service dates that involve an engine oil change or an inspection. When the time for the corresponding service comes, additional work required, such as the change of brake fluid and the spark plugs, can be carried out.

## Information about the terms of use

The service intervals and groups are usually based on **normal conditions of use**.

If, on the other hand, the vehicle is under **adverse conditions of use**, some of the work must be carried out before the next service period or even between service intervals.

### Conditions of use adverse include:

- The use of fuel with a high sulphur content.
- Frequent short trips.
- Letting the engine idle for a long period of time, as in the case of taxis.
- Using the vehicle in areas with thick dust.
- Frequent driving with a trailer (depending on equipment).
- Using the vehicle mostly in situations with a lot of traffic and stops (e.g. in a city).
- Using the vehicle mostly in winter.

### This applies especially for the following parts (depending on equipment):

- Dust and pollen filter
- Air Care allergen filter
- Air filter
- Toothed chain
- Particulate filter

- Engine oil

The Service Advisor of your specialised workshop will gladly inform you about the need of performing service work between normal service intervals, always considering the conditions of use of your vehicle.

### WARNING

If the services are insufficient or not performed and if the service intervals are not observed, the vehicle may be immobilised in traffic and cause accidents and severe injuries.

- Make sure that any repairs are carried out by a specialised CUPRA dealer, a SEAT dealership or a specialised workshop.

### CAUTION

CUPRA cannot be held liable for any damage to the vehicle due to insufficient work or of lack of availability of spare parts.

### Service sets

Sets of services include all the **maintenance works** needed to ensure the safety and the smooth running of the vehicle (**depending on the conditions of use and the features of the vehicle**, such as the engine, gearbox, or operating fluids). Maintenance services are divided into *inspection* and *review serv-*

ices. Consult the details of the jobs required for your vehicle at:

- Your CUPRA dealer
- Your SEAT dealership
- Your specialised workshop

Due to technical reasons (continuous development of components) the sets of services may vary. Your specialised CUPRA dealer, any SEAT dealership or a specialised workshop always receives updated information about any modifications that are made.

## Additional service offers

### Approved spare parts

Original SEAT Spare Parts have been conceived for their vehicles and approved by SEAT, with a special emphasis on safety. These parts correspond exactly to the manufacturer's requirements in terms of design, accuracy of the measurements and materials. The original SEAT Spare Parts have been conceived exclusively for your vehicle. For this reason, we always recommend the use of Original SEAT Spare Parts. SEAT cannot be held liable for the safety and suitability of parts from other manufacturers.

### Approved spare parts

Approved spare parts, following the manufacturer's requirements, are an additional service to you, offering the possibility of replacing complete sets, such as: light engine, gearboxes, heads, control units, electrical components, etc.

These parts are, **approved parts**, and are the same as the factory parts, which are also approved spare parts.

### Original accessories

We recommend you only use CUPRA Original Accessories and CUPRA approved accessories for your vehicle. The reliability, safety and suitability of these accessories have been inspected specifically for this type of vehicle. CUPRA cannot be held liable for the safety and suitability of parts from other manufacturers.

### Mobility Service (Service Mobility)

Since the moment you purchase your CUPRA vehicle you will be able to enjoy the benefits and coverage of the CUPRA Mobility Service.

For the first two years after the purchase, your new CUPRA vehicle is automatically



covered by the CUPRA Mobility Service without additional costs.

If you wish to enjoy this service after this period, you can extend the Mobility Service as long as you carry out the recommended Inspection and Maintenance Services at a specialised CUPRA Service or SEAT Official Service.

If your CUPRA vehicle is immobilised due to a fault or an accident, our assistance services will help you keep moving.

Take into account that the Mobility Service differs depending on the country where the vehicle was purchased. For further information, ask your specialised CUPRA dealer, any SEAT dealership or visit the CUPRA website in your country.

## Warranty

### Fault-free operation warranty

Specialised CUPRA Services or SEAT Official Services ensure the perfect condition of new vehicles. Check the purchase agreement or complementary additional documentation provided by your Technical Service to see the conditions and the terms of the warranty. Consult further information in this regard in your specialised CUPRA Service or SEAT Official Service.

## Vehicle maintenance

### Maintenance and cleaning

#### Basic observations

Regular and careful care helps to maintain the value of your vehicle. In addition, it may become a prerequisite to demand the warranty in the event of corrosion damage and deficiencies in the paint coat of the body-work.

Specialised workshops have the necessary care products. Please follow the instructions for application on the packaging.

#### WARNING

- Cleaning products and other materials used for car care can be damaging to your health if misused.
- Always keep care products in a safe place, out of the reach of children. Danger of poisoning!

#### For the sake of the environment

- When purchasing car care products, chose products that are compatible with the environment.
- The waste from car-care products should not be disposed of with ordinary household waste.

### Washing the vehicle

The longer you take to clean the tanks, e.g. remains of insects, bird excrements, tree resin or anti frost salt adhered to your vehicle, the more damage it can cause to the surface. High temperatures, for instance strong sunlight, further intensify the damage.

Before washing the car, soften the dirt using plenty of water.

To remove encrusted dirt such as insects, bird droppings or tree resin, use a lot of water and a microfibre cloth.

Have the underside of the vehicle washed after the end of the anti frost salts in winter.

#### High pressure cleaning equipment

When washing the vehicle with a high-pressure cleaner, always follow the operating instructions for the equipment. This applies particularly to the operating pressure and the distance between the spraying water. Do not aim the jet directly to the side window gaskets, doors, covers or the panoramic sunroof\*; the same applies to tyres, rubber hoses, soundproofing material, sensors\* or camera lenses\*. Keep a distance of at least 40 cm.

Do not remove snow and ice with a high-pressure cleaner.



Do not use a nozzle that sprays the water out in a direct stream or one that has a rotating jet for forcing off dirt.

The water temperature must not exceed 60°C.

### Automatic car washes

Spray the vehicle before starting the car wash.

Make sure that the windows and the panoramic sunroof\* are closed and the wind-screen wipers are deactivated. Bear in mind the instructions of the car wash tunnel operator, especially if your vehicle has detachable parts.

Use of car washes without brushes if possible.

### Washing by hand

Clean your vehicle from top to bottom with a soft sponge or with a brush. Only use cleaning products that do not contain solvents.

### Washing vehicles with a matte paint by hand

To prevent damage to the vehicle when washing it, first remove the thicker dust and dirt. To remove traces of insects, grease and fingerprints, it is best to use a special cleaner for matte paint.

Apply the product with a microfibre cloth. To avoid damaging the surface of the paint, do not apply too much pressure.

Rinse with plenty of water. Then clean it with a neutral cleaning product and a soft microfibre cloth.

Rinse the vehicle again with plenty of water and then leave it to dry. Remove traces of water with a leather cloth.

#### WARNING

- Only wash the vehicle with the ignition switched off or according to the specifications of the car wash tunnel operator. Risk of accident!
- When cleaning the underbody or the inside of the wheel arches, protect yourself from sharp or pointy metal parts. Risk of cut!
- After cleaning the brakes could act more slowly due to moisture or, in winter, the ice on the brake discs and pads. Risk of accident! In this case the brakes should be dried by pressing the brake pedal several times.

#### CAUTION

- Before washing the vehicle in an automatic car wash, please make sure to retract the exterior mirrors to prevent them from being damaged. Electric exterior rearview

mirrors must always be folded/deployed electrically!

- Do not wash the vehicle in direct sunlight. Risk of damaging the paint job!
- Do not use sponges, abrasive household sponges or similar to clean insect remains. Risk of damaging the surface!
- Vehicle parts with matte paint:
  - Do not use polish or hard wax. Risk of damaging the surface!
  - Never select washing programs that include the use of wax. This could damage the appearance of matte paint.
  - Do not put stickers or magnets on parts with matte paint, as removing them may damage the paint.

#### For the sake of the environment

The car should only be washed in special wash bays. These places are prepared to prevent oily water from getting into the public drains.

### Cleaning and maintenance instructions

The cleaning and maintenance of individual components of the vehicle can be checked in the following tables. The contents should be understood merely as a recommendation. Go to your specialised workshop if you

have special questions or parts that are not listed. Take the general considerations into account »» **Δ** in Take special care with... on page 348.

### Cleaning the exterior

#### Windscreen wipers

Problem	Solution
Dirt	Soft cloth with wipers

#### Headlights / Tail lights

Problem	Solution
Dirt	Soft sponge with neutral soap solution <sup>a)</sup>

<sup>a)</sup> Neutral soap solution: two tablespoons maximum in 1 litre of water

#### Sensors / Camera lenses

Problem	Solution
Dirt	<i>Sensors:</i> soft cloth with a solvent-free cleaning product <i>Camera lenses:</i> soft cloth with an alcohol-free cleaning product
Snow/ice	Hand brush/Anti frost spray with no solvents

#### Wheels

Problem	Solution
Antifreeze salt	Water
Brake abrasion dust	Acid-free special cleaning product

#### End exhausts

Problem	Solution
Antifreeze salt	Water, if a steel cleaning product is required

#### Covers / Trims

Problem	Solution
Dirt	Neutral soap solution <sup>a)</sup> , if a steel cleaning product is required

<sup>a)</sup> Neutral soap solution: two tablespoons maximum in 1 litre of water

#### Paint

Problem	Solution
Paint flaws	Check the paint's colour code in an authorised service and re-store with a touch-up pencil
Spilled fuel	Immediately rinse with water
Environmental rust tank	Apply rust remover and then apply hard wax. Go to your specialised workshop if you have any queries

Problem	Solution
Corrosion	Have your specialised workshop take care of this
The water does not create droplets on the clean paint	Maintain with hard wax (at least 2 times a year)
No shine despite sober maintenance/paint	Treat with suitable wax and apply paint preservative afterwards if the wax used does not contain preservative ingredients
Tanks, e.g. insect remains, bird droppings, tree sap, road salt	Immediately soften with water and remove with a microfibre cloth
Fat-based dirt, e.g. cosmetic products or sunscreen	Delete immediately with a neutral soap solution <sup>a)</sup> and a soft cloth

<sup>a)</sup> Neutral soap solution: two tablespoons maximum in 1 litre of water

#### Carbon fibre parts

Problem	Solution
Dirt	Clean the same way as painted parts »» page 343

»

## Decoration slides

Problem	Solution
Dirt	Soft sponge with neutral soap solution <sup>a)</sup>

<sup>a)</sup> Neutral soap solution: two tablespoons maximum in 1 litre of water

## Interior cleaning

### Windows

Problem	Solution
Dirt	Apply windscreen cleaner and then dry with a cloth

### Covers / Trims

Problem	Solution
Dirt	Neutral soap solution <sup>a)</sup>

<sup>a)</sup> Neutral soap solution: two tablespoons maximum in 1 litre of water

### Plastic parts

Problem	Solution
Dirt	Damp cloth
Encrusted dirt	Neutral soap solution <sup>a)</sup> , if possible solvent-free plastic cleaner

<sup>a)</sup> Neutral soap solution: two tablespoons maximum in 1 litre of water

## Displays/instrument panel

Problem	Solution
Dirt	Soft cloth with a liquid crystal display cleaner

## Control panels

Problem	Solution
Dirt	Soft brush, then soft cloth with neutral soap solution <sup>a)</sup>

<sup>a)</sup> Neutral soap solution: two tablespoons maximum in 1 litre of water

## Seat belts

Problem	Solution
Dirt	Neutral soap solution <sup>a)</sup> , allowed to dry before retracting

<sup>a)</sup> Neutral soap solution: two tablespoons maximum in 1 litre of water

## Fabrics, artificial, Alcantara leather

Problem	Solution
Particles of dirt stuck to surfaces	Vacuum cleaner
Water-based dirt, e.g. coffee, tea, blood etc.	Absorbent cloth and neutral soap solution <sup>a)</sup>

Problem	Solution
Grease-based dirt, e.g. oil, make-up, etc.	Apply a neutral soap solution <sup>a)</sup> . Absorb the dissolved grease and paint particles drying with an absorbent cloth, in case you must treat it with water afterwards
Special dirt, e.g. pens, nail polish, dispersion paint, shoe cream etc.	Special stain remove: dry with an absorbent cloth, if applicable, apply neutral soap solution afterwards <sup>a)</sup>

<sup>a)</sup> Neutral soap solution: two tablespoons maximum in 1 litre of water

## Natural leather

Problem	Solution
Recent dirt	Cotton cloth with neutral soap solution <sup>a)</sup>
Water-based dirt, e.g. coffee, tea, blood etc.	Recent stains: absorbent cloth Dry stains: stain remover suitable for leather
Grease-based dirt, e.g. oil, make-up, etc.	Recent stains: absorbent cloth and suitable stain remover for leather Dry stains: grease solvent spray
Special dirt, e.g. pens, nail polish, dispersion paint, shoe cream etc.	Stain remover suitable for leather

Problem	Solution
Care	Apply preservative cream regularly to protect from sunlight. Use a colour preservative if required

a) Neutral soap solution: two tablespoons maximum in 1 litre of water

### Carbon fibre parts

Problem	Solution
Dirt	Clean like plastic parts

### Take special care with...

#### Headlights/tail lights

- Do not clean the headlights/tail lights with a dry cloth or sponge.
- Do not use cleaning products that contain alcohol. Risk of cracks!

#### Wheels

- Do not use for paint wax or other abrasive products.
- If the protective coating on the paint of the rim has been damaged due to stone impacts, scratches, etc., the damage should be repaired immediately.

#### Camera lenses

- Do not use hot or warm water to remove ice or snow from the camera lenses. Risk of cracking the lens!
- To clean the camera lens, never use abrasive cleaning products or products with alcohol. Risk of scratches and cracks!

#### Windows

- Remove snow and ice from windows and exterior mirrors with a plastic scraper only. To avoid scratches, the scraper should only be pushed in one direction and not moved to and fro.
- Never remove snow or ice from windows and rearview mirrors with warm or hot water. Risk of cracks on the windows!
- To prevent damage to the heating of the rear window, do not put stickers over the heating elements.

#### Covers/trims

- Do not use cleaning products or chrome based cleaning agents.

#### Paint

- The vehicle must be free from dirt and dust before applying wax or care products. Risk of scratches!
- Do not apply wax or care products if the vehicle is exposed to direct sunlight. Risk of damaging the paint job!

- The ambient rust deposits must not be removed through friction. Risk of damaging the paint job!
- Remove cosmetic products and sunlight immediately. Risk of damaging the paint job!

#### Displays/instrument panel

- The screens, the instrument panel and the trim around it must not be cleaned dry. Risk of scratches!
- Make sure that the instrument panel is switched off and cooled down before cleaning.
- Make sure that no liquid leaks between the instrument panel and the trim. Risk of damage!

#### Control panels

- Make sure that no liquid leaks into the control panels. Risk of damage!

#### Seat belts

- Do not remove the seat belts to clean them.
- Seat belts and their components must never be cleaned with chemical products, nor should they be allowed to come into contact with corrosive liquids, solvents or sharp objects. Risk of damaging the fabric!
- If you find any damage to the belt webbing, belt fittings, the belt retractor or the buckle, ask your specialised workshop to replace the belt in question.



### Fabrics/artificial leather/Alcantara leather

- Do not treat artificial leather/Alcantara leather with leather cleaning products, solvents, wax polish, shoe cream, stain removers or similar products.
- If the stain is very hard to remove, take the vehicle to a specialised workshop to have it removed there. This will prevent damage.
- Do not use steam cleaners, brushes, hard sponges, etc. to clean.
- Do not turn on seat heating\* to dry the seats.
- Sharp objects on clothing, such as zips, rivets or belts can damage the surface.
- Open Velcro, e.g. on clothes can damage the seat upholstery. Make sure that Velcro fasteners are closed.

### Natural leather

- Never use solvents, wax polish, shoe cream, spot removers or similar products on leather.
- Sharp objects on clothing, such as zips, rivets or belts can damage the surface.
- Do not use steam cleaners, brushes, hard sponges, etc. to clean.
- Do not turn on seat heating\* to dry the seats.
- Avoid exposing leather to direct sunlight for long periods, otherwise it may tend to

lose some of its colour. If the car is left for a prolonged period in the bright sun, it is best to cover the leather.

#### WARNING

Do not use water-repellent coatings on the windscreen. In bad visibility conditions such as humid weather, darkness or when the sun is in its lowest point, visibility may be impacted. Risk of accident! Such coatings can also cause the windscreen wiper blades to make noise.

#### Note

- Remains of insects can be removed much more easily with previously treated paint.
- Regular car care treatments can prevent deposits of ambient rust.

### Remove the vehicle from traffic

If you want to leave your vehicle stationary for a long period of time, contact a qualified workshop. They will gladly inform you about the necessary measures, such as anti-corrosion protection, Service and storage.

Also take into account instructions regarding the vehicle's battery >>> page 326.

## Accessories and modifications to the vehicle

### Accessories, spare parts and repair work

#### Introduction

Always ask your dealer or specialist retailer for advice before purchasing accessories and replacement parts.

Your vehicle is designed to offer a high standard of active and passive safety. For this reason, we recommend that you ask a specialised CUPRA Service or SEAT Official Service for advice before fitting accessories or replacement parts. Your Official Service has the latest information from the manufacturer and can recommend accessories and replacement parts which are suitable for your requirements. They can also answer any questions you might have regarding official regulations.

We recommend you to use only **CUPRA accessories** and **Genuine CUPRA parts**®. Specialised CUPRA Services or SEAT Official Services have the necessary experience and facilities to ensure that the parts are installed correctly and professionally.

Any **retro-fitted equipment** which has a direct effect on the vehicle and/or the way it is driven, such as a cruise control system or **electronically-controlled suspension**, must be approved for use in your vehicle and bear the **e** mark (the European Union's authorisation symbol).

If **any additional electrical devices** are fitted which do not serve to control the vehicle itself (for instance a refrigerator box, laptop or ventilator fan, etc.), they must bear the **CE** sign (manufacturer conformity declaration in the European Union).

### WARNING

Accessories, for example telephone holders or cup holders, should never be fitted on the covers, or within the working range of the airbags. Otherwise, there is a danger of injury if the airbag is triggered in an accident.

### Technical modifications

Modifications must always be carried out according to our specifications.

Unauthorised modifications to the electronic components, software, wiring or data transfer in the vehicle may cause malfunctioning. Due to the way the electronic components are linked together in networks, other indirect systems may be affected by

the faults. This can seriously impair safety, lead to excessive wear of components, and also invalidate your vehicle registration documents.

You will appreciate that your specialised CUPRA dealer or SEAT dealership cannot be held liable for any damage caused by modifications and/or work performed incorrectly in the vehicle.

We therefore recommend that all work should be performed by a specialised CUPRA Service or a SEAT Official Service using **genuine CUPRA parts**®.

### WARNING

Incorrectly performed modifications or other work on your vehicle can lead to malfunctions and cause accidents.

### Radio telephones and office equipment

#### Radio transmitters (fixed installation)

Any retrofit installations of radio transmitters in the vehicle require prior approval. CUPRA generally authorises in-vehicle installations of approved types of radio transmitters provided that:

- The aerial is installed correctly.

- The aerial is installed on the exterior of the vehicle (and shielded cables are used together with non-reflective aerial trimming).
- The effective transmitting power does not exceed 10 Watts at the aerial base.

A specialised CUPRA Service, SEAT Official Service or specialised workshop will be able to inform you about options for installing and operating radio transmitters with a *higher* transmitting power.

#### Mobile radio transmitters

Commercial mobile telephones or radio equipment might interfere with the electronics of your vehicle and cause malfunctions. This may be due to:

- No external aerial.
- External aerial incorrectly installed.
- Transmitting power more than 10 W.

You must, therefore, do not operate portable mobile telephones or radio equipment *inside the vehicle* without a properly installed external aerial »» .

Please note also that the maximum range of the equipment can only be achieved with an *external* aerial.

#### Business equipment

Retrofit installation of business or private equipment in the vehicle is permitted, »

provided the equipment cannot interfere with the driver's immediate control of the vehicle and that any such equipment carries the **CE** mark. Any retrofit equipment that could influence the driver's control of the vehicle must have a type approval for your vehicle and must carry the **e** mark.

### **WARNING**

Mobile telephones or radio equipment which is operated inside the vehicle without a properly installed external aerial can create excessive magnetic fields that could cause a health hazard.

### **Note**

- The posterior fitting of electric and electronic equipment in this vehicle affects its licence and could lead to the withdrawal of the vehicle registration document under certain circumstances.
- Please use the mobile telephone/radio operating instructions.



## Information for the user

### Information for the user

#### Information stored by the control units

##### Storage of accident data (Event Data Recorder)

Your vehicle has an event data recorder (EDR).

The EDR's function is to record data in the event of a mild or serious accident. These data are used to support the analysis of how different vehicle systems behaved.

The EDR records, over a reduced time range (normally 10 seconds or less), dynamic driving data and data from the restraint systems, such as:

- How different vehicle systems worked.
- Whether the driver and the occupants were wearing their seat belts.
- How hard the acceleration or brake pedal was pressed.
- Vehicle speed.

These data will provide a better understanding of the circumstances of the accident.

Data from the driving assist systems are also recorded. This includes data such as whether the systems were inactive or active and if such action had an impact on the vehicle's dynamic behaviour, changing its path in the aforementioned situations, accelerating or decelerating the vehicle.

Depending on vehicle equipment, this includes data from systems such as:

- Adaptive Cruise Control (ACC)
- Emergency brake assistance system (Front Assist).
- Park Pilot system
- Parking aid system (Park Assist).
- Lane Assist

The EDR data are only recorded in specific accident situations. No data are recorded in normal driving conditions.

No audio or video data inside or around the vehicle are recorded. Under no circumstances are personal data such as name, age, or gender recorded. Nevertheless, third parties (such as criminal proceedings authorities) may relate the contents of the EDR data to other data sources and create a personal reference in the context of an accident investigation.

In order to read the EDR data it is necessary to access (if legally permitted to do so) the

vehicle's ODB ("On-Board-Diagnose") interface while the vehicle is switched on.

CUPRA will not have access to EDR data unless the owner (or, in "Leasing" cases, the lessee or hirer) gives their consent. There may be exceptions to this, depending on legal or contractual provisions.

Due to legal requirements in safety-related products, CUPRA may use the EDR data for field research and in order to improve vehicle system quality. Any data used for the purposes of research will be treated anonymously (in other words, no reference will be made to the vehicle, their owner or the lessee/hirer).

## Other important information

### Environmental compatibility

Environmental protection is a top priority in the design, choice of materials and manufacture of your new CUPRA.

#### Constructive measures to encourage recycling

- Joints and connections designed for easy dismantling.
- Modular construction to facilitate dismantling.
- Increased use of single-grade materials. »

- Plastic parts and elastomers are marked in accordance with ISO 1043, ISO 11469 and ISO 1629.

### Choice of materials

- Use of recycled materials.
- Use of compatible plastics in the same part if its components are not easily separated.
- Use of recycled materials and/or materials originating from renewable sources.
- Reduction of volatile components, including odour, in plastic materials.
- Use of CFC-free coolants.

**Ban on heavy metals, with the exceptions dictated by law (Annex II of ELV Directive 2000/53/EC):** cadmium, lead, mercury, hexavalent chromium.

### Manufacturing methods

- Reduction of the quantity of thinner in the protective wax for cavities.
- Use of plastic film as protection during vehicle transport.
- Use of solvent-free adhesives.
- Use of CFC-free coolants in cooling systems.
- Recycling and energy recovery from residues (RDF).
- Improvement in the quality of waste water.

- Use of systems for the recovery of residual heat (thermal recovery, enthalpy wheels, etc.).
- The use of water-soluble paints.

### Recycling of electrical or electronic devices

All electrical or electronic devices (EED) that are not permanently fitted in the vehicle must be marked with the following symbol:



This symbol indicates that EED must not be discarded as home waste but through selective waste collection.

### Information about the EU Directive 2014/53/EU

#### Simplified EU compliance declaration

Your vehicle has different radioelectrical devices. The manufacturers of these devices declare that they comply with Directive 2014/53/EU when legally required.

The full text of the EU compliance declaration is available online at the following address:

[www.cupraofficial.com](http://www.cupraofficial.com)



### Table of correspondences

The table of correspondences will help you to associate the name of the device in the declaration of compliance with the features of the vehicle and the terminology used in the on-board documentation.

Features of the vehicle	Name of the device according to the declaration of compliance
Radiofrequency remote control (vehicle)	FS12A, FS12P
Radio frequency remote control (auxiliary heater)	Sender STH SEAT - 50000914
Auxiliary heating	50000864 / D208L VW
Bluetooth	MIB2 Main-Unit A580 / A270
Wireless hotspot	MIB2 Main-Unit A580 / A270
Keyless Access System	MQB-B B
Radar sensors for assistance systems	ARS4-B BSD3.0

## Information for the user

Features of the vehicle	Name of the device according to the declaration of compliance
Central control unit	5WK50254
	5WK50474
Infotainment system	MIB2 Main-Unit
	A580 / A270
Wireless charging	WCH-183
Connection to the external antenna of the car	UMTS/GSM-MMC-AG2
Instrument panel	Immobilizer integrated in dashboard module instrument cluster
Antenna	5Q0.035.507 Roof Antenna
	8S7.035.503.B

Features of the vehicle	Name of the device according to the declaration of compliance
Antenna amplifiers	575.035.225 575.035.225.A 575.035.225.B

### Addresses of the manufacturers

According to the Directive 2014/53/EU, all relevant components must include the address of the manufacturer.

The address of the manufacturers of components that, due to their size or nature, cannot include a sticker are listed below, as long as it is legally required:

Radioelectrical equipment fitted in the vehicle	Addresses of the manufacturers
Radiofrequency remote control key	Della KGaA Hueck & Co. Rixbecker Straße 75 59552 Lippstadt, GERMANY
Radio frequency remote control (auxiliary heater)	Digades gmbH Äußere Weberstraße 20 02763 Zittau, GERMANY
Radar sensors for assistance systems	ADC Automotive Distance Control Systems GmbH Peter-Dornier-Straße 10 88131 Lindau, GERMANY

### Frequency bands, station power

Radioelectrical equipment <sup>a)</sup>	Frequency band	Max. station power
Radiofrequency remote control (vehicle)	433.05-434.78 MHz	10 mW (ERP)
	433.05-434.79 MHz	10 mW
	868.0-868.6 MHz	25 mW
	434.42 MHz	32 µW
Radio frequency remote control (auxiliary heater)	868.7-869.2 MHz (869.0 MHz)	0.24 mW, / -6.3 dBm e.r.p.



## Information for the user

Radioelectrical equipment <sup>a)</sup>	Frequency band	Max. station power
Auxiliary heating	868.7-869.2 MHz (869.0 MHz)	23.5 mW, / 13.7 dBm e.r.p.
Bluetooth	2400-2483.5 MHz	10 dBm
Wireless hotspot	2400-2483.5 MHz	10 dBm
Connection to the external antenna of the car	GSM 900: 880-915 MHz	33 dBm
	GSM 1800: 1710-1785 MHz	30 dBm
	WCDMA FDD I: 1920-1980 MHz	24 dBm
	WCDMA FDD III: 1710-1785 MHz	24 dBm
Keyless Access	434.42 MHz	32 $\mu$ W
Radar sensors for assistance systems	76 GHz-77 GHz	35.0 dBm
	24050-24250 MHz	20 dBm
Wireless charging	110-120 kHz	10 W
Instrument panel	125 kHz	40 dB $\mu$ A/m

<sup>a)</sup> The commissioning or authorisation of radioelectrical technology may be restricted in some European countries, forbidden or only allowed with additional requirements.

# Technical data

## Indications about the technical data

### Important information

#### Introduction

The values indicated in the technical data may differ depending on optional equipment or version of the model, as well as in the case of special vehicles and equipment for certain countries.

The information in the official vehicle documentation takes precedence at all times.

#### Abbreviations used in the Technical Specifications section

kW	Kilowatt, engine power measurement.
PS	Pferdestärke (horsepower), formerly used to denote engine power.
rpm, 1/min	Revolutions per minute - engine speed.
Nm	Newton metres, unit of engine torque.
CZ	Cetane number, indication of the diesel combustion power.
RON	Research octane number, indication of the knock resistance of petrol.

#### Vehicle identification data

##### Vehicle ID number

The vehicle ID number can be found in the following places:

- In the infotainment system using the button  > **SETTINGS** > **Service** > **Vehicle ID number**.
- One the vehicle's data label.
- In front, under the windscreen.
- To the right in the engine compartment.

##### Type plate

The type plate is located on the vehicle's right hand door frame. Vehicles for certain export countries do not have a type plate.

#### Fuel consumption

Approved consumption values are derived from measurements performed or supervised by certified EU laboratories, according to the legislation in force at the time (for more information, see the Publications Office of the European Union on the EUR-Lex website: © European Union, <http://eur-lex.europa.eu/>) and apply to the specified vehicle characteristics.

The values relating to fuel consumption and CO<sub>2</sub> emissions can be found in the docu-

mentation provided to the purchaser of the vehicle at the time of purchase.

Fuel consumption and CO<sub>2</sub> emissions depend on the equipment/features of each individual vehicle, as well as on the driving style, road conditions, traffic conditions, environmental conditions, load or number of passengers.

#### Filling capacities

##### Tank level

Petrol engines	55l, 8.5l reserve
----------------	-------------------

##### Capacity of the windscreen washer fluid container

Versions without headlight washer system	approx. 3 litres
Versions with headlight washer system	approx. 5 litres

#### Weights

##### Load on the roof

The maximum authorised load on the roof of your vehicle is 75 kg. »

### Empty weight, total weight, axle loads

The empty weight of the vehicle with driver (75 kg) was calculated according to the (EU) 1230/2012 standard. Optional equipment can increase the empty weight, which means that the possible useful load decreases proportionally.

### Trailer weight

The maximum permitted drawbar load on the ball head of the towing bracket is **88 kg**.

#### **WARNING**

The values indicated for the maximum permitted weights must not be exceeded.  
There is a risk of accident and damage!

### Engine specifications

	2.0 TSI Start-Stop
Power output in kW (PS) at 1/min	221 (300)/5,300-6,500
Maximum torque (Nm at 1/min)	400/2,000-5,200
No. of cylinders/displacement (cm <sup>3</sup> )	4/1,984
Fuel	Super 98 / Super 95 (with a slight power loss) ROZ
Gearbox	DSG 4Drive
Top speed (km/h)	247 (6)
Acceleration from 0-100 km/h (seconds)	5.2
Maximum authorised weight (kg)	2,150

Dimensions.

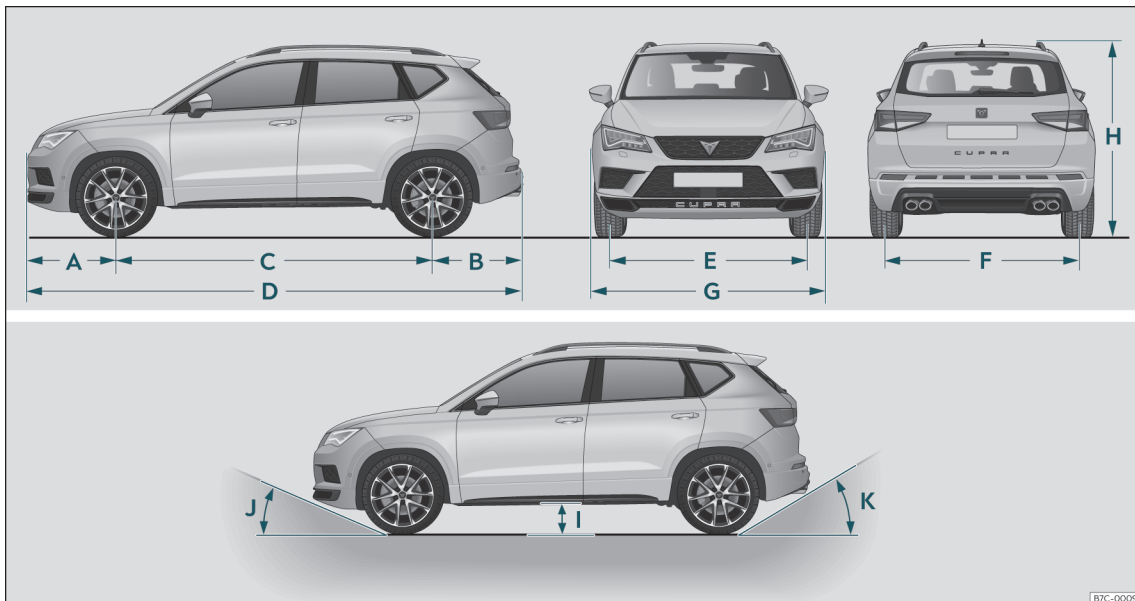

Fig. 269 Dimensions and angles.

B7C-0009



## Indications about the technical data

»» Fig. 269		Ateca 4Drive
A	Front projection (mm)	868
B	Rear projection (mm)	877
C	Wheelbase (mm)	2,631
D	Length (mm)	4,376
E	Front track (mm)	1,573
F	Back track (mm)	1,547
G	Width (mm)	1,841
H	Height at kerb weight (mm)	1,601 <sup>a)</sup> 1,615 <sup>b)</sup>
I	Ground clearance between the axles (mm)	175
J	Front projection angle limited by the bumper	maximum 18.9°
K	Rear projection angle limited by the bumper	maximum 23.6°
	Turning radius (m)	10.8

Values for the 245/40 R19 ET45 wheel and the 2.0 TSI 221 kw engine

a) Distance to the roof.

b) Dimension to the roof bars.



## Index

## Numbers and Symbols

4Drive ..... 243

## A

## ABS

see Anti-lock brake system ..... 279

ACC ..... 255

radar sensors ..... 257

Accessories ..... 348

Adaptive Cruise Control ..... 255

control and warning lamp ..... 256

function to prevent overtaking on the

right ..... 261

indications on the screen ..... 257

malfunction ..... 256

operating ..... 258

radar sensors ..... 257

special driving situations ..... 261

temporarily deactivating ..... 261

## Adjust

front seats ..... 120

headrest ..... 122

lights ..... 113

seats ..... 12

time ..... 73

vehicle menu ..... 80

Adjusting the seat belt ..... 19

Airbags ..... 21

description ..... 21

Airbag system ..... 21

activation ..... 22

control lamp ..... 23

deactivation of the front airbag ..... 25

description ..... 21

front airbags ..... 23

how it works ..... 22

## Air conditioning

Climatronic ..... 138

usage instructions ..... 140

Air recirculation ..... 141

Air vents ..... 141

## Alternator

warning lamp ..... 327

AM ..... 170

Ambient lighting ..... 114

Android Auto™ ..... 163, 165

Anti-lock brake system ..... 279

Anti-puncture ..... 38, 39

Anti-puncture kit ..... 38

check after 10 minutes ..... 41

components ..... 39

inflating the tyre ..... 39

sealing the tyre ..... 39

Anti-puncture set ..... 38

Anti-theft alarm system ..... 93

trailer ..... 306

## Anti-trap function

sunroof ..... 106

sunshade blind (glass roof) ..... 106

windows ..... 104

Antifreeze ..... 322

## App

Media Control ..... 166

Apple CarPlay™ ..... 163, 164

## Aspects to think about before starting the

vehicle ..... 11

## ASR

see Traction control system ..... 279

## Assistance systems

ACC ..... 255

adaptive cruise control ..... 255

assisted parting system (Park Assist) ..... 283

Auto Hold function ..... 278

blind spot detector (BSD) with parking as-

sistant (RCTA) ..... 269

connecting ..... 77

cruise control ..... 246

disconnecting ..... 77

driver alert system ..... 69

Emergency Assist ..... 268

emergency braking (Front Assist) ..... 251

hill descent control (HDC) ..... 239

parking aid Plus ..... 291

peripheral view system (Top View Cam-

era) ..... 296

rear cross traffic alert (RCTA) ..... 269

rear parking aid ..... 294

road sign detection system messages ..... 70

speed limiter ..... 248

traffic jam assist ..... 266

tyre control ..... 337

tyre pressure loss indicator ..... 337

Assisted start ..... 46

## Audible warning

control and warning lamps ..... 77

lights ..... 107

unbuckled seat belt ..... 15

Auto Hold ..... 278

Auto Hold Function ..... 278

Auto Lock (central locking) ..... 87

- Automatic car wash ..... 344  
   disconnecting the Auto Hold function ..... 279
- Automatic dipped beam headlight control ..... 108
- Automatic gearbox ..... 232  
   control lamp ..... 232  
   downhill assistant ..... 237  
   driving tips ..... 235  
   emergency release of the selector lever ..... 238  
   kick-down ..... 235  
   launch-control program ..... 236  
   operating fault ..... 235  
   selector lever lock ..... 233  
   selector lever positions ..... 232  
   steering wheel with shift paddles ..... 234  
   tiptronic ..... 232, 234  
   towing ..... 49
- AUX-IN ..... 224  
   external audio source ..... 188
- Average fuel consumption ..... 63
- ## B
- Backrest of the rear seat  
   folding ..... 123  
   raise ..... 123
- Bag hooks ..... 130, 134
- Battery ..... 86
- Before starting the vehicle ..... 11
- Belt tightening ..... 20
- Bicycle carrier  
   fitting onto the coverable tow hook ..... 311  
   max. load rating ..... 311
- Blind spot detector (BSD) ..... 269, 270  
   control lamps ..... 270  
   driving situations ..... 272  
   how it works ..... 271  
   indication on the exterior mirror ..... 271  
   malfunction ..... 270  
   trailer ..... 274
- Blown bulbs  
   change a bulb ..... 56
- Bluetooth®  
   connect audio source ..... 189
- Bonnet ..... 316, 319  
   opening and closing ..... 318
- Brake fluid ..... 324
- Brakes ..... 275  
   brake fluid ..... 324  
   brake servo ..... 275  
   braking assistant ..... 279  
   electronic parking brake ..... 276  
   emergency brake function ..... 277  
   new brake pads ..... 275
- Braking assistant ..... 279
- Braking system  
   warning lamp ..... 274
- BSD  
   see blind spot detector (BSD) ..... 269
- BSD Plus ..... 265
- ## C
- Camera  
   cleaning ..... 72  
   Lane Assist ..... 263
- Capacities  
   window washer water ..... 325
- Care  
   see Cleaning the vehicle ..... 343
- Central armrests ..... 124
- Central locking ..... 87  
   anti-theft alarm ..... 93  
   central locking switch ..... 89  
   emergency lock ..... 97  
   Keyless Access ..... 90  
   remote control key ..... 89  
   selective unlocking system ..... 89  
   settings ..... 88
- Change a bulb ..... 56  
   number plate light ..... 58  
   tail light bulb in the bodywork ..... 57  
   tail light bulb in the rear lid ..... 58
- Change the wiper blades ..... 45
- Changing a wheel ..... 41  
   subsequent work ..... 44  
   wheel nuts ..... 42
- Changing parts ..... 348
- Checking levels  
   engine compartment ..... 319
- Childproof locks  
   electric windows ..... 102
- Child seats  
   group classification ..... 29  
   ISOFIX system ..... 33  
   safety instructions ..... 30  
   securing with the seat belt ..... 36  
   Top Tether system ..... 33, 35, 36
- Cleaning the vehicle  
   Alcantara ..... 346  
   carbon fibre ..... 345, 347  
   control panels ..... 346  
   covers/ trims ..... 345, 346  
   decorative sheets ..... 346  
   end exhausts ..... 345  
   exterior ..... 345

- fabrics ..... 346
- headlights/tail light units ..... 345
- high pressure cleaning equipment ..... 343
- interior ..... 346
- leather ..... 346
- paint ..... 345
- plastic parts ..... 346
- radio screen ..... 346
- seat belts ..... 346
- sensors / camera lenses ..... 345
- special care ..... 347
- wash the vehicle ..... 343
- wheels ..... 345
- windows ..... 346
- wiper blades ..... 345
- Climate control
  - windscreen heating ..... 142
- Climatronic ..... 138
- Clocks
  - digital ..... 73
  - set the time ..... 73
- Closing ..... 87
  - bonnet ..... 318
  - rear lid ..... 99
  - sunroof ..... 105
  - sunshade blind (glass roof) ..... 105
  - windows ..... 102
- Clutch (lamp) ..... 238
- Coming Home ..... 111
- Communication between the Infotainment System and mobile devices ..... 160
- Connectivity ..... 160
  - Full Link ..... 160
  - Media Control ..... 166
  - WLAN access point ..... 167
- Connectivity Box ..... 224
- Connectors
  - faults ..... 136
- Control and warning lamps ..... 77
  - adaptive cruise control ..... 256
  - airbags ..... 25
  - airbag system ..... 23
  - alternator ..... 327
  - anti-lock brake system ABS ..... 279
  - ASR ..... 279, 281
  - audible warning ..... 77
  - blind spot detector (BSD) ..... 270
  - braking system ..... 274
  - cruise control (GRA) ..... 246
  - diesel preheating system ..... 315
  - EDL ..... 279
  - electromechanical steering ..... 241
  - electronic parking brake ..... 274
  - emissions control ..... 315
  - engine management ..... 315
  - engine oil ..... 320
  - ESC ..... 279, 281
  - gear change ..... 238
  - hill descent control ..... 239
  - Lane Assist ..... 264
  - lights ..... 107
  - particulate filter ..... 315, 316
  - press on the brake ..... 251, 256
  - rear cross traffic alert (RCTA) ..... 270
  - refuelling ..... 313
  - replacement ..... 232
  - seat belt ..... 15
  - speed limiter ..... 248
  - Start-Stop ..... 230
  - steering column lock ..... 241
- tow hook ..... 310
- tyre pressure loss indicator ..... 337
- Control lamps
  - engine coolant ..... 74
  - fuel reserve ..... 73
  - refuelling ..... 73
- Controls and displays
  - overview ..... 61
- Controls on the steering wheel ..... 83
- Convenience close function
  - windows ..... 103
- Convenience open function
  - windows ..... 103
- Cooling system
  - check the coolant ..... 323
  - refilling coolant ..... 323
- Copyright ..... 177
  - information ..... 155
- Correct sitting position ..... 12
  - driver ..... 12
- Cruise control ..... 246
  - control and warning lamp ..... 246
  - operation ..... 248
- D**
- DAB ..... 170
  - see: RADIO ..... 172
- Dangers of not using the seat belt ..... 17
- Data label ..... 355
- Data transfer ..... 160
- Deactivation of the front airbag ..... 25
- Delayed shutdown (Infotainment system) .. 150
- Diesel
  - engine oil ..... 319

- Digital Cockpit ..... 63  
 information profiles ..... 63  
 navigation map ..... 64
- Display of road signs on the instrument panel  
 activate ..... 71  
 deactivate ..... 71
- Disposal  
 seat belt tensioners ..... 20
- Distance control  
 see Adaptive Cruise Control ..... 255
- Door cylinder ..... 96  
 Door handle ..... 96  
 Door lock ..... 96  
 Doors ..... 96  
 child lock ..... 97
- Downhill assistance function ..... 237  
 Downhill assistant ..... 237
- Drawers ..... 133
- Drink holder ..... 134  
 bottle holder ..... 134
- Drive Profile ..... 241
- Driver  
 see Correct sitting position ..... 12
- Driver alert system ..... 69
- Driving  
 driving on flooded roads ..... 246  
 economical ..... 244  
 parking on inclines ..... 282  
 park on upward slopes ..... 282  
 safe ..... 11  
 trips abroad ..... 113, 246  
 with trailer ..... 308
- Driving data ..... 67
- Driving data indicator ..... 67
- Driving mode ..... 242
- Driving on flooded roads ..... 246
- Driving profile ..... 242
- DSG ..... 232
- Duplicate keys ..... 85
- Dust and pollen filter ..... 137
- DVD ..... 186, 192  
 settings ..... 193
- Dynamic headlight range control ..... 113
- ## E
- Easy Connect ..... 80
- Easy Open ..... 90  
 special characteristics ..... 101
- EDL  
 see Electronic differential lock ..... 279
- Electric  
 windows ..... 102
- Electric devices ..... 135
- Electric windows ..... 102
- Electrolyte ..... 327
- Electromechanical steering ..... 240  
 lamp ..... 240
- Electronic differential lock ..... 279
- Electronic engine torque management  
 (XDS) ..... 280
- Electronic immobilizer ..... 96, 228
- Electronic parking brake ..... 276  
 lamp ..... 274
- Electronic self-locking ..... 279
- Electronic Stability Control (ESC) ..... 279
- Emergencies ..... 38  
 anti-puncture kit ..... 38  
 changing a wheel ..... 41  
 changing the battery ..... 327
- emergency vehicle towing ..... 49  
 hazard warning lights ..... 112  
 jump leads ..... 46  
 replace a blown fuse ..... 54  
 vehicle tool kit ..... 38
- Emergency Assist ..... 268  
 connecting ..... 268  
 disconnecting ..... 268  
 see Emergency Assistant ..... 268
- Emergency brake function ..... 277
- Emergency braking assist system  
 indications on the screen ..... 251  
 malfunction ..... 252  
 operation ..... 254  
 radar sensors ..... 253  
 system limitations ..... 255  
 temporarily deactivating ..... 254
- Emergency braking warning ..... 113
- Emergency locking of the front passenger  
 door ..... 97
- Emergency opening  
 driver's door ..... 96  
 rear lid ..... 102
- Emergency operation  
 front passenger door ..... 97  
 gear selector lever ..... 238
- Emissions control system  
 control lamp ..... 315  
 particulate filter ..... 316
- Energy management ..... 328
- Engine  
 assisted start ..... 46  
 noises ..... 227  
 running in ..... 243

- Start-Stop system ..... 230  
 start (driver instructions with the mechanical contact) ..... 229
- Engine and ignition  
 automatic ignition disconnection ..... 226  
 emergency start ..... 229  
 My Beat ..... 229  
 preheat the engine ..... 227  
 starting the engine ..... 227  
 starting the engine with Press & Drive ..... 227  
 switching off the engine ..... 227
- Engine compartment ..... 316, 319  
 battery ..... 326  
 brake fluid ..... 324  
 coolant ..... 322, 323  
 engine oil ..... 321  
 opening and closing ..... 318  
 safety instructions ..... 316  
 window washer tank ..... 325
- Engine coolant ..... 322  
 check the level ..... 323  
 control lamp ..... 74  
 G12evo ..... 322  
 G 12 plus-plus ..... 322  
 G 13 ..... 322  
 specifications ..... 322  
 temperature indicator ..... 74  
 warning lamp ..... 74
- Engine failure  
 control lamp ..... 315
- Engine management ..... 315  
 control lamp ..... 315
- Engine oil ..... 319  
 change ..... 319, 322  
 checking the oil level ..... 320
- consumption ..... 320  
 dipstick ..... 320  
 inspection service ..... 319  
 maintenance frequencies ..... 319  
 refill ..... 321  
 specifications ..... 319
- Engine oil pressure  
 control lamp ..... 320
- Engine specifications ..... 357
- Environment  
 ecological driving ..... 244  
 environmental compatibility ..... 351  
 refuelling ..... 314
- Environmental tip  
 refuelling ..... 313
- Equipment ..... 348
- ESC  
 electronic stability control (ESC) ..... 279  
 multi-collision brake ..... 280  
 Sport mode ..... 281
- Event Data Recorder ..... 351
- Exterior lighting  
 change a bulb ..... 56
- Exterior mirrors  
 driving with a trailer ..... 305  
 folding ..... 117  
 heated ..... 117  
 settings ..... 117
- Exterior view ..... 7
- External antenna ..... 349
- F**
- Fabrics: clean ..... 346
- Factors that have a negative influence on safe driving ..... 11
- Fastening rings ..... 128
- Filling capacities  
 fuel tank ..... 355  
 window washer tank ..... 355
- Filling the tank ..... 313
- FM ..... 170
- Four-wheel drive ..... 243  
 snow chains ..... 244  
 towing ..... 49  
 winter tyres ..... 244
- Frequency band  
 AM ..... 170  
 change ..... 170  
 DAB ..... 170  
 FM ..... 170
- Front airbags ..... 23
- Front Assist  
 see Emergency braking assist system ..... 251
- Front drink holders ..... 135
- Front passenger front airbag  
 control lamp ..... 23
- Fuel ..... 314  
 fuel gauge ..... 73  
 identification ..... 314  
 petrol ..... 314  
 refuelling ..... 313  
 saving ..... 244
- Fuel consumption  
 inertia disconnection ..... 244  
 why does consumption increase? ..... 315
- Fuel gauge ..... 73  
 control lamp ..... 73
- Fuel tank cap  
 opening and closing ..... 313

- Fuel tank flap
    - opening and closing ..... 313
  - Full-LED headlights ..... 56
  - Full Link ..... 160
    - pairing ..... 163
    - settings ..... 163
  - Function buttons ..... 151
  - Fuses ..... 52
    - colour coded ..... 54
    - fuse box ..... 53, 54
    - preparations for replacing fuses ..... 54
    - recognise blown fuses ..... 54
    - replace ..... 54
- ## G
- GALA (speed-dependent volume) ..... 155
  - Gear-change recommendation ..... 239
  - Gearbox DSG
    - see Automatic gearbox ..... 232
  - Gear indication ..... 239
  - Glove compartment ..... 133
- ## H
- Handbrake
    - see Electronic parking brake ..... 276
  - Hangers ..... 134
  - Hazard warning lights ..... 112
  - HDC
    - see Hill descent control (HDC) ..... 239
  - Head-on collisions and the laws of physics ... 17
  - Head-protection airbags
    - safety instructions ..... 28
  - Headlights
    - change a bulb ..... 56
    - headlight washer ..... 115
    - trips abroad ..... 113
  - Headrest ..... 121, 122
  - Hill descent control (HDC).
    - control lamp ..... 239
  - Horn ..... 61
- ## I
- Identification of fuels ..... 314
  - Identifying letters on engine (LDM)
    - display ..... 66
  - Inertia mode ..... 237
  - Information profiles ..... 63
  - Infotainment buttons ..... 150
  - Infotainment System ..... 144
    - automatic playback (SCAN) ..... 175
    - AUX-IN ..... 188
    - Bluetooth® audio ..... 189
    - Bluetooth® settings ..... 222
    - CD or DVD player ..... 186
    - change the volume ..... 151
    - checkboxes ..... 151
    - DVD ..... 192
    - DVD settings ..... 193
    - factory settings ..... 154
    - FM, AM, DAB settings) ..... 176
    - function buttons ..... 151
    - general instructions for use ..... 150
    - image settings ..... 194
    - images main menu ..... 194
    - infotainment buttons ..... 150
    - initial configuration ..... 154
    - input window ..... 152
  - Internet access ..... 168
  - Jukebox (SSD) ..... 190
  - Media settings ..... 195
  - memory card ..... 187
  - mute ..... 151
  - navigation ..... 195
  - navigation settings ..... 205
  - on-screen keyboard ..... 152
  - overview of the unit ..... 146
  - phone settings ..... 222
  - preset buttons ..... 173
  - Radio mode ..... 170
  - road signs indication ..... 205
  - rotary/push buttons ..... 150
  - safety instructions ..... 144
  - scroll button ..... 152
  - scroll (screen) ..... 152
  - search on lists ..... 152
  - selecting, tuning and saving stations ..... 174
  - share a WLAN connection ..... 168
  - sound distribution (Balance and Fader) ... 155
  - station logos ..... 173
  - switching on and off ..... 150
  - system settings ..... 154
  - Telephone mode ..... 213
  - text entry ..... 152
  - touch screen ..... 151
  - traffic information ..... 175
  - updating navigation data ..... 195
  - USB ..... 187
  - user profile settings ..... 223
  - Vehicle menu ..... 209
  - voice control ..... 156
  - voice control settings ..... 159
  - volume and sound settings ..... 155



- wait time ..... 150  
 Wi-Fi Protected Setup (WPS) ..... 168  
 WLAN ..... 168  
 WLAN audio ..... 191  
 WLAN settings ..... 192  
 Infotainment system: ..... 80  
 Inspection ..... 319, 340  
 Inspection service ..... 319  
 Instrument panel ..... 62, 63  
   control and warning lamps ..... 77  
   digital (Digital Cockpit) ..... 63  
   display ..... 63  
   indications on the screen ..... 65, 66  
   instruments ..... 63  
   menu structure ..... 66  
   service intervals display ..... 75  
   use with the multifunction steering wheel ..... 76  
 Instrument panel display ..... 63, 65  
 Instrument panel lighting ..... 114  
 Instruments ..... 63  
 Interferences caused by mobile phones ..... 150  
 Interior mirror  
   anti-dazzle ..... 117  
 Interior monitoring and the anti-tow system  
   activation ..... 95  
 Interior view ..... 10  
 Interlock button ..... 233  
 ISOFIX ..... 33  
 ISOFIX system ..... 33
- J**  
 Jack ..... 38  
   position points ..... 43  
 Jukebox (SSD) ..... 190  
 Jump leads ..... 46
- Jump start ..... 46  
   description ..... 47
- K**  
 Keyless Access  
   Easy Open ..... 90  
   Keyless Entry ..... 90  
   Keyless Exit ..... 90  
   Press & Drive ..... 226  
   special characteristics ..... 92  
   starting the engine ..... 227  
   unlocking and locking the vehicle ..... 90  
 Keyless Access lock and ignition system:  
   see Keyless Access ..... 90  
 Keyless Entry  
   see Keyless Access ..... 90  
 Keyless Exit  
   see Keyless Access ..... 90  
 Keys  
   assign a key ..... 85  
   changing the battery ..... 86  
   instructions for the driver (mechanical  
     contact) ..... 229  
   remote control ..... 85  
   spare key ..... 85  
   synchronise ..... 87  
   unlock and lock ..... 89, 96  
   vehicle key ..... 85  
 Key switch ..... 25  
 Kick-down  
   automatic gearbox ..... 235
- L**  
 Lane Assist ..... 263  
   control and warning lamp ..... 264  
 Lane Assist system  
   see Lane Assist ..... 263  
 Launch-control (automatic transmission) ..... 236  
 Leather: clean ..... 346  
 Leaving a parking space with the parking as-  
   sist system ..... 288  
 Leaving Home ..... 111  
 Levels control ..... 355  
 Lift the vehicle ..... 43  
 Light Assist ..... 110  
 Lights ..... 107  
   audible warnings ..... 107  
   AUTO ..... 108  
   change a bulb ..... 56  
   coming home ..... 111  
   control and warning lamps ..... 107  
   control lighting ..... 114  
   controlling the lights ..... 107  
   daylight ..... 108  
   dipped beam headlights ..... 107  
   dynamic headlight range control ..... 113  
   fog light ..... 109  
   instrument lighting ..... 114  
   interior lights ..... 114  
   leaving home ..... 111  
   main beam headlight lever ..... 109  
   main beam headlights ..... 107  
   motorway light ..... 108  
   reading lights ..... 114  
   side lights ..... 107  
   switch ..... 107

- switching on and off ..... 107
  - turn signal lever ..... 109
  - welcome light ..... 112
  - Loading the luggage compartment
    - fastening rings ..... 128
    - general advice ..... 124
    - luggage compartment ..... 98, 124
    - positioning the load ..... 124
    - positioning the luggage ..... 124
    - roof carrier system ..... 132
    - trailer ..... 307
    - trapdoor for transporting long objects ... 130
  - Load on the roof ..... 132
    - technical data ..... 132
  - Lock and unlock
    - in the locking cylinder ..... 96
    - with Keyless Access ..... 90
    - with the central locking switch ..... 89
  - Luggage compartment ..... 98, 124
    - electric opening and closing ..... 99
    - emergency unlocking ..... 102
    - features of the electric rear lid ..... 100
    - luggage compartment lighting ..... 114
    - net bag ..... 129
    - storing the rear shelf ..... 126
    - variable luggage compartment floor ..... 127
  - Luggage compartment floor ..... 127
  - Luggage compartment shelf
    - storing ..... 126
  - Lumbar support ..... 120
- M**
- Main beam assist ..... 110
  - Main beam headlight lever ..... 109
  - Maintenance
    - see Service ..... 340
  - Maintenance frequencies ..... 319
  - Malfunctions
    - adaptive cruise control ..... 256
    - assisted parking system (Park Assist) ..... 283
    - clutch ..... 238
    - emergency brake assistance system (Front Assist) ..... 252
    - replacement ..... 238
    - sunroof ..... 105
    - towing device ..... 307
  - Manual gearbox
    - towing ..... 49
  - Mats ..... 14
  - Media
    - changing track ..... 184
    - copyright ..... 177
    - indications and symbols ..... 183
    - main menu ..... 182
    - playback modes ..... 182
    - playback order ..... 181
    - requirements for data media ..... 178
    - select track ..... 185
    - switching the Media source ..... 183
    - unreadable CD or DVD ..... 187
  - MEDIA
    - settings ..... 195
  - Media Control ..... 166
    - data transmission and control functions .. 167
  - Memory card ..... 187
  - MirrorLink ..... 164
  - Mirrors ..... 117
    - adjusting the exterior mirrors ..... 117
    - anti-dazzle interior ..... 117
    - see also Mirrors ..... 117
  - Mobile ..... 349
  - Mobile phones ..... 349
  - Mobile Signal Amplifier ..... 224
  - Multi-collision brake ..... 280
  - Multifunction display ..... 67
  - Multifunction steering wheel
    - with voice control ..... 83
  - Multimedia ..... 224
  - My Beat ..... 229
- N**
- Navigation ..... 195
    - change view ..... 201
    - entering the destination ..... 197
    - import vCards ..... 204
    - indications and symbols ..... 197
    - main menu ..... 197
    - my destinations ..... 199
    - navigation with images ..... 205
    - offroad navigation ..... 207
    - predictive navigation ..... 204
    - road signs indication ..... 205
    - route ..... 199
    - selecting the destination on the map .... 198
    - settings ..... 205
    - special destinations (POI) ..... 201
    - split screen ..... 202
    - traffic bulletins (TRAFFIC) ..... 203
    - updating the installing navigation data ... 196
  - Net bag
    - luggage compartment ..... 129

- Net for luggage  
luggage compartment ..... 129
- Noise  
adaptive cruise control ..... 256  
brakes ..... 275  
ESC ..... 281  
parking brake ..... 277  
tyres ..... 331, 335
- Number of seats ..... 13
- O**
- Octane (petrol) ..... 314
- Odometer ..... 63  
partial ..... 63  
total ..... 63
- Offroad Navigation ..... 207
- Oil change ..... 322
- One-touch signalling function ..... 109
- Opening ..... 87  
bonnet ..... 318  
rear lid ..... 99  
sunroof ..... 105  
sunshade blind (glass roof) ..... 105  
tank cap ..... 313  
windows ..... 102
- Opening and closing ..... 87  
bonnet ..... 318  
by remote control ..... 89  
doors ..... 96  
in the locking cylinder ..... 96  
rear lid ..... 98  
rear lid with electric opening and closing ..... 99  
sunroof ..... 105  
tank cap ..... 313
- windows ..... 102  
with the central locking switch ..... 89
- Operating fault  
automatic gearbox ..... 235
- Operation in winter  
battery ..... 326  
headlight washer ..... 116  
heated windscreen washer jets ..... 115  
salt on the roads ..... 117  
snow chains ..... 336  
tyres ..... 335
- Original Spare Parts ..... 342
- Overview  
of the instruments ..... 63  
of the menu structure ..... 66
- Overview (left hand drive) ..... 8
- Overview (right hand drive) ..... 9
- P**
- Painting the vehicle  
care ..... 345
- Panoramic sliding sunroof  
see Sunroof ..... 104
- Park Assist  
see the assisted parking system (Park Assist) ..... 283
- Parking ..... 282  
with the assisted parking system (Park Assist) ..... 287
- Parking aid  
automatic activation ..... 292  
braking during the manoeuvre ..... 294  
fault ..... 293, 295  
parking aid plus ..... 291  
rear parking aid ..... 294
- see the assisted parking system (Park Assist) ..... 283  
sensors and camera: clean ..... 345  
setting the indications and audio signals ..... 293, 295  
surroundings warning ..... 291  
towing device ..... 295  
trailer mode ..... 294  
visual indication ..... 293, 296
- Parking aid system  
see Parking aid ..... 290, 291, 294
- Parking aid system (Park Assist) ..... 283  
angle parking ..... 287  
automatic brake operation ..... 289  
automatic interruption ..... 284  
conditions for leaving a parking space ..... 288  
leaving a parking space (only when parallel parked) ..... 288  
malfunction ..... 283  
parallel parking ..... 287  
parking conditions ..... 287  
stop early ..... 284
- Parking brake  
automatic connection ..... 277  
automatic disconnection ..... 277  
connecting ..... 276  
disconnecting ..... 277  
emergency brake function ..... 277
- Parking distance warning system  
see Parking aid ..... 290, 291, 294
- Parking (automatic transmission) ..... 235
- ParkPilot  
see Parking aid ..... 290, 291, 294
- Partial odometer ..... 66
- Particulate filter ..... 316

- Pedals ..... 13, 14
- Peripheral view system (Top View Camera) . 296
- display ..... 298
- menus ..... 299
- modes ..... 299
- special characteristics ..... 298
- usage instructions ..... 298
- Petrol
- additives ..... 314
- particulate filter ..... 316
- refuelling ..... 314
- Power socket ..... 135
- 12 Volts ..... 135
- faults ..... 136
- Power sockets
- trailer ..... 306
- Power steering
- see Electromechanical steering ..... 240
- Preheating system
- control lamp ..... 315
- Preheat the engine ..... 227
- Press & Drive
- start button ..... 226
- starting the engine ..... 227
- R**
- Radar sensors ..... 253, 257
- Radio
- frequency change ..... 170
- indications and icons ..... 170
- main menu ..... 170
- preset buttons ..... 173
- save station logos ..... 173
- RADIO
- additional DAB services ..... 172
- additional DAB stations ..... 172
- automatic playback (SCAN) ..... 175
- DAB memories ..... 172
- DAB operation ..... 172
- DAB radio text ..... 172
- DAB slideshow ..... 172
- DAB station information ..... 172
- DAB transmission standards ..... 172
- indication of station names ..... 171
- radio text (RDS) ..... 171
- RDS ..... 171
- selecting, tuning and saving stations ..... 174
- set a station name ..... 171
- settings ..... 176
- station tracking by RDS ..... 171
- tracking of DAB stations on FM ..... 172
- traffic information (TP) ..... 175
- Radio-operated remote control
- see Keys ..... 85
- Radio screen: clean ..... 346
- Radio telephones ..... 349
- Radio text (RDS) ..... 171
- Rain sensor ..... 116
- function control ..... 116
- Raise the vehicle ..... 43
- RCTA ..... 273
- see Rear cross traffic alert (RCTA) ..... 269
- RDS ..... 171
- automatic station tracking ..... 171
- RDS Regional ..... 171
- Rear cross traffic alert (RCTA) ..... 269, 273
- control lamp ..... 270
- Rear fog light
- control lamp ..... 107
- Rear lid ..... 98, 102
- see also Luggage compartment ..... 99
- Rear mounting
- towing device ..... 312
- Rear parking aid ..... 294
- Rear Traffic Alert ..... 273
- Rear View Camera ..... 300
- Rear window wiper ..... 114
- Recognition of road signs ..... 205
- Refuelling ..... 313
- control lamp ..... 73
- fuel gauge ..... 73
- opening the fuel tank flap ..... 313
- Releasing the seat belt ..... 18
- Remote control key
- unlock and lock ..... 89
- Repair work ..... 348
- Reverse assist ..... 300
- display ..... 301
- parking ..... 302
- special characteristics ..... 301
- usage instructions ..... 301
- Reverse assist system ..... 300
- Reverse (automatic gearbox) ..... 233
- Revolution counter ..... 63, 73
- Road signs
- shown on the display ..... 70
- Road signs detection system ..... 70
- how it works ..... 70
- limited operation ..... 72
- shown on the display ..... 70
- speed warning ..... 71

- trailer ..... 71
- windscreen damage ..... 72
- Roof carrier ..... 131
  - fix the crossbars ..... 131
- Roof carrier system ..... 131
- Roof rack ..... 131
- Rotary/push knobs ..... 150
- Rotation direction
  - tyres ..... 44
- Running in
  - new brake pads ..... 275
  - new engine ..... 243
  - new tyres ..... 330
- S**
- Safe ..... 228
- Safe driving ..... 11
- Safe security system ..... 93
- Safety
  - child safety ..... 28
  - child seats ..... 28
  - safe driving ..... 11
- Safety equipment ..... 11
- Safety instructions
  - head-protection airbags ..... 28
  - seat belt tensioners ..... 20
  - side airbags ..... 27
  - using child seats ..... 30
  - using seat belts ..... 16
- Save fuel
  - inertia mode ..... 237
- Seat belts ..... 15
  - adjustment ..... 18
  - control lamp ..... 15
  - fitting the seat belt strap ..... 19
  - protective function ..... 16
  - purpose ..... 15, 21
  - safety instructions ..... 16
  - unfastened ..... 17
- Seat belt tensioners ..... 20
  - control lamp ..... 23
- Seat heating ..... 142
- Seats
  - adjusting the headrests ..... 122
  - electric settings ..... 120
  - fitting the headrest ..... 122
  - folding down and raising the rear seat
    - backrest ..... 123
    - heating ..... 142
  - incorrect positions ..... 13
  - manual adjustment ..... 120
  - number of seats ..... 13
  - removing the headrest ..... 122
- Selective unlocking system ..... 89
- Selector lever lock ..... 233
- Selector lever (automatic gearbox)
  - emergency unlocking ..... 238
  - positions ..... 232
- Service
  - Digital Maintenance plan ..... 340
  - flexible service ..... 340
  - inspection ..... 340
  - oil change service ..... 340
  - proof of Service ..... 340
  - services ..... 340
  - service sets ..... 342
  - service works ..... 340
  - set service intervals ..... 340
  - terms of use ..... 341
- Service interval display ..... 66, 341
- Service intervals ..... 75
- Service Menu
  - identifying letters on engine ..... 66
  - restart the oil service ..... 66
  - restart Trip ..... 66
  - service intervals display ..... 66
  - time ..... 66
- Service Mobility ..... 342
- Service notification: consult ..... 75
- Set of vehicle keys ..... 85
- Shift paddles (automatic transmission) ..... 234
- Side airbags
  - safety instructions ..... 27
- SMS ..... 220
- Snow chains ..... 336
  - four-wheel drive ..... 244
- Spanner symbol ..... 75
- Spare parts ..... 348
- Special characteristics
  - AUX mode ..... 189
  - high pressure cleaning equipment ..... 311
  - peripheral view system (Top View Camera) ..... 298
  - towing ..... 48, 50
  - tow start ..... 48
  - trailer mode ..... 308
  - volume reduction ..... 150
- Speed limiter ..... 248
  - control lamp ..... 248
  - indication on display ..... 249
  - operating ..... 250, 251
- Speed symbol ..... 331
- Speed warning ..... 68
- Sport Mode ..... 281

- SSD  
 see Jukebox (SSD) ..... 190
- Stabilisation of the towing vehicle and trailer  
 combination ..... 309
- Start-Stop ..... 230
- Start-Stop system  
 disconnect and connect ..... 232  
 driver indications ..... 230  
 how it works ..... 230  
 lamps ..... 230  
 stopping and starting the engine ..... 230  
 the engine does not turn off ..... 230  
 the engine starts by itself ..... 230
- Starter button ..... 226
- Start the engine by towing ..... 48  
 special characteristics ..... 48
- Station  
 set a station name ..... 171
- Station names ..... 171
- Station tracking ..... 171
- Status display ..... 66  
 adaptive cruise control ..... 257  
 compass indication ..... 66  
 doors, bonnet and rear lid open ..... 65  
 Drive Profile ..... 241  
 Emergency brake assistance system (Front Assist) ..... 251  
 gear-change recommendation ..... 65  
 instrument panel ..... 65  
 odometer ..... 65  
 outside temperature ..... 65  
 road signs ..... 70  
 selector lever positions ..... 65, 232  
 service intervals ..... 75  
 speed limiter ..... 249
- speed warning ..... 65
- time ..... 73
- tyre control ..... 337
- warning and information messages ..... 68
- Steering  
 control lamp ..... 241  
 electromechanical steering ..... 240  
 steering assist ..... 240
- Steering assist ..... 240
- Steering wheel  
 adjust ..... 14  
 controls ..... 83  
 shift paddles (automatic transmission) ..... 234
- Storage compartment ..... 132  
 drawers ..... 133  
 glove compartment ..... 133  
 glove compartment light ..... 114  
 on-board documentation ..... 133  
 on the front passenger side ..... 133  
 other object holders ..... 134
- Storage compartment accessories  
 see Storage ..... 132
- Storage of accident data ..... 351
- Storing objects ..... 124  
 bag hooks ..... 130  
 fastening rings ..... 128  
 loading the trailer ..... 307  
 net bag ..... 129  
 positioning the load ..... 124  
 positioning the luggage ..... 124  
 roof carrier ..... 131  
 roof carrier system ..... 131, 132  
 trailer ..... 303  
 trailer mode ..... 308  
 trapdoor for transporting long objects ..... 130
- Sun blind ..... 119
- Sun protection ..... 119
- Sunroof ..... 104  
 anti-trap function ..... 106  
 closing ..... 105  
 malfunction ..... 105  
 opening ..... 105  
 sunshade blind ..... 105
- Sunshade blind  
 anti-trap function (glass roof) ..... 106  
 sunroof ..... 105
- Switch  
 hazard warning lights ..... 112
- T**
- Tail lights  
 change a bulb ..... 56
- Tail lights on the bodywork  
 remove the tail light ..... 57
- Tail lights on the rear lid  
 remove the bulb holder ..... 58
- Technical data ..... 355  
 fuel consumption ..... 355  
 load on the roof ..... 132  
 vehicle dimensions ..... 358  
 vertical load on the tow hitch ..... 303  
 weights ..... 355
- Technical modifications ..... 349
- Telephone  
 Bluetooth® profiles ..... 214  
 Bluetooth® settings ..... 222  
 call lists ..... 221  
 enter telephone number ..... 218  
 favourites (quick access to the phone book) ..... 221

- general information ..... 213
- indications and symbols ..... 217
- main menu ..... 216
- pairing a mobile phone ..... 215
- phonebook ..... 219
- places with special regulations ..... 214
- settings ..... 222
- short messages (SMS) ..... 220
- user profile settings ..... 223
- voice control ..... 156
- Temperature indicator
  - exterior ..... 65
- Time
  - adjust ..... 66, 73
- Tiptronic (automatic transmission) .... 232, 234
- To change the battery
  - of the vehicle key ..... 86
- To park the vehicle ..... 282
- Top Tether ..... 33, 35, 36
- Top Tether System ..... 33, 35, 36
- Top View Camera
  - see the Peripheral view system (Top View Camera) ..... 296
- Torque
  - wheel nuts ..... 44
- Towable loads
  - loading the trailer ..... 307
- Tow cable ..... 305, 306
- Tow hook
  - control lamp ..... 310
  - unlocking electrically ..... 310
- Towing device
  - fitting a bicycle carrier ..... 311
  - fitting later ..... 312
- malfunction ..... 307
- tow hook with electric unlocking ..... 310
- Towing the vehicle ..... 48, 50
  - automatic gearbox ..... 49, 50
  - four-wheel drive ..... 49
  - front towline anchorage ..... 51
  - manual gearbox ..... 49, 50
  - rear towline anchorage ..... 51
  - special characteristics ..... 48, 50
  - tow bar ..... 49
  - towing cable ..... 49
  - towing prohibited ..... 49
  - with towing device ..... 49
- Traction control system ..... 279
- Traffic Jam Assist ..... 266
  - malfunction ..... 268
  - situations where it has to be disconnected ..... 267
- Trailer ..... 303
  - adjusting the headlights ..... 308
  - anti-theft alarm ..... 306
  - blind spot detector (BSD) ..... 274
  - connecting ..... 305
  - exterior mirrors ..... 305
  - hitching ..... 305
  - LED tail lights ..... 305, 306
  - loading ..... 307
  - malfunction ..... 307
  - parking aid ..... 294, 295
  - power socket ..... 306
  - retrofitting a towing bracket ..... 312
  - special characteristics ..... 274
  - stabilisation of the towing vehicle and trailer combination ..... 309
  - tail lights ..... 305, 306
  - technical requirements ..... 304
  - towable loads ..... 307
  - towing cable ..... 305, 306
  - trailer mode ..... 308
  - unlocking the tow hook electrically ..... 310
  - vertical load on the tow hitch ..... 303, 307
- Trailer mode
  - see Trailer ..... 303
- Transportation of children ..... 28
- Trapdoor for transporting long objects ..... 130
- Trips abroad
  - headlights ..... 113
  - petrol ..... 246
- Turning off the lights ..... 107
- Turning on the lights ..... 107
- Turn signal lever ..... 109
- Tyre Mobility System
  - see Anti-puncture kit ..... 38
- Tyre monitor system ..... 337
- Tyre pressure ..... 333
  - tyre pressure loss indicator ..... 337
- Tyre profile ..... 334
- Tyre repair kit ..... 38
  - see also Anti-puncture kit ..... 38
- Tyre repairs ..... 38
- Tyres ..... 330
  - accessories ..... 331
  - change ..... 41
  - directional tread pattern ..... 44
  - foreign objects inserted ..... 331
  - new tyres ..... 331
  - speed symbol ..... 331
  - tread wear indicators ..... 334
  - tyre pressure ..... 333

- useful life ..... 333  
 with directional tread pattern ..... 331  
 Tyre tread depth ..... 334  
 Tyre wear ..... 334
- U**
- Unlock and lock  
 by remote control ..... 89  
 doors ..... 96  
 with Keyless Access ..... 90  
 with the central locking switch ..... 89  
 USB ..... 224  
 connecting external data media ..... 187  
 error messages ..... 188  
 USB/AUX-IN input ..... 224
- V**
- Vanity mirror ..... 119  
 Variable luggage compartment floor ..... 127  
 Vehicle  
 data label ..... 355  
 identification data ..... 355  
 identification number ..... 355  
 parking on inclines ..... 282  
 parking on upward slopes ..... 282  
 raise ..... 43  
 unlocking and locking with Keyless Access ..... 90  
 vehicle ID number ..... 355  
 Vehicle battery ..... 326  
 assisted start ..... 46  
 charge level ..... 328  
 charging ..... 327  
 disconnect and connect ..... 76, 326  
 electrolyte level ..... 327  
 energy management ..... 328  
 replacement ..... 327  
 winter operations ..... 326  
 Vehicle care  
 wiper blade service position ..... 45  
 Vehicle conservation products ..... 343  
 Vehicle dimensions ..... 358  
 Vehicle maintenance ..... 343  
 Vehicle seats ..... 13  
 Vehicle tool kit ..... 38  
 Vehicle wallet compartment ..... 133  
 Vertical load on the tow hitch ..... 303  
 loading the trailer ..... 307  
 Voice control  
 available languages ..... 156
- W**
- Warning lamps  
 engine coolant ..... 74  
 Warning symbols  
 see Control and warning lamps ..... 77  
 Warning triangle ..... 112  
 Warranty ..... 343  
 Washing the vehicle  
 conserving the exterior of the vehicle ..... 343  
 high pressure cleaning equipment ..... 343  
 sensors ..... 283  
 special characteristics ..... 101  
 Weights ..... 355  
 Welcome light ..... 112  
 Wheel balance ..... 333  
 Wheel nuts ..... 42, 335  
 anti-theft device ..... 42  
 caps ..... 41  
 torque ..... 44  
 Wheels ..... 330  
 change ..... 41, 44  
 changing ..... 334  
 changing a wheel ..... 41  
 new wheels ..... 331  
 snow chains ..... 336  
 spare wheel ..... 338  
 Wheel spanner ..... 38  
 Wheel trim  
 remove ..... 41  
 Window controls ..... 102  
 Windows  
 automatic opening/closing ..... 103  
 automatic operation ..... 103  
 convenience closing ..... 103  
 convenience opening ..... 103  
 Window washer  
 window washer lever ..... 114  
 Window washer system ..... 325  
 Window washer water  
 check ..... 325  
 filling quantities ..... 325  
 refill ..... 325  
 Windscreen  
 heating ..... 142  
 Windscreen heating ..... 138, 142  
 Windscreen washer ..... 114  
 Windscreen wipers ..... 114  
 functions ..... 115  
 headlight washer system ..... 115  
 lift the blade ..... 45  
 rain sensor ..... 116  
 reposition the blade ..... 45  
 service position ..... 45



special characteristics .....	115
thermal washing ejectors .....	115
Winter conditions	
sunroof .....	104
trailer .....	303
Winter tyres .....	335
four-wheel drive .....	244
Wiper and rear window wiper blades	
cleaning .....	45
replacement .....	45
service position .....	45
Wiper blades	
cleaning .....	345
Wireless Charger .....	224
WLAN .....	167
connect external audio source .....	191

## X

XDS .....	280
-----------	-----

## Other Characters

(TP) Traffic information .....	175
--------------------------------	-----



SEAT S.A. is permanently concerned about continuous development of its types and models. For this reason we ask you to understand, that at any given time, changes regarding shape, equipment and technique may take place on the car delivered. For this reason no right at all may derive based on the data, drawings and descriptions in this current handbook.

All texts, illustrations and standards in this handbook are based on the status of information at the time of printing. Except for error or omission, the information included in the current handbook is valid as of the date of closing print.

Re-printing, copying or translating, whether total or partial is not allowed unless SEAT allows it in written form.

SEAT reserves all rights in accordance with the "Copyright" Act.

All rights on changes are reserved.

 This paper has been manufactured using bleached non-chlorine cellulose.

© SEAT S.A. - Reprint: 15.07.19

Inglés 575012720BL (07.19)



575012720BL

